

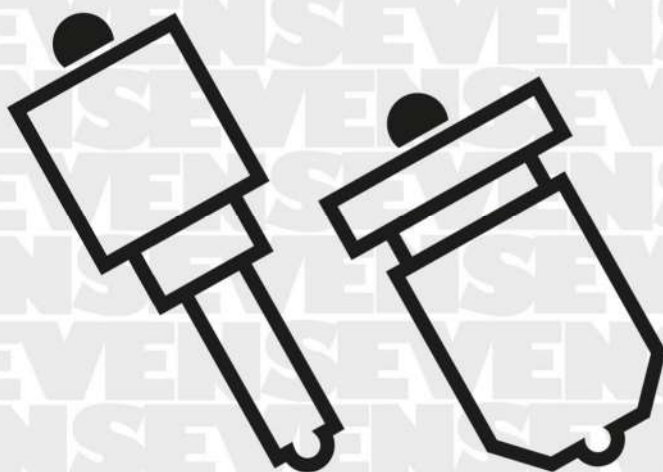

# CATALOGUE

AUTOMOTIVE AND LARGE ENGINES  
NOZZLES AND PARTS

2026/04



## Index

- American Bosch
- Belarus-Kamaz
- Bendix
- Bosch
- B&W Burmeister & Wain
- Caterpillar
- Cummins
- Delphi
- Denso
- Detroit Diesel
- Doowon
- F&M
- Fiat - Iveco
- Ford-Navistar
- GMT
- HiMSEN
- Lucas-Bryce
- Lucas-Simms
- MaK
- MAN
- Motorpal
- OMAP
- Perkins
- Ruston
- Seven Diesel
- Siemens VDO
- Sigma
- SKL
- Stanadyne
- Steyr
- Sulzer
- Wartsila
- Woodward-L'Orange
- Yanmar
- Zexel

CP = flow tested nozzle with EDM holes

DLC (Diamond-Like Carbon) = needle with special black coating

D/A = two diameter needle

**Important notice.** All the parts herein are manufactured by Seven Diesel S.p.A.. Other manufacturer's names, symbols, code numbers are quoted for reference purposes only and do not imply that any part listed in this catalogue is the product of these manufacturers. Our products have no concern with genuine products and are not certified by IMO.

Our Ref.	Stamping	Part Number	CP	DLC	D/A	Technical Data	Description
----------	----------	-------------	----	-----	-----	----------------	-------------

## American Bosch

77963	ADB150S 103					4x0,33x150°	Nozzle
77970	ADB35S 124-7					1x0.45+1x0.40	Nozzle
77971	ADB135S 126-7					8x0,28x135°	Nozzle
77976	ADB155S 153-6					5x0,33x155°	Nozzle
77977	ADB155S 153-7					5x0,32x155°	Nozzle
77978	ADB150S 155-6					5x0,27x150°	Nozzle
77981	ADB30S 156-7					1x0.69x30°	Nozzle
77987	ADB135S 194-12					8x0.29x135°	Nozzle
NAB10421	ADL157TM 821-6					9x0,35x157°	Nozzle
NAB10422	ADL157TM 822-6					9x0,375x157°	Nozzle
NAB10427	ADL145TM 827-6	123x1053				9x0,375x145°	Nozzle
NAB10429	ADL145TM 829-6	22310227-2				9x0,35x145°	Nozzle
NAB10432	ADL145TM 830-6					9x0,40x145°	Nozzle
NAB10436	ADL145TM 836-6	H145T32K648				9x0,325x145°	Nozzle
NAB10440	ADL160TM 840-6	H160T37K904AP7				9x0,375x160°	Nozzle
NAB10442	ADL160TM 842-6	22310234				9x0,325x160°	Nozzle

## B&W

NBW40600	4-600-0254	B&W				5x1,3	Nozzle
NBW40975	1324975-9	B&W				5x0,52	Nozzle
NBW40976	17001599-7	B&W				5x0,62	Nozzle
NBW41395	577 32970 95	B&W				3x0,95	Nozzle

## Belarus-Kamaz

78000	11-1112110-A	BR 80				4x0,29x128°	Nozzle
78002	H3TA	16-1112110-A				3x0.35x130°	Nozzle
78004	01-86-236					4x0,34x160°	Nozzle
78005	B3TA 5x0,32	B3TA				5x0,32x121°	Nozzle
780088	174-02	02.10				5x0,34x123°	Nozzle
780093	273-20					5x0,31x151°	Nozzle
78010	19243					4x0.33x144°	Nozzle
78011C	BR171-02	05.07.A3NN				5x0,39x124°	Nozzle

## Bendix

NBX1098	10-9041360-1	123x1098					Nozzle
NBX60032	10-328310	123x1052				1x2,30	Nozzle
NBX60101	10-83547-2	123x1009				1x2.0	Nozzle

## Bosch

40001	DN4S 1	0434 200 001					Pintle Nozzle
400024	DN4S 2	0434 200 002					Pintle Nozzle
400028	DN8S 2	0434 200 012					Pintle Nozzle
40003	DN8S 3	0434 200 013					Pintle Nozzle
40012	DN12SD 12	0434 250 027					Pintle Nozzle
40021	DN0SD 21	0434 250 001					Pintle Nozzle
40024	DN4SD 24	0434 250 014					Pintle Nozzle
40126	DN0SD 126	0434 250 002					Pintle Nozzle
40130	DN0SD 130	0434 250 004					Pintle Nozzle
40138	DN8S 138	0434 200 998					Pintle Nozzle
40156	DN15S 156	0434 200 021					Pintle Nozzle
40165	DN0SD 165	0434 250 037					Pintle Nozzle
40174	DN0SD 174	0434 250 046					Pintle Nozzle
40188	DN0SD 189	0434 250 060					Pintle Nozzle
401891	DN0SD 189/	0434 250 122					Pintle Nozzle

<i>Our Ref.</i>	<i>Stamping</i>	<i>Part Number</i>	<i>CP</i>	<i>DLC</i>	<i>D/A</i>	<i>Technical Data</i>	<i>Description</i>
<b>40193</b>	DN0SD 193	0434 250 063					Pintle Nozzle
<b>40195</b>	DN0SD 195	0434 250 065					Pintle Nozzle
<b>40197</b>	DN6S 197	0434 200 034					Pintle Nozzle
<b>40211</b>	DN0SD 211	0434 250 009					Pintle Nozzle
<b>40220</b>	DN0SD 220	0434 250 072					Pintle Nozzle
<b>40221</b>	DN12SD 221	0434 250 090					Pintle Nozzle
<b>40230</b>	DN0SD 230	0434 250 077					Pintle Nozzle
<b>40240</b>	DN0SD 240	0434 250 110					Pintle Nozzle
<b>40242</b>	DN10S 242	0434 200 053					Pintle Nozzle
<b>40248</b>	DN0SD 248	0434 250 105					Pintle Nozzle
<b>402521</b>	DN0SD 252+	0434 250 134					Pintle Nozzle
<b>402522</b>	DN0SD 252+/ /	0434 250 164					Pintle Nozzle
<b>40256</b>	DN0SD 256	0434 250 114					Pintle Nozzle
<b>40259</b>	DN0SD 259	0434 250 117					Pintle Nozzle
<b>40261</b>	DN0SD 261	0434 250 120					Pintle Nozzle
<b>40263</b>	DN0SD 263	0434 250 125					Pintle Nozzle
<b>40264</b>	DN0SD 264	0434 250 127					Pintle Nozzle
<b>40265</b>	DN0SD 265	0434 250 128					Pintle Nozzle
<b>40267</b>	DN0SD 267	0434 250 130					Pintle Nozzle
<b>40269</b>	DN0SD 269	0434 250 132					Pintle Nozzle
<b>40272</b>	DN0SD 272	0434 250 137					Pintle Nozzle
<b>40273</b>	DN0SD 273	0434 250 138					Pintle Nozzle
<b>40274</b>	DN0SD 274	0434 250 139					Pintle Nozzle
<b>40282</b>	DN0SD 282	0434 250 144					Pintle Nozzle
<b>40286</b>	DN0SD 286	0434 250 148					Pintle Nozzle
<b>402871</b>	DN0SD 287+	0434 250 157					Pintle Nozzle
<b>40288</b>	DN0SD 288	0434 250 150					Pintle Nozzle
<b>40289</b>	DN0SD 289	0434 250 156					Pintle Nozzle
<b>40290</b>	DN12SD 290	0434 250 153					Pintle Nozzle
<b>40292</b>	DN0SD 292	0434 250 154					Pintle Nozzle
<b>40293</b>	DN0SD 293	0434 250 103					Pintle Nozzle
<b>40294</b>	DN0SD 294	0434 250 155					Pintle Nozzle
<b>40296</b>	DN12SD 296	0434 250 158					Pintle Nozzle
<b>40297</b>	DN0SD 297	0434 250 159					Pintle Nozzle
<b>40299</b>	DN0SD 299	0434 250 160					Pintle Nozzle
<b>402991</b>	DN0SD 299A	0434 250 171					Pintle Nozzle
<b>402992</b>	DN0SD 299C	0434 250 193					Pintle Nozzle
<b>40300</b>	DN0SD 300	0434 250 161					Pintle Nozzle
<b>40301</b>	DN0SD 301	0434 250 162					Pintle Nozzle
<b>40302</b>	DN0SD 302	0434 250 163					Pintle Nozzle
<b>403021</b>	DN0SD 302A	0434 250 175					Pintle Nozzle
<b>40306</b>	DN0SD 306	0434 250 167					Pintle Nozzle
<b>40308</b>	DN0SD 308	0434 250 169					2 Springs Nozzle
<b>40309</b>	DN0SD 309	0434 250 170					Pintle Nozzle
<b>40310</b>	DN0SD 310	0434 250 897					Pintle Nozzle
<b>40314</b>	DN0SD 314	0434 250 176					Pintle Nozzle
<b>40322</b>	DN0SD 322	0434 250 226					Pintle Nozzle
<b>40510</b>	DN0SD 1510	0434 250 011					Pintle Nozzle
<b>40750</b>	DN12SD 1750	0434 250 119					Pintle Nozzle
<b>40930</b>	DN0SD 1930	0434 250 092					Pintle Nozzle
<b>40940</b>	DN0SD 2110	0434 250 012					Pintle Nozzle
<b>71000</b>	DLL132S 1	0433 220 013				4x0.25x132°	Nozzle
<b>71001</b>	DLL150S 53	0433 270 020				4x0.24x150°	Nozzle
<b>71002</b>	DLL150S 60	0433 220 033				8x0.23x150°	Nozzle

<i>Our Ref.</i>	<i>Stamping</i>	<i>Part Number</i>	<i>CP</i>	<i>DLC</i>	<i>D/A</i>	<i>Technical Data</i>	<i>Description</i>
<b>71004</b>	DLL110S 103	0433 270 004				3x0,28x110°	Nozzle
<b>71005</b>	DLL160S 136	0433 270 039				4x0,31x160°	Nozzle
<b>710054L</b>	DLL160S 154	0433 270 041				4x0,31x160°	Nozzle
<b>71006</b>	DLL140S 162	0433 220 020				5x0,30x140°	Nozzle
<b>710075L</b>	DLL150S 184	0433 220 058				6x0,31x150°	Nozzle
<b>710076L</b>	DLL150S 188	0433 220 060				7x0,26x150°	Nozzle
<b>71008</b>	DLL160S 202	0433 220 067				7x0,32x160°	Nozzle
<b>71009</b>	DLL150S 211	0433 220 063				4x0,29x150°	Nozzle
<b>71010</b>	DLL140S 217	0433 220 065				4x0,31x140°	Nozzle
<b>71011</b>	DLL150S 219	0433 220 064				5x0,35x150°	Nozzle
<b>71012</b>	DLL50S 226	0433 220 066				3x0,36+2x0,25	Nozzle
<b>71013</b>	DLL140S 248	0433 220 073				4x0,20x140°	Nozzle
<b>71014</b>	DLL145S 258	0433 270 071				4x0,35x145°	Nozzle
<b>71015</b>	DLL160S 267	0433 270 076				4x0,28x150°	Nozzle
<b>710155</b>	DLL50S 278	0433 220 078				3x0,44+2x0,32	Nozzle
<b>71016</b>	DLL120S 285	0433 220 079				6x0,42x120°	Nozzle
<b>71017</b>	DLL145S 317	0433 270 086				4x0,36x145°	Nozzle
<b>71018L</b>	DLL160S 336	0433 220 087				4x0,34x160°	Nozzle
<b>710197</b>	DLL160S 343	0433 220 091				6x0,41x160°	Nozzle
<b>710198</b>	DLL150S 344	0433 220 092				8x0,37x150°	Nozzle
<b>71020</b>	DLL160S 346	0433 220 093				9x0,42x160°	Nozzle
<b>710202C</b>	DLL150S 348	0433 220 095				4x0,39x150°	Nozzle
<b>710217</b>	DLL120S 352	0433 220 097				6x0,36x120°	Nozzle
<b>71022</b>	DLL18S 353	0433 270 102				1x0,57x18°	Nozzle
<b>71025</b>	DLL35S 364	0433 270 106				1x0,72x35°	Nozzle
<b>71027</b>	DLL150S 393	0433 270 114				4x0,30x150°	Nozzle
<b>71028</b>	DLL150S 405	0433 270 116				4x0,40x150°	Nozzle
<b>71029</b>	DLL150S 406	0433 270 117				4x0,30x150°	Nozzle
<b>71030</b>	DLL18S 418	0433 270 121				1x0,61x18°	Nozzle
<b>71032</b>	DLL140S 446	0433 220 109				4x0,39x140°	Nozzle
<b>71033</b>	DLL150S 450	0433 220 110				4x0,30x150°	Nozzle
<b>710334C</b>	DLL150S 464	0433 220 113				4x0,43x150°	Nozzle
<b>710343</b>	DLL150S 508	0433 270 142				4x0,31x150°	Nozzle
<b>71035</b>	DLL140S 522	0433 270 146				4x0,37x140	Nozzle
<b>710359</b>	DLL153S 529	0433 220 123				8x0,28x153°	Nozzle
<b>71036C</b>	DLL150S 530	0433 220 124				5x0,33x150°	Nozzle
<b>710371L</b>	DLL150S 535	0433 220 126				7x0,29x150°	Nozzle
<b>710372L</b>	DLL180S 540	0433 270 148				4x0,29x180°	Nozzle
<b>710375</b>	DLL150S 545	0433 220 128				8x0,25x150°	Nozzle
<b>71038</b>	DLL23S 553	0433 220 129				1x0,61x23°	Nozzle
<b>71039</b>	DLL35S 559	0433 220 130				1x0,67x35°	Nozzle
<b>71040</b>	DLL38S 560	0433 220 131				1x0,72x38°	Nozzle
<b>710401</b>	DLL35S 561	0433 220 132				1x0,61x35°	Nozzle
<b>710402</b>	DLL35S 562	0433 220 133				1x0,66x35°	Nozzle
<b>710406</b>	DLL18S 572	0433 270 150				1x0,60x18°	Nozzle
<b>71041</b>	DLL140S 586	0433 220 140				4x0,42x140°	Nozzle
<b>71042</b>	DLL16S 592	0433 220 141				1x0,61x16°	Nozzle
<b>710421</b>	DLL150S 606	0433 220 143				4x0,42x150°	Nozzle
<b>710423</b>	DLL140S 610	0433 270 157				4x0,29x140°	Nozzle
<b>710424</b>	DLL150S 612	0433 270 159				4x0,25x150°	Nozzle
<b>710427</b>	DLL18S 629	0433 270 162				1x0,62x18°	Nozzle
<b>710429</b>	DLL150S 631	0433 220 147				8x0,31x150°	Nozzle
<b>71043</b>	DLL140S 632	0433 220 148				4x0,45x140°	Nozzle
<b>710431</b>	DLL25S 680	0433 270 168				1x0,38+1x0,43	Nozzle

<i>Our Ref.</i>	<i>Stamping</i>	<i>Part Number</i>	<i>CP</i>	<i>DLC</i>	<i>D/A</i>	<i>Technical Data</i>	<i>Description</i>
<b>71044L</b>	DLL160S 705	0433 270 170				4x0,30x160°	Nozzle
<b>710450</b>	DLL160S 721	0433 220 155				4x0,37x160°	Nozzle
<b>710451</b>	DLL120S 736	0433 220 157				2x0,36+3x0,50	Nozzle
<b>710452</b>	DLL152S 756	0433 220 160				5x0,52x152°	Nozzle
<b>710453</b>	DLL152S 780	0433 220 163				5x0,55x152°	Nozzle
<b>710456</b>	DLL25S 834	0433 270 176				1x0,65x25°	Nozzle
<b>71046</b>	DLL28S 932	0433 270 182				1x0,71x28°	Nozzle
<b>710462</b>	DLL155S 942	0433 220 173				4x0,38x155°	Nozzle
<b>710463L</b>	DLL150S 979	0433 220 182				6x0,26x158°	Nozzle
<b>710464</b>	DLL110S 1030	9430 034 205				3x0,28x110°	Nozzle
<b>710467</b>	DLL155S 1057	0433 220 190				7x0,41x155°	Nozzle
<b>710468L</b>	DLL150S 1093	0433 220 195				8x0,32x150°	Nozzle
<b>710469</b>	DLL155S 1271	0433 270 191				8x0,31x155°	Nozzle
<b>7104695</b>	DLL155S 1383	0433 272 038				8x0,27x155°	Nozzle
<b>71047</b>	DLL150S 2641	0433 270 120				4x0,29x150°	Nozzle
<b>71048</b>	DLL155S 4820	0433 270 161				5x0,33x155°	Nozzle
<b>71056</b>	DLLA154S 016	F019 122 016				4x0,315x154°	Nozzle
<b>71058C</b>	DLLA155S 054	F019 122 054				5x0,30x155°	Nozzle
<b>71060</b>	DLLA27S 50	0433 271 013				2x0,41x27°	Nozzle
<b>71064</b>	DLLA25S 64	0433 271 009				2x0,305x25°	Nozzle
<b>71065</b>	DLLA30S 69	0433 271 019				2x0,30x30°	Nozzle
<b>71070</b>	DLLA27S 88	0433 271 016				2x0,42x27°	Nozzle
<b>71071</b>	DLLA20S 102	0433 271 005				2x0,36x20°	Nozzle
<b>710719</b>	DLLA20S 110	0433 271 006				2x0,35x20°	Nozzle
<b>71072</b>	DLLA150S 111	0433 271 027				4x0,31x150°	Nozzle
<b>71073</b>	DLLA25S 116	0433 271 012				2x0,0295x25°	Nozzle
<b>71075</b>	DLLA38S 133	0433 271 022				2x0,52x38°	Nozzle
<b>71076</b>	DLLA10S 134	0433 271 001				2x0,42x10°	Nozzle
<b>71077</b>	DLLA150S 138	0433 271 030				4x0,36x150°	Nozzle
<b>71078</b>	DLLA150S 140	0433 271 032				4x0,31x150°	Nozzle
<b>71079</b>	DLLA23S 155	0433 271 008				1x0,53x23°	Nozzle
<b>71080</b>	DLLA35S 161	0433 271 021				1x0,60x35°	Nozzle
<b>710803</b>	DLLA25S 169	0433 271 038				1x0,43x25°	Nozzle
<b>710805</b>	DLLA35S 175	0433 271 041				1x0,66x35°	Nozzle
<b>71081</b>	DLLA150S 178	0433 271 043				4x0,35x150°	Nozzle
<b>71082</b>	DLLA150S 186	0433 271 045				4x0,39x150°	Nozzle
<b>71083</b>	DLLA150S 187	0433 271 046				4x0,32x150°	Nozzle
<b>71084</b>	DLLA150S 190	0433 271 048				4x0,29x150°	Nozzle
<b>71085</b>	DLLA23S 191	0433 271 049				1x0,61x23°	Nozzle
<b>71086</b>	DLLA145S 199	0433 271 055				4x0,26x145°	Nozzle
<b>71087</b>	DLLA150S 204	0433 271 058				4x0,34x150°	Nozzle
<b>710875</b>	DLLA38S 208	0433 271 060				1x0,75x38°	Nozzle
<b>71089</b>	DLLA150S 223	0433 271 067				4x0,29x150°	Nozzle
<b>71091</b>	DLLA150S 236	0433 271 071				4x0,24x150°	Nozzle
<b>71094</b>	DLLA140S 254	0433 271 172				4x0,33x140°	Nozzle
<b>71095L</b>	DLLA160S 255	0433 271 079				4x0,29x160°	Nozzle
<b>710961</b>	DLLA150S 269	0433 271 086				4x0,35x150°	Nozzle
<b>710964</b>	DLLA150S 274	0433 271 092				3x0,45x150°	Nozzle
<b>710967</b>	DLLA10S 286	0433 271 099				2x0,42x10°	Nozzle
<b>710968</b>	DLLA150S 288	0433 271 100				4x0,24x150°	Nozzle
<b>71097</b>	DLLA150S 292	0433 271 103				5x0,33x150°	Nozzle
<b>71098</b>	DLLA38S 293	0433 271 104				1x0,70x38°	Nozzle
<b>71099</b>	DLLA28S 297	0433 271 106				1x0,43x28°	Nozzle
<b>710995</b>	DLLA140S 305	0433 271 112				4x0,28x140°	Nozzle

<i>Our Ref.</i>	<i>Stamping</i>	<i>Part Number</i>	<i>CP</i>	<i>DLC</i>	<i>D/A</i>	<i>Technical Data</i>	<i>Description</i>
<b>71100</b>	DLLA153S 308	0433 271 114				4x0,29x153°	Nozzle
<b>71101</b>	DLLA28S 310	0433 271 117				1x0,61x28°	Nozzle
<b>71102</b>	DLLA28S 312	0433 271 118				1x0,56x28°	Nozzle
<b>71110</b>	DLLA35S 376	0433 271 150				1x0,70x35°	Nozzle
<b>71111</b>	DLLA35S 377	0433 271 151				1x0,71x35°	Nozzle
<b>71112</b>	DLLA160S 378	0433 271 152				4x0,26x160°	Nozzle
<b>711124</b>	DLLA23S 383	0433 271 155				1x0,61x23°	Nozzle
<b>71113L</b>	DLLA150S 386	0433 271 157				4x0,36x150°	Nozzle
<b>71114</b>	DLLA79S 390	0433 271 160				4x0,37x79°	Nozzle
<b>71115L</b>	DLLA150S 392	0433 271 161				3x0,36x150°	Nozzle
<b>71116</b>	DLLA149S 394	0433 271 162				4x0,29x149°	Nozzle
<b>71117</b>	DLLA150S 396	0433 271 164				3x0,29x150°	Nozzle
<b>71118</b>	DLLA150S 402	0433 271 169				4x0,42x150°	Nozzle
<b>71119</b>	DLLA28S 414	0433 271 177				2x0,48x28°	Nozzle
<b>71120</b>	DLLA150S 417	0433 271 180				4x0,31x150°	Nozzle
<b>711209</b>	DLLA150S 421	0433 271 183				4x0,37x150°	Nozzle
<b>71121</b>	DLLA150S 422	0433 271 184				3x0,33x150°	Nozzle
<b>71123</b>	DLLA28S 441	0433 271 201				2x0,44x28°	Nozzle
<b>711231</b>	DLLA150S 442	0433 271 195				4x0,32x150°	Nozzle
<b>71125</b>	DLLA150S 456	0433 271 205				4x0,32x150°	Nozzle
<b>71126</b>	DLLA150S 467	0433 271 212				4x0,31x150°	Nozzle
<b>71127</b>	DLLA150S 469	0433 271 214				4x0,29x150°	Nozzle
<b>711275</b>	DLLA150S 475	0433 271 217				4x0,31x150°	Nozzle
<b>71128</b>	DLLA144S 485	0433 271 221				4x0,38x144°	Nozzle
<b>711288</b>	DLLA144S 488	0433 271 222				4x0,40x144°	Nozzle
<b>71129</b>	DLLA149S 490	0433 271 223				4x0,30x149°	Nozzle
<b>71130</b>	DLLA150S 494	0433 271 224				5x0,25x150°	Nozzle
<b>711305</b>	DLLA150S 501	0433 271 229				4x0,29x150°	Nozzle
<b>71131L</b>	DLLA150S 506	0433 271 230				4x0,31x150°	Nozzle
<b>711321</b>	DLLA145S 507	0433 271 231				4x0,28x145°	Nozzle
<b>71133</b>	DLLA160S 509	0433 271 232				4x0,29x160°	Nozzle
<b>71134</b>	DLLA27S 512	0433 271 233				2x0,46x27°	Nozzle
<b>711352L</b>	DLLA150S 515	0433 271 236				3x0,39x150°	Nozzle
<b>71136</b>	DLLA27S 517	0433 271 238				1x0,65x27°	Nozzle
<b>71138L</b>	DLLA150S 523	0433 271 241				4x0,37x150°	Nozzle
<b>71139</b>	DLLA160S 526	0433 271 244				5x0,31x160°	Nozzle
<b>711391</b>	DLLA150S 527	0433 271 245				4x0,30x150°	Nozzle
<b>71140</b>	DLLA152S 533	0433 271 246				4x0,27x152°	Nozzle
<b>71141</b>	DLLA38S 541	0433 271 252				1x0,75x38°	Nozzle
<b>71142</b>	DLLA150S 548	0433 271 258				5x0,32x150°	Nozzle
<b>71143</b>	DLLA150S 549	0433 271 259				5x0,27x150°	Nozzle
<b>711435</b>	DLLA150S 550	0433 271 260				4x0,32x150°	Nozzle
<b>71144</b>	DLLA155S 551	0433 271 261				4x0,23x155°	Nozzle
<b>71145</b>	DLLA160S 555	0433 271 263				4x0,29x160°	Nozzle
<b>71147</b>	DLLA160S 557	0433 271 265				5x0,25x160°	Nozzle
<b>711473L</b>	DLLA140S 563	0433 271 266				3x0,45x140°	Nozzle
<b>71148</b>	DLLA140S 567	0433 271 269				4x0,28x140°	Nozzle
<b>711481</b>	DLLA155S 568	0433 271 270				3x0,44x155°	Nozzle
<b>71149</b>	DLLA155S 574	0433 271 274				4x0,33x155°	Nozzle
<b>711491L</b>	DLLA160S 575	0433 271 275				4x0,40x160°	Nozzle
<b>71150</b>	DLLA150S 582	0433 271 280				4x0,41x150°	Nozzle
<b>71151</b>	DLLA150S 583	0433 271 281				4x0,27x150°	Nozzle
<b>711519</b>	DLLA150S 588	0433 271 284				4x0,30x150°	Nozzle
<b>71152</b>	DLLA28S 589	0433 271 285				1x0,58x28°	Nozzle

<i>Our Ref.</i>	<i>Stamping</i>	<i>Part Number</i>	<i>CP</i>	<i>DLC</i>	<i>D/A</i>	<i>Technical Data</i>	<i>Description</i>
<b>711521</b>	DLLA155S 593	0433 271 287				3x0,41x155°	Nozzle
<b>711529</b>	DLLA28S 600	0433 271 292				2x0,46x28°	Nozzle
<b>71153</b>	DLLA25S 601	0433 271 293				1x0,64x25°	Nozzle
<b>711531</b>	DLLA150S 602	9430 084 202				5x0,47x150°	Nozzle
<b>71154</b>	DLLA150S 607	0433 271 294				4x0,30x150°	Nozzle
<b>711541L</b>	DLLA160S 608	0433 271 295				4x0,28x160°	Nozzle
<b>71155</b>	DLLA27S 613	0433 271 296				1x0,67x27°	Nozzle
<b>71156</b>	DLLA25S 614	0433 271 297				1x0,60x25°	Nozzle
<b>71157</b>	DLLA150S 615	0433 271 298				5x0,31x150°	Nozzle
<b>71158</b>	DLLA150S 616	0433 271 299				5x0,35x150°	Nozzle
<b>71159</b>	DLLA150S 618	0433 271 300				4x0,38x150°	Nozzle
<b>71160</b>	DLLA140S 619	0433 271 301				4x0,40x140°	Nozzle
<b>711602C</b>	DLLA150S 620					5x0,26x150°	Nozzle
<b>711609</b>	DLLA160S 626	0433 271 305				4x0,35x160°	Nozzle
<b>71161</b>	DLLA25S 627	0433 271 306				1x0,66x25°	Nozzle
<b>711615</b>	DLLA150S 628	0433 271 307				4x0,36x150°	Nozzle
<b>71162</b>	DLLA160S 630	0433 271 308				4x0,39x160°	Nozzle
<b>711629</b>	DLLA150S 633	0433 271 309				4x0,33x150°	Nozzle
<b>71163</b>	DLLA150S 634	0433 271 310				4x0,41x150°	Nozzle
<b>71164</b>	DLLA140S 637	0433 271 313				4x0,41x140°	Nozzle
<b>711643</b>	DLLA110S 639	F002 C30 142				3x0,28x110°	Nozzle
<b>711645L</b>	DLLA160S 641	0433 271 315				4x0,36x160°	Nozzle
<b>71166</b>	DLLA155S 651	0433 271 318				5x0,32x155°	Nozzle
<b>711663</b>	DLLA150S 653	0433 271 319				4x0,36x150°	Nozzle
<b>711669</b>	DLLA142S 655	0433 271 321				4x0,39x142°	Nozzle
<b>71167</b>	DLLA28S 656	0433 271 322				2x0,45x28°	Nozzle
<b>711681C</b>	DLLA155S 658	0433 271 898				4x0,35x155°	Nozzle
<b>711682L</b>	DLLA141S 662	0433 271 325				3x0,35x141°	Nozzle
<b>711684</b>	DLLA150S 666	0433 271 327				4x0,39x150°	Nozzle
<b>711686</b>	DLLA150S 671	0433 271 329				4x0,29x150°	Nozzle
<b>71169</b>	DLLA140S 677	0433 271 333				5x0,28x140°	Nozzle
<b>71170</b>	DLLA30S 678	0433 271 334				1x0,75x30°	Nozzle
<b>711701</b>	DLLA150S 679	0433 271 335				4x0,43x150°	Nozzle
<b>711703C</b>	DLLA155S 681	0433 271 895				4x0,37x155°	Nozzle
<b>711705L</b>	DLLA160S 684	0433 271 338				4x0,36x160°	Nozzle
<b>71171C</b>	DLLA151S 686	0433 271 894				4x0,26x151°	Nozzle
<b>711721C</b>	DLLA150S 690	0433 271 891				4x0,29x150°	Nozzle
<b>711725C</b>	DLLA155S 695	0433 271 890				4x0,41x155°	Nozzle
<b>711725L</b>	DLLA160S 699	0433 271 343				4x0,38x160°	Nozzle
<b>711726C</b>	DLLA152S 703	0433 271 886				4x0,28x152°	Nozzle
<b>711731C</b>	DLLA150S 704	0433 271 885				5x0,30x150°	Nozzle
<b>711737L</b>	DLLA160S 707	0433 271 344				4x0,29x160°	Nozzle
<b>711742</b>	DLLA150S 709	0433 271 354				4x0,32x150°	Nozzle
<b>711743</b>	DLLA155S 710	0433 271 884				4x0,31x155°	Nozzle
<b>711747C</b>	DLLA155S 713	0433 271 883				4x0,33x155°	Nozzle
<b>711751</b>	DLLA150S 714	0433 271 348				4x0,34x150°	Nozzle
<b>711752L</b>	DLLA149S 715	0433 271 349				3x0,41x149°	Nozzle
<b>711753C</b>	DLLA150S 716	0433 271 882				4x0,27x150°	Nozzle
<b>711754</b>	DLLA150S 718	0433 271 353				4x0,41x150°	Nozzle
<b>71176</b>	DLLA150S 720	0433 271 036				4x0,29x150°	Nozzle
<b>71177</b>	DLLA25S 722	0433 271 355				1x0,66x25°	Nozzle
<b>711771</b>	DLLA155S 723	0433 271 352				4x0,30x155°	Nozzle
<b>711772</b>	DLLA150S 724	0433 271 356				4x0,37x150°	Nozzle
<b>711774</b>	DLLA165S 727	0433 271 358					Nozzle

<i>Our Ref.</i>	<i>Stamping</i>	<i>Part Number</i>	<i>CP</i>	<i>DLC</i>	<i>D/A</i>	<i>Technical Data</i>	<i>Description</i>
<b>711775C</b>	DLLA150S 728	0433 271 879				4x0,30x150°	Nozzle
<b>711776C</b>	DLLA155S 729	0433 271 878				5x0,26x155°	Nozzle
<b>71179</b>	DLLA155S 733	0433 271 359				4x0,36x155°	Nozzle
<b>711798C</b>	DLLA150S 739	0433 271 874				5x0,31x150°	Nozzle
<b>711801C</b>	DLLA150S 741	0433 271 873				4x0,31x150°	Nozzle
<b>71181</b>	DLLA24S 745	0433 271 363				1x0,53x24°	Nozzle
<b>71182</b>	DLLA144S 747	0433 271 366				4x0,38x144°	Nozzle
<b>71183</b>	DLLA34S 749	0433 271 365				1x0,70x34°	Nozzle
<b>71184C</b>	DLLA150S 753	0433 271 868				5x0,35x150°	Nozzle
<b>71185C</b>	DLLA150S 754	0433 271 867				5x0,27x150°	Nozzle
<b>711861C</b>	DLLA160S 760	0433 271 866				4x0,31x160°	Nozzle
<b>711862C</b>	DLLA150S 762	0433 271 865				4x0,41x150°	Nozzle
<b>711872C</b>	DLLA158S 766	0433 271 864				4x0,28x158°	Nozzle
<b>711881C</b>	DLLA150S 767	0433 271 863				6x0,32x150°	Nozzle
<b>711884</b>	DLLA145S 770	0433 271 375				4x0,32x145°	Nozzle
<b>71190</b>	DLLA150S 773	9430 084 204				4x0,31x150°	Nozzle
<b>71191</b>	DLLA149S 774	0433 271 376				4x0,30x149°	Nozzle
<b>71192</b>	DLLA149S 775	0433 271 377				4x0,32x149°	Nozzle
<b>711922</b>	DLLA150S 777	0433 271 379				4x0,41x150°	Nozzle
<b>71193</b>	DLLA150S 781	0433 271 394				4x0,41x150°	Nozzle
<b>711932C</b>	DLLA152S 783	0433 271 861				6x0,275x152°	Nozzle
<b>71194</b>	DLLA140S 786	0433 271 395				4x0,39x140°	Nozzle
<b>711942</b>	DLLA160S 787	0433 271 396				4x0,27x160°	Nozzle
<b>71195C</b>	DLLA150S 789	0433 271 859				4x0,37x150°	Nozzle
<b>71196</b>	DLLA142S 791	0433 271 403				4x0,31x142°	Nozzle
<b>71197</b>	DLLA142S 792	0433 271 404				4x0,33x142°	Nozzle
<b>711971</b>	DLLA150S 793	0433 271 398				4x0,43x150°	Nozzle
<b>711975C</b>	DLLA150S 798	0433 271 857				3x0,30x150°	Nozzle
<b>711981C</b>	DLLA150S 804	0433 271 856				4x0,31x150°	Nozzle
<b>711982CL</b>	DLLA150S 806	0433 271 855				4x0,30x150°	Nozzle
<b>71199</b>	DLLA144S 808	0433 271 410				4x0,33x144°	Nozzle
<b>711991</b>	DLLA35S 812	0433 271 413				1x0,51x35°	Nozzle
<b>71200C</b>	DLLA151S 813	0433 271 850				4x0,29x151°	Nozzle
<b>71201C</b>	DLLA150S 815	0433 271 849				4x0,30x150°	Nozzle
<b>712026C</b>	DLLA150S 816	0433 271 848				4x0,35x150°	Nozzle
<b>71202C</b>	DLLA160S 817	0433 271 847				4x0,32x160°	Nozzle
<b>71204C</b>	DLLA156S 822	0433 271 845				4x0,27x156°	Nozzle
<b>71205C</b>	DLLA140S 827	0433 271 843				4x0,31x140°	Nozzle
<b>71206C</b>	DLLA150S 828	0433 271 842				2x0,23+2x0,25	Nozzle
<b>71207</b>	DLLA144S 829	0433 271 423				4x0,41x144°	Nozzle
<b>712071C</b>	DLLA150S 830	0433 271 841				3x0,37x150°	Nozzle
<b>712073</b>	DLLA155S 833	9430 034 227				4x0,25x155°	Nozzle
<b>712079C</b>	DLLA155S 835	0433 271 839				4x0,36x155°	Nozzle
<b>71208C</b>	DLLA150S 836	0433 271 838				4x0,29x150°	Nozzle
<b>71209</b>	DLLA34S 837	0433 271 421				1x0,60x34°	Nozzle
<b>71209C</b>	DLLA150S 838	0433 271 837				5x0,37x150°	Nozzle
<b>71210C</b>	DLLA144S 842	0433 271 835				4x0,37x144°	Nozzle
<b>71211C</b>	DLLA150S 843	0433 271 834				4x0,32x150°	Nozzle
<b>71212</b>	DLLA145S 847	0433 271 424				4x0,34x145°	Nozzle
<b>71212C</b>	DLLA150S 851/	0433 271 730				5x0,32x150°	Nozzle
<b>71213</b>	DLLA150S 852	0433 271 425				4x0,32x150°	Nozzle
<b>712131C</b>	DLLA150S 853	0433 271 829				5x0,37x150°	Nozzle
<b>712132C</b>	DLLA155S 858	0433 271 825				4x0,39x155°	Nozzle
<b>712134</b>	DLLA148S 862	0433 271 428				4x0,30x148°	Nozzle

<i>Our Ref.</i>	<i>Stamping</i>	<i>Part Number</i>	<i>CP</i>	<i>DLC</i>	<i>D/A</i>	<i>Technical Data</i>	<i>Description</i>
<b>712135C</b>	DLLA150S 870	0433 271 823				4x0,34x150°	Nozzle
<b>712142</b>	DLLA150S 873	0433 271 434				4x0,32x150°	Nozzle
<b>712145</b>	DLLA34S 876	0433 271 435				1x0,71x34°	Nozzle
<b>712146C</b>	DLLA150S 881	0433 271 821				4x0,36x150°	Nozzle
<b>712147C</b>	DLLA150S 883	0433 271 820				5x0,39x150°	Nozzle
<b>712152CL</b>	DLLA148S 885	0433 271 819				4x0,36x148°	Nozzle
<b>712153CL</b>	DLLA145S 886	0433 271 818				4x0,34x145°	Nozzle
<b>712154C</b>	DLLA144S 889	0433 271 817				4x0,30x144°	Nozzle
<b>712161C</b>	DLLA146S 890	0433 271 816				4x0,34x146°	Nozzle
<b>71217</b>	DLLA150S 891	0433 271 440				3x0,31x150°	Nozzle
<b>712171</b>	DLLA28S 892	0433 271 442				1x0,60x28°	Nozzle
<b>712171C</b>	DLLA155S 895	0433 271 815				6x0,29x155°	Nozzle
<b>71219C</b>	DLLA150S 896	0433 271 814				5x0,32x150°	Nozzle
<b>71300C</b>	DLLA142S 897	0433 271 813				4x0,30x142°	Nozzle
<b>71301C</b>	DLLA150S 898	9430 084 212				4x0,31x150°	Nozzle
<b>713021</b>	DLLA32S 900	0433 271 445				1x0,54x32°	Nozzle
<b>713023</b>	DLLA150S 902	0433 271 446				4x0,36x150°	Nozzle
<b>71303C</b>	DLLA150S 903	0433 271 811				4x0,30x150°	Nozzle
<b>713041C</b>	DLLA150S 904	0433 271 810				4x0,44x150°	Nozzle
<b>71305C</b>	DLLA160S 908	0433 271 809				4x0,30x160°	Nozzle
<b>713062</b>	DLLA148S 909	0433 271 448				4x0,32x148°	Nozzle
<b>713064</b>	DLLA156S 911	0433 271 450				5X0,23x153°	Nozzle
<b>713071</b>	DLLA31S 915	0433 271 452				1x0,68x31°	Nozzle
<b>713071C</b>	DLLA150S 916	0433 271 807				5x0,34x150°	Nozzle
<b>713072C</b>	DLLA158S 920	0433 271 806				4x0,28x158°	Nozzle
<b>713073</b>	DLLA31S 921	0433 271 454				1x0,56x31°	Nozzle
<b>713074C</b>	DLLA142S 924	0433 271 805				4x0,43x142°	Nozzle
<b>713075C</b>	DLLA150S 925	0433 271 804				4x0,28x150°	Nozzle
<b>713076</b>	DLLA142S 926	0433 271 466				4x0,35x142°	Nozzle
<b>713079</b>	DLLA30S 931	0433 271 461				1x0,62x30°	Nozzle
<b>713080</b>	DLLA150S 935	0433 271 462				4x0,39x150°	Nozzle
<b>713081C</b>	DLLA136S 943	0433 271 740				4x0,41x136°	Nozzle
<b>713082C</b>	DLLA142S 947	0433 271 800				4x0,37x142°	Nozzle
<b>713083</b>	DLLA142S 953	9430 084 222				4x0,35x142°	Nozzle
<b>713083C</b>	DLLA154S 970	0433 271 791				4x0,38x154°	Nozzle
<b>713084C</b>	DLLA151S 972	0433 271 790				4x0,33x151°	Nozzle
<b>713085C</b>	DLLA150S 974	0433 271 789				4x0,285x150°	Nozzle
<b>71309</b>	DLLA150S 975	0433 271 465				4x0,42x150°	Nozzle
<b>71310C</b>	DLLA140S 976	0433 271 788				4x0,46x140°	Nozzle
<b>713112C</b>	DLLA150S 977	0433 271 787				4x0,28x150°	Nozzle
<b>713117C</b>	DLLA142S 980	0433 271 785				4x0,32x142°	Nozzle
<b>713118C</b>	DLLA132S 981	0433 271 784				4x0,34x132°	Nozzle
<b>713119</b>	DLLA144S 982	0433 271 467				4x0,30x144°	Nozzle
<b>71312C</b>	DLLA138S 983	0433 271 783				4x0,35x138°	Nozzle
<b>71313C</b>	DLLA151S 985	0433 271 782				4x0,30x151°	Nozzle
<b>713151</b>	DLLA151S 991	9430 084 226				4x0,27x151°	Nozzle
<b>71316C</b>	DLLA144S 992	0433 271 781				5x0,35x144°	Nozzle
<b>71317C</b>	DLLA150S 993	0433 271 780				4x0,24x150°	Nozzle
<b>71317CL</b>	DLLA160S 995	0433 271 778				4x0,29x160°	Nozzle
<b>71318</b>	DLLA134S 999	0433 271 471				4x0,38x134°	Nozzle
<b>71318C</b>	DLLA134S999 D5	0433 271 471				4x0,38x134°	Nozzle
<b>71319</b>	DLLA134S 999+/ D5	0433 271 589				4x0,38x134°	Nozzle
<b>71320C</b>	DLLA136S 1000	0433 271 775				3x0,36x136°	Nozzle
<b>71321C</b>	DLLA124S 1001	0433 271 774				4x0,31x124°	Nozzle

<i>Our Ref.</i>	<i>Stamping</i>	<i>Part Number</i>	<i>CP</i>	<i>DLC</i>	<i>D/A</i>	<i>Technical Data</i>	<i>Description</i>
<b>71323</b>	DLLA140S 1003	0433 271 478				4x0,35x140°	Nozzle
<b>713242C</b>	DLLA160S 1012	0433 271 770				4x0,27x160°	Nozzle
<b>713243</b>	DLLA142S 1013	9430 084 227				4x0,33x142°	Nozzle
<b>713245L</b>	DLLA140S 1017	0433 271 480				3x0,45x140°	Nozzle
<b>713246</b>	DLLA145S 1018	0433 271 481				8x0,25x145°	Nozzle
<b>713247</b>	DLLA145S 1019	0433 271 482				8x0,28x145°	Nozzle
<b>71325C</b>	DLLA136S 1020	0433 271 768				3x0,39x136°	Nozzle
<b>71327CL</b>	DLLA145S 1023	0433 271 765				4x0,33x145°	Nozzle
<b>71329C</b>	DLLA150S 1029	0433 271 764				5x0,27x150°	Nozzle
<b>71330C</b>	DLLA160S 1030	0433 271 763				4x0,26x160°	Nozzle
<b>71331C</b>	DLLA155S 1032	0433 271 761				5x0,23x155°	Nozzle
<b>71332</b>	DLLA136S 1034	0433 271 487				4x0,36x136°	Nozzle
<b>713321</b>	DLLA131S 1035	0433 271 486				4x0,39x131°	Nozzle
<b>71333</b>	DLLA144S 1037	0433 271 489				4x0,37x144°	Nozzle
<b>713341C</b>	DLLA140S 1039	0433 271 759				4x0,32x140°	Nozzle
<b>713343</b>	DLLA136S 1043	0433 271 495				4x0,38x136°	Nozzle
<b>713344C</b>	DLLA150S 1044	0433 271 758				5x0,35x150°	Nozzle
<b>71335</b>	DLLA150S 1052	0433 271 494				4x0,28x150°	Nozzle
<b>713351C</b>	DLLA140S 1054	0433 271 756				5x0,41x140°	Nozzle
<b>713353C</b>	DLLA150S 1055	0433 271 755				4x0,32x150°	Nozzle
<b>713356C</b>	DLLA148S 1058	0433 271 754				4x0,37x148°	Nozzle
<b>713357C</b>	DLLA145S 1059	0433 271 753				5x0,36x145°	Nozzle
<b>71336C</b>	DLLA150S 1066	0433 271 746				3x0,34x150°	Nozzle
<b>71337C</b>	DLLA150S 1067	0433 271 745				4x0,28x150°	Nozzle
<b>713380C</b>	DLLA140S 1075	0433 271 741				4x0,47x140°	Nozzle
<b>713382C</b>	DLLA159S 1082	0433 271 738				4x0,25x159°	Nozzle
<b>713384C</b>	DLLA160S 1084	0433 271 736				4x0,27x160°	Nozzle
<b>713386C</b>	DLLA154S 1086	0433 271 735				5x0,35x154°	Nozzle
<b>7133872C</b>	DLLA150S 1087	0433 271 734				4x0,32x150°	Nozzle
<b>7133874C</b>	DLLA148S 1089	0433 271 732				5x0,30x145°	Nozzle
<b>713387C</b>	DLLA150S 1091	0433 271 731				5x0,27x150°	Nozzle
<b>71339</b>	DLLA136S 1094	0433 271 499				4x0,37x136°	Nozzle
<b>71340</b>	DLLA142S 1096	0433 271 502				4x0,31x142°	Nozzle
<b>71341C</b>	DLLA145S 1097	0433 271 729				5x0,34x145°	Nozzle
<b>71342C</b>	DLLA148S 1098	0433 271 728				4x0,30x148°	Nozzle
<b>71343C</b>	DLLA140S 1109	0433 271 722				4x0,33x140°	Nozzle
<b>713442C</b>	DLLA138S 1112	0433 271 720				3x0,34x138°	Nozzle
<b>713443C</b>	DLLA134S 1113	0433 271 719				4x0,30x134°	Nozzle
<b>71345C</b>	DLLA140S 1116	0433 271 718				5x0,36x140°	Nozzle
<b>713461C</b>	DLLA140S 1117	0433 271 717				5x0,36x140°	Nozzle
<b>713462</b>	DLLA134S 1119	0433 271 503				4x0,37x134°	Nozzle
<b>713463C</b>	DLLA140S 1121	0433 271 716				4x0,31x140°	Nozzle
<b>713467</b>	DLLA131S 1131	0433 271 507				4x0,41x131°	Nozzle
<b>71347C</b>	DLLA150S 1137	0433 271 714				8x0,33x150°	Nozzle
<b>713482</b>	DLLA142S 1142	9430 034 284				4x0,28x142°	Nozzle
<b>71350</b>	DLLA137S 1157	0433 271 515				5x0,30x137°	Nozzle
<b>71350C</b>	DLLA150S 1158	0433 271 704				4x0,30x150°	Nozzle
<b>713522C</b>	DLLA145S 1160	0433 271 703				5x0,39x145°	Nozzle
<b>713523C</b>	DLLA145S 1161	0433 271 702				5x0,36x145°	Nozzle
<b>713524C</b>	DLLA144S 1162	9430 084 241				4x0,30x144°	Nozzle
<b>71353C</b>	DLLA145S 1169	0433 271 698				6x0,32x145°	Nozzle
<b>713543</b>	DLLA142S 1173	0433 271 518				5x0,29x142°	Nozzle
<b>713544C</b>	DLLA137S 1174	0433 271 695				5x0,26x137°	Nozzle
<b>713545C</b>	DLLA146S 1175	0433 271 694				4x0,33x146°	Nozzle

<i>Our Ref.</i>	<i>Stamping</i>	<i>Part Number</i>	<i>CP</i>	<i>DLC</i>	<i>D/A</i>	<i>Technical Data</i>	<i>Description</i>
<b>713549C</b>	DLLA152S 1180	0433 271 691				5x0,28x152°	Nozzle
<b>713550C</b>	DLLA160S 1181	0433 271 690				4x0,24x160°	Nozzle
<b>713552C</b>	DLLA152S 1184	0433 271 688				5x0,26x152°	Nozzle
<b>713553C</b>	DLLA142S 1189	0433 271 684				4x0,34x142°	Nozzle
<b>713554</b>	DLLA35S 1190	0433 271 520				1x0,50x35°	Nozzle
<b>713555</b>	DLLA138S 1191	0433 271 521				5x0,32x138°	Nozzle
<b>713556</b>	DLLA138S 1191+/ 713557	0433 271 587				5x0,31x138°	Nozzle
<b>713557</b>	DLLA134S 1199	0433 271 524				5x0,33x134°	Nozzle
<b>7135572</b>	DLLA134S 1199+/ 71356	0433 271 588				5x0,33x134°	Nozzle
<b>71356</b>	DLLA151S 1200	9430 084 243				4x0,28x151°	Nozzle
<b>713561C</b>	DLLA134S 1201	0433 271 680				4x0,30x134°	Nozzle
<b>713563C</b>	DLLA148S 1204	0433 271 678				7x0,30x148°	Nozzle
<b>7135640C</b>	DLLA145S 1206	0433 271 676				5x0,35x145°	Nozzle
<b>7135641C</b>	DLLA149S 1207	0433 271 675				5x0,32x149°	Nozzle
<b>713564C</b>	DLLA137S 1208	0433 271 674				5x0,28x137°	Nozzle
<b>7135651C</b>	DLLA149S 1209	0433 271 673				5x0,36x149°	Nozzle
<b>7135654C</b>	DLLA155S 1215	0433 271 670				5x0,34x155°	Nozzle
<b>713565C</b>	DLLA140S 1217	0433 271 668				6x0,27x140°	Nozzle
<b>7135661C</b>	DLLA150S 1220	0433 271 666				6x0,31x150°	Nozzle
<b>713566C</b>	DLLA155S 1221	0433 271 665				6x0,30x155°	Nozzle
<b>713567</b>	DLLA142S 1224	0433 271 527				6x0,29x142°	Nozzle
<b>7135672C</b>	DLLA149S 1225	0433 271 664				5x0,31x149°	Nozzle
<b>7135675L</b>	DLLA139S 1235	0433 271 529				4x0,43x139°	Nozzle
<b>713568C</b>	DLLA150S 1237	0433 271 656				6x0,32x150°	Nozzle
<b>713569C</b>	DLLA150S 1238	0433 271 655				6x0,32x150°	Nozzle
<b>71357C</b>	DLLA146S 1245	0433 271 652				6x0,32x146°	Nozzle
<b>71358C</b>	DLLA140S 1252	0433 271 646				6x0,33x140°	Nozzle
<b>71359C</b>	DLLA130S 1253	9430 084 244				5x0,36x130°	Nozzle
<b>713602</b>	DLLA142S 1257	0433 271 534				5x0,30x142°	Nozzle
<b>71360C</b>	DLLA144S 1262	0433 271 645				4x0,32x144°	Nozzle
<b>71361C</b>	DLLA148S 1263	0433 271 644				7x0,29x148°	Nozzle
<b>71362</b>	DLLA142S 1264	9430 084 245				4x0,32x142°	Nozzle
<b>71364</b>	DLLA142S 1266	9430 084 247				4x0,34x142°	Nozzle
<b>713642C</b>	DLLA148S 1272	0433 271 638				7x0,29x148°	Nozzle
<b>7136433C</b>	DLLA137S 1273	9430 034 719				5x0,28x137°	Nozzle
<b>7136439C</b>	DLLA152S 1277	0433 271 635				8x0,25x152°	Nozzle
<b>713644C</b>	DLLA125S 1278	0433 271 634				6x0,28x125°	Nozzle
<b>713645C</b>	DLLA152S 1280	0433 271 632				8x0,26x152°	Nozzle
<b>713646</b>	DLLA134S 1284+/ 713646C	0433 271 590				5x0,34x134°	Nozzle
<b>713646C</b>	DLLA143S 1292	0433 271 626				6x0,33x143°	Nozzle
<b>713648C</b>	DLLA150S 1295	0433 271 625				6x0,31x150°	Nozzle
<b>713650C</b>	DLLA148S 1298	0433 271 624				7x0,34x148°	Nozzle
<b>713654C</b>	DLLA143S 1302	0433 271 616				6x0,31x143°	Nozzle
<b>7136558C</b>	DLLA155S 1308	0433 271 603				7x0,31x156°	Nozzle
<b>7136559C</b>	DLLA135S 1309	0433 271 602				6x0,26x135°	Nozzle
<b>713655C</b>	DLLA160S 1305	0433 271 614				5x0,33x160°	Nozzle
<b>7136560C</b>	DLLA146S 1310	0433 271 601				7x0,29x146°	Nozzle
<b>7136561C</b>	DLLA132S 1320	0433 272 997				5x0,23x132°	Nozzle
<b>7136562C</b>	DLLA150S 1322	0433 272 995				4x0,33x150°	Nozzle
<b>7136565</b>	DLLA145S 1330	0433 272 004				8x0,28x145°	Nozzle
<b>713656C</b>	DLLA155S 1323	0433 272 994				4x0,30x155°	Nozzle
<b>7136574C</b>	DLLA150S 1339	F002 C30 007				4x0,29x150°	Nozzle
<b>7136575C</b>	DLLA155S 1351	0433 272 980				6x0,22+6x0,30	Nozzle
<b>713657C</b>	DLLA132S 1335	0433 272 987				5x0,20x132°	Nozzle

<i>Our Ref.</i>	<i>Stamping</i>	<i>Part Number</i>	<i>CP</i>	<i>DLC</i>	<i>D/A</i>	<i>Technical Data</i>	<i>Description</i>
<b>713658C</b>	DLLA132S 1384	0433 272 963				6x0,19x132°	Nozzle
<b>713659</b>	DLLA155S 1420	0433 272 045				8x0,27x155°	Nozzle
<b>71366</b>	DLLA150S 1600	0433 271 040				5x0,25x150°	Nozzle
<b>71367</b>	DLLA150S 2120	0433 271 268				4x0,35x150°	Nozzle
<b>71368</b>	DLLA35S 2180	0433 271 078				1x0,70x35°	Nozzle
<b>71369</b>	DLLA144S 8200	0433 271 447				4x0,35x144°	Nozzle
<b>71404L</b>	DLLB160S 544	0433 271 255				4x0,28x160°	Nozzle
<b>714053</b>	DLLB155S 580	0433 271 278				5x0,31x155°	Nozzle
<b>714058</b>	DLLB155S 598	0433 271 291				4x0,41x155°	Nozzle
<b>714075</b>	DLLB155S 675	0433 271 332				4x0,38x155°	Nozzle
<b>714078</b>	DLLB150S 688	0433 271 340				4x0,36x150°	Nozzle
<b>71412</b>	DLLB150S 711	0433 271 346				4x0,38x150°	Nozzle
<b>71415</b>	DLLB150S 765	0433 271 347				4x0,37x150°	Nozzle
<b>714166</b>	DLLB150S 794	0433 271 400				4x0,29x150°	Nozzle
<b>714171C</b>	DLLB150S 821	0433 271 846				4x0,30x150°	Nozzle
<b>714178C</b>	DLLB151S 854	0433 271 828				4x0,34x151°	Nozzle
<b>71420C</b>	DLLB151S 907	9430 084 214				4x0,30x151°	Nozzle
<b>71430</b>	DLLB150S 1049	9430 084 230				4x0,33x150°	Nozzle
<b>71454</b>	DLLC150S 624	0433 271 999				4x0,44x150°	Nozzle
<b>71457</b>	DLLC150S 646	0433 271 316				8x0,24x150°	Nozzle
<b>71460</b>	DLLC150S 660	0433 271 323				8x0,25x150°	Nozzle
<b>71470</b>	DLLZ156S 948	0433 271 460				4x0,28+5x0.30	Nozzle
<b>71473</b>	DLLZ156S 1048	0433 271 492				4x0.23+5x0.27	Nozzle
<b>71474C</b>	DLLZ155S 1133	0433 271 715				7x0,39x155°	Nozzle
<b>71475C</b>	DLLZ152S 1229	0433 271 660				5x0,55x152°	Nozzle
<b>71479C</b>	DLLZ152S 1247	0433 271 650				5x0,58x152°	Nozzle
<b>71501</b>	DLLA150P 1	0433 171 001				4x0,24x150°	Nozzle
<b>71503</b>	DLLA150P 3	0433 171 003				3x0,30x150°	Nozzle
<b>71505</b>	DLLA155P 5	0433 171 006				5x0,34x155°	Nozzle
<b>71509</b>	DLLA160P 9	0433 171 010				5x0,33x160°	Nozzle
<b>71511</b>	DLLA150P 11	0433 171 012				4x0,21x150°	Nozzle
<b>71520</b>	DLLA150P 20	0433 171 021				4x0,36x150°	Nozzle
<b>71522</b>	DLLA150P 22	0433 171 023				4x0,33x150°	Nozzle
<b>71524</b>	DLLA150P 24	0433 171 025				4x0,31x150°	Nozzle
<b>71529</b>	DLLA150P 29	0433 171 030				5x0,30x150°	Nozzle
<b>71530</b>	DLLA150P 30	0433 171 031				4x0,29x150°	Nozzle
<b>71531</b>	DLLA150P 31	0433 171 032				5x0,37x150°	Nozzle
<b>71535</b>	DLLA160P 35	0433 171 036				5x0,32x160°	Nozzle
<b>71536</b>	DLLA150P 36	0433 171 037				4x0,39x150°	Nozzle
<b>71538</b>	DLLA148P 38	0433 171 039				4x0,30x148°	Nozzle
<b>71539</b>	DLLA150P 39	0433 171 040				4x0,37x150°	Nozzle
<b>71540</b>	DLLA143P 40	0433 171 041				4x0,36x143°	Nozzle
<b>71542</b>	DLLA150P 42	0433 171 042				4x0,30x150°	Nozzle
<b>71543</b>	DLLA150P 43	0433 171 043				4x0,42x150°	Nozzle
<b>71544</b>	DLLA140P 44	0433 171 044				4x0,30x140°	Nozzle
<b>71548</b>	DLLA150P 48	0433 171 048				5x0,28x150°	Nozzle
<b>71549</b>	DLLA150P 49	0433 171 049				5x0,32x150°	Nozzle
<b>71552</b>	DLLA150P 52	0433 171 052				4x0,39x150°	Nozzle
<b>71553</b>	DLLA150P 53	0433 171 053				4x0,30x150°	Nozzle
<b>71559</b>	DLLA150P 59	0433 171 059				4x0,38x150°	Nozzle
<b>71561</b>	DLLA150P 61	0433 171 061				4x0,28x150°	Nozzle
<b>71563</b>	DLLA160P 63	0433 171 063				5x0,34x160°	Nozzle
<b>71564</b>	DLLA150P 64	0433 171 064				4x0,38x150°	Nozzle
<b>71566</b>	DLLA155P 66	0433 171 066				4x0,30x155°	Nozzle

<i>Our Ref.</i>	<i>Stamping</i>	<i>Part Number</i>	<i>CP</i>	<i>DLC</i>	<i>D/A</i>	<i>Technical Data</i>	<i>Description</i>
<b>71567</b>	DLLA155P 67	0433 171 067				4x0,28x155°	Nozzle
<b>71569</b>	DLLA136P 69	0433 171 069				3x0,38x136°	Nozzle
<b>71571</b>	DLLA150P 71	0433 171 071				4x0,24x150°	Nozzle
<b>71574</b>	DLLA155P 74	0433 171 074				4x0,29x155°	Nozzle
<b>71576</b>	DLLA150P 76	0433 171 076				4x0,42x150°	Nozzle
<b>71585</b>	DLLA160P 85	0433 171 082				4x0,29x160°	Nozzle
<b>71587</b>	DLLA142P 87	0433 171 084				5x0,32x142°	Nozzle
<b>715908</b>	DLLA150P 91/	0433 171 117				5x0,38x150°	Nozzle
<b>71591</b>	DLLA150P 91/+	0433 171 164				5x0,37x150°	Nozzle
<b>71593</b>	DLLA143P 93	0433 171 089				5x0,30x143°	Nozzle
<b>71596</b>	DLLA143P 96	0433 171 092				4x0,33x143°	Nozzle
<b>71597</b>	DLLA148P 97	0433 171 093				4x0,32x148°	Nozzle
<b>71599</b>	DLLA150P 99	0433 171 095				5x0,34x150°	Nozzle
<b>715994</b>	DLLA153P 034M					5x0,27x153°	Nozzle
<b>715995</b>	DLLA153P 035M					5x0,25x153°	Nozzle
<b>71600</b>	DLLA150P 100	9430 084 702				5x0,28x150°	Nozzle
<b>71606</b>	DLLA150P 106	9430 084 703				5x0,29x150°	Nozzle
<b>71610</b>	DLLA150P 110	0433 171 100				4x0,37x150°	Nozzle
<b>71612</b>	DLLA150P 112	9430 084 708				4x0,36x150°	Nozzle
<b>71613</b>	DLLA150P 113	0433 171 102				4x0,30x150°	Nozzle
<b>71614</b>	DLLA155P 114	0433 171 103				4x0,32x155°	Nozzle
<b>71615</b>	DLLA150P 115	0433 171 104				4x0,32x150°	Nozzle
<b>71618</b>	DLLA144P 118	0433 171 107				4x0,32x144°	Nozzle
<b>71619</b>	DLLA150P 119	0433 171 108				5x0,40x150°	Nozzle
<b>71622</b>	DLLA143P 122	0433 171 111				4x0,34x143°	Nozzle
<b>71623</b>	DLLA143P 123	0433 171 112				4x0,38x143°	Nozzle
<b>71625</b>	DLLA155P 125	0433 171 113				4x0,29x155°	Nozzle
<b>716291</b>	DLLA150P 129/	9430 084 711				5x0,33x150°	Nozzle
<b>71630</b>	DLLA150P 130	0433 171 118				4x0,34x150°	Nozzle
<b>71631</b>	DLLA150P 131	0433 171 119				4x0,30x150°	Nozzle
<b>71633</b>	DLLA150P 133	0433 171 121				4x0,34x150°	Nozzle
<b>71635</b>	DLLA155P 135	0433 171 123				4x0,35x155°	Nozzle
<b>71639</b>	DLLA146P 139	0433 171 127				4x0,39x146°	Nozzle
<b>71640</b>	DLLA146P 140	0433 171 128				4x0,44x146°	Nozzle
<b>71644</b>	DLLA144P 144	0433 171 130				5x0,36x144°	Nozzle
<b>71645</b>	DLLA150P 145	0433 171 131				4x0,33x150°	Nozzle
<b>71649</b>	DLLA148P 149	0433 171 134				5x0,33x148°	Nozzle
<b>71653</b>	DLLA155P 153	9430 084 714				4x0,29x155°	Nozzle
<b>716542</b>	DLLA146P 154-	0433 171 165				5x0,38x146°	Nozzle
<b>71655</b>	DLLA150P 155	9430 084 715				4x0,36x150°	Nozzle
<b>71657</b>	DLLA155P 157	0433 171 140				4x0,31x155°	Nozzle
<b>71660</b>	DLLA143P 160	0433 171 143				4x0,34x143°	Nozzle
<b>71661</b>	DLLA158P 161	0433 171 144				7x0,24x158°	Nozzle
<b>71663</b>	DLLA148P 163	0433 171 146				4x0,32x148°	Nozzle
<b>71664</b>	DLLA148P 164	0433 171 147				4x0,31x148°	Nozzle
<b>71666</b>	DLLA146P 166	0433 171 149				4x0,41x146°	Nozzle
<b>716662</b>	DLLA146P 166/	0433 171 214				4x0,40x146°	Nozzle
<b>71667</b>	DLLA150P 167	0433 171 150				5x0,295x150°	Nozzle
<b>71668</b>	DLLA158P 168	0433 171 151				7x0,26x158°	Nozzle
<b>71671</b>	DLLA160P 171	0433 171 153				5x0,29x160°	Nozzle
<b>716741</b>	DLLA150P 174/	9430 084 717				5x0,28x150°	Nozzle
<b>71675</b>	DLLA140P 175	0433 171 154				4x0,29x140°	Nozzle
<b>71677</b>	DLLA150P 177	0433 171 156				5x0,36x150°	Nozzle
<b>71678</b>	DLLA150P 178	0433 171 157				5x0,32x150°	Nozzle

<i>Our Ref.</i>	<i>Stamping</i>	<i>Part Number</i>	<i>CP</i>	<i>DLC</i>	<i>D/A</i>	<i>Technical Data</i>	<i>Description</i>
<b>71679</b>	DLLA155P 179	0433 171 158				6x0,24x155°	Nozzle
<b>716791</b>	DLLA155P 179	F019 121 179				7x0,235x155°	Nozzle
<b>71680</b>	DLLA134P 180	0433 171 159				4x0,29x134°	Nozzle
<b>716801</b>	DLLA155P 180	F019 121 180				7x0,245x155°	Nozzle
<b>71683</b>	DLLA150P 183	9430 084 718				5x0,30x150°	Nozzle
<b>71684</b>	DLLA144P 184	0433 171 161				4x0,39x144°	Nozzle
<b>716842</b>	DLLA144P 184/	0433 171 174				4x0,40x144°	Nozzle
<b>71686</b>	DLLA134P 186	0433 171 162				5x0,37x134°	Nozzle
<b>71690</b>	DLLA146P 190	0433 171 163				5x0,355x146°	Nozzle
<b>71699</b>	DLLA150P 199	0433 171 168				5x0,35x150°	Nozzle
<b>71703</b>	DLLA146P 203	0433 171 169				5x0,40x146°	Nozzle
<b>71705</b>	DLLA150P 205	0433 171 171				4x0,30x150°	Nozzle
<b>71706</b>	DLLA154P 206	0433 171 172				4x0,25x154°	Nozzle
<b>71709</b>	DLLA160P 209	0433 171 173				3+3x0,27x160°	Nozzle
<b>71712</b>	DLLA150P 212	9430 394 401				4x0,24x150°	Nozzle
<b>71717</b>	DLLA155P 217	F019 121 217				7x0,245x155°	Nozzle
<b>71721</b>	DLLA142P 221	0433 171 180				5x0,32x142°	Nozzle
<b>71724</b>	DLLA146P 224	0433 171 182				5x0,32x146°	Nozzle
<b>71728</b>	DLLA150P 228	0433 171 186				4x0,28x150°	Nozzle
<b>71729</b>	DLLA148P 229	0433 171 187				6x0,24x148°	Nozzle
<b>71730</b>	DLLA155P 230	0433 171 188	CP			8x0,26x155°	Nozzle
<b>71732</b>	DLLA150P 232	0433 171 190				4x0,30x150°	Nozzle
<b>71735</b>	DLLA150P 235	0433 171 193				5x0,28x150°	Nozzle
<b>71741</b>	DLLA148P 241	0433 171 195				5x0,32x148°	Nozzle
<b>71750</b>	DLLA135P 250	0433 171 200				5x0,30x135°	Nozzle
<b>71770</b>	DLLA155P 270	0433 171 204				5x0,29x155°	Nozzle
<b>71771</b>	DLLA140P 271	9430 084 731				6x0,21x140°	Nozzle
<b>71773</b>	DLLA155P 273	0433 171 205				4x0,28x155°	Nozzle
<b>71774</b>	DLLA155P 274	0433 171 206				4x0,31x155°	Nozzle
<b>71777</b>	DLLA155P 277	0433 171 208				4x0,34x155°	Nozzle
<b>71782</b>	DLLA155P 282	9430 084 734				5x0,33x155°	Nozzle
<b>71785</b>	DLLA152P 285	0433 171 210				6x0,28x152°	Nozzle
<b>71786</b>	DLLA145P 286	0433 171 211				6x0,23x145°	Nozzle
<b>71796</b>	DLLA134P 296	0433 171 215				6x0,26x134°	Nozzle
<b>71799</b>	DLLA150P 299	0433 171 216				4x0,29x150°	Nozzle
<b>71805</b>	DLLA140P 305	0433 171 220				4x0,35x140°	Nozzle
<b>71806</b>	DLLA155P 306	0433 171 221	CP			8x0,24x155°	Nozzle
<b>71807</b>	DLLA155P 307	0433 171 222				8x0,26x155°	Nozzle
<b>71809</b>	DLLA145P 309	9430 084 732				5x0,27x145°	Nozzle
<b>71810</b>	DLLA145P 310	9430 084 733				5x0,27x145°	Nozzle
<b>71812</b>	DLLA142P 312	0433 171 223				5x0,35x142°	Nozzle
<b>71813</b>	DLLA152P 313	0433 171 224				6x0,26x152°	Nozzle
<b>71815</b>	DLLA150P 315	0433 171 225				5x0,26x150°	Nozzle
<b>71816</b>	DLLA154P 316	0433 171 226				4x0,25x154°	Nozzle
<b>71823</b>	DLLA140P 323	9430 084 740					Nozzle
<b>71826</b>	DLLA150P 326	0433 171 231				5x0,27x150°	Nozzle
<b>71828</b>	DLLA145P 328	0433 171 232				6x0,23x145°	Nozzle
<b>71829</b>	DLLA148P 329	0433 171 233				7x0,25x148°	Nozzle
<b>71832</b>	DLLA154P 332	9430 084 742				5x0,28x154°	Nozzle
<b>71833</b>	DLLA155P 332					8x0,25x155°	Nozzle
<b>71834</b>	DLLA155P 334					8x0,27x155°	Nozzle
<b>71835</b>	DLLA152P 335	0433 171 237				6x0,27x152°	Nozzle
<b>71839</b>	DLLA152P 339	0433 171 241				6x0,29x152°	Nozzle
<b>71845</b>	DLLA150P 345	0433 171 246				4x0,28x150°	Nozzle

Our Ref.	Stamping	Part Number	CP	DLC	D/A	Technical Data	Description
<b>71853</b>	DLLA144P 353	0433 171 252				5x0,23x144°	Nozzle
<b>71854</b>	DLLA144P 354	0433 171 251				5x0,23x144°	Nozzle
<b>71855</b>	DLLA153P 355	0433 171 253				5x0,33x153°	Nozzle
<b>71860</b>	DLLA147P 360	0433 171 257				5x0,22x147°	Nozzle
<b>71869</b>	DLLA149P 369	0433 171 262				5x0,32x149°	Nozzle
<b>71870</b>	DLLA147P 370	0433 171 263				5x0,22x147°	Nozzle
<b>71871</b>	DLLA134P 371	0433 171 264				6x0,28x134°	Nozzle
<b>71872</b>	DLLA134P 372	0433 171 265				6x0,25x134°	Nozzle
<b>71873</b>	DLLA135P 373	0433 171 266				5x0,27x135°	Nozzle
<b>71874</b>	DLLA152P 378	0433 171 268				5x0,27x152°	Nozzle
<b>71875</b>	DLLA145P 392	0433 171 280				5x0,33x145°	Nozzle
<b>718754</b>	DLLA145P 394	0433 171 281				5x0,26x145°	Nozzle
<b>718758</b>	DLLA138P 401	0433 171 285				5x0,28x138°	Nozzle
<b>71876</b>	DLLA138P 403	0433 171 287				5x0,33x138°	Nozzle
<b>718761</b>	DLLA142P 406	0433 171 289				6x0,26x142°	2 Springs Nozzle
<b>718762</b>	DLLA148P 408	0433 171 291				7x0,24x148°	Nozzle
<b>7187623</b>	DLLA140P 411	0433 171 294				5x0,265x140°	Nozzle
<b>718763</b>	DLLA142P 418	0433 171 298				6x0,25x142°	Nozzle
<b>7187631</b>	DLLA142P 419	0433 171 299				6x0,24x142°	Nozzle
<b>718764</b>	DLLA134P 422	0433 171 303				5x0,28x134°	Nozzle
<b>718766</b>	DLLA134P 423	0433 171 304	CP			6x0,19x134°	Nozzle
<b>71877</b>	DLLA134P 424	0433 171 305	CP			6x0,185x134°	Nozzle
<b>718773</b>	DLLA168P 426	0433 171 306				8x0,24x168°	Nozzle
<b>71878</b>	DLLA134P 430	0433 171 309				5x0,28x134°	Nozzle
<b>718782</b>	DLLA134P 431	0433 171 310				5x0,255x134°	Nozzle
<b>718786</b>	DLLA145P 438	0433 171 316				6x0,215x145°	Nozzle
<b>71879</b>	DLLA144P 449	0433 171 323				4x0,33x144°	Nozzle
<b>71880</b>	DLLA144P 450	0433 171 324				4x0,36x144°	Nozzle
<b>71882</b>	DLLA152P 452	0433 171 326				8x0,28x152°	Nozzle
<b>718820</b>	DLLA158P 456/	0433 171 329				6x0,25x158°	Nozzle
<b>7188205</b>	DLLA149P 460	0433 171 333				5x0,23x149°	Nozzle
<b>718821</b>	DLLA145P 466	0433 171 335				6x0,21x145°	Nozzle
<b>718822</b>	DLLA160P 469	0433 171 338				4x0,21x160°	Nozzle
<b>7188222</b>	DLLA143P 471	0433 171 340				5x0,26x143°	Nozzle
<b>7188223</b>	DLLA160P 473	0433 171 341				6x0,32x158°	Nozzle
<b>7188224</b>	DLLA150P 476+	0433 171 343				6x0,23x150°	Nozzle
<b>7188225</b>	DLLA142P 479	0433 171 345				6x0,225x142°	Nozzle
<b>7188226</b>	DLLA152P 486/	0433 171 350				6x0,34x152°	Nozzle
<b>718823</b>	DLLA143P 495	0433 171 357				4x0,36x143°	Nozzle
<b>7188236</b>	DLLA152P 496	0433 171 358				8x0,25x152°	Nozzle
<b>718824</b>	DLLA146P 499	0433 171 360				5x0,34x146°	Nozzle
<b>7188242</b>	DLLA148P 500	0433 171 361				6x0,21x148°	Nozzle
<b>718825</b>	DLLA145P 504	0433 171 363				6x0,22x145°	Nozzle
<b>7188250</b>	DLLA144P 510	0433 171 366				5x0,27x144	Nozzle
<b>71882502</b>	DLLA148P 513	0433 171 369				6x0,26x148°	Nozzle
<b>71882503</b>	DLLA149P 514	0433 171 370				6x0,225x149°	Nozzle
<b>71882505</b>	DLLA148P 522	0433 171 386				7x0,24x148°	Nozzle
<b>71882506</b>	DLLA144P 521	0433 171 385				5x0,23x144°	Nozzle
<b>71882507</b>	DLLA150P 524	0433 171 387				5x0,23x144°	Nozzle
<b>7188251</b>	DLLA144P 527	0433 171 390				5x0,21x144°	Nozzle
<b>718826</b>	DLLA149P 528	0433 171 391				6x0,24x149°	Nozzle
<b>718827</b>	DLLA135P 530	0433 171 393	CP			5x0,30x135°	Nozzle
<b>718828</b>	DLLA152P 531	0433 171 394				7x0,27x152°	Nozzle
<b>71883</b>	DLLA147P 538	0433 171 398	CP			8x0,22x147°	Nozzle

Our Ref.	Stamping	Part Number	CP	DLC	D/A	Technical Data	Description
<b>718833</b>	DLLA149P 541	0433 171 400					Nozzle
<b>718835</b>	DLLA150P 545/	0433 171 403				8x0,31x150°	Nozzle
<b>71885</b>	DLLA137P 553	9430 084 749				5x0,26x137°	Nozzle
<b>718852</b>	DLLA150P 555	0433 171 407				6x0,23x150°	Nozzle
<b>718853</b>	DLLA155P 556	0433 171 408				7x0,235x155°	Nozzle
<b>71886</b>	DLLA155P 564	0433 171 413				5x0,30x155°	Nozzle
<b>718862</b>	DLLA152P 566	0433 171 414				8x0,25x152°	Nozzle
<b>718866</b>	DLLA155P 570	0433 171 431				5x0,31x155°	Nozzle
<b>718868</b>	DLLA152P 571	0433 171 432				6x0,245x152°	Nozzle
<b>71887</b>	DLLA155P 572/	0433 171 433	CP			8x0,20x155°	UIS Nozzle
<b>718872</b>	DLLA155P 572/+		CP			8x0,19x155°	UIS Nozzle
<b>718873</b>	DLLA150P 573	0433 171 434	CP			8x0,22x150°	Nozzle
<b>718874</b>	DLLA145P 574	0433 171 435				5x0,26x145°	Nozzle
<b>71888</b>	DLLA160P 577	0433 171 436	CP			8x0,20x160°	Nozzle
<b>718881</b>	DLLA155P 579+	0433 171 438				8x0,25x155°	Nozzle
<b>718882</b>	DLLA145P 580/	0433 171 439				6x0,24x145°	UIS Nozzle
<b>718883</b>	DLLA146P 581	0433 171 440				6x0,30x146°	Nozzle
<b>718885</b>	DLLA150P 585	0433 171 444				5x0,28x150°	Nozzle
<b>718888</b>	DLLA145P 593	0433 171 448	CP			8x0,21x145°	2 Springs Nozzle
<b>718892</b>	DLLA154P 596++	0433 171 450	CP			8x0,20x154°	Nozzle
<b>71890</b>	DLLA146P 600	9430 084 757				6x0,32x146°	Nozzle
<b>718901</b>	DLLA149P 601	0433 171 451	CP			8x0,23x149°	2 Springs Nozzle
<b>7189023</b>	DLLA145P 605	0433 171 453				5x0,24x145°	Nozzle
<b>7189024</b>	DLLA145P 606	0433 171 454				5x0,27x145°	Nozzle
<b>7189027</b>	DLLA145P 609	0433 171 456	CP			8x0,19x145°	2 Springs Nozzle
<b>718903</b>	DLLA148P 610	0433 171 457				7x0,25x148°	Nozzle
<b>7189031</b>	DLLA148P 611	0433 171 458				7x0,225x148°	Nozzle
<b>7189034</b>	DLLA155P 614	0433 171 461				5x0,295x155°	Nozzle
<b>718904</b>	DLLA145P 618	9430 084 759				5x0,26x145°	Nozzle
<b>718905</b>	DLLA145P 627	0433 171 466	CP			8x0,185x145°	2 Springs Nozzle
<b>718906</b>	DLLA140P 629	0433 171 467				5x0,28x140°	Nozzle
<b>7189062</b>	DLLA145P 632	0433 171 468				6x0,245x145°	Nozzle
<b>718907</b>	DLLA160P 634	0433 171 469	CP			4x0,165x160°	Nozzle
<b>71891</b>	DLLA150P 635	0433 171 470	CP			8x0,20x150°	UIS Nozzle
<b>718914</b>	DLLA159P 638	0433 171 473	CP			8x0,16x159°	2 Springs Nozzle
<b>71892</b>	DLLA155P 657	0433 171 465				8x0,24x155°	Nozzle
<b>718922</b>	DLLA147P 658	0433 171 478				5x0,25x147°	Nozzle
<b>718924</b>	DLLA152P 660	0433 171 480				5x0,30x152°	Nozzle
<b>718926</b>	DLLA144P 666	0433 171 485				6x0,20x144°	Nozzle
<b>718928</b>	DLLA158P 678	0433 171 493	CP			8x0,22x156°	Nozzle
<b>71893</b>	DLLA147P 680	0433 171 495				5x0,28x147°	Nozzle
<b>71894</b>	DLLA148P 694	0433 171 509				5x0,30x148°	Nozzle
<b>718942</b>	DLLA146P 708	0433 171 519				5x0,38x146°	Nozzle
<b>718943</b>	DLLA154P 709+	0433 171 520	CP			8x0,20x154°	Nozzle
<b>718945</b>	DLLA150P 711	0433 171 521				6x0,31x150°	Nozzle
<b>7189459</b>	DLLA158P 730	0433 171 530				6x0,245x157°	Nozzle
<b>718946</b>	DLLA142P 731	F000 430 300				5x0,35x142°	Nozzle
<b>718948</b>	DLLA145P 748	0433 171 536	CP			6x0,16x145°	2 Springs Nozzle
<b>718955</b>	DLLA155P 765	0433 171 545	CP			6x0,21x155°	UIS Nozzle
<b>718957</b>	DLLA145P 785/	0433 171 550				6x0,29x145°	Nozzle
<b>718958</b>	DLLA147P 799	0433 171 555				8x0,25x147°	Nozzle
<b>718959</b>	DLLA153P 810	0433 171 557	CP			8x0,13x153°	Nozzle
<b>718961</b>	DLLA156P 819	0433 171 561	CP			8x0,16x156°	Nozzle
<b>718962</b>	DLLA155P 822	0433 171 562	CP	DLC		8x0,205x155°	CR Nozzle

Our Ref.	Stamping	Part Number	CP	DLC	D/A	Technical Data	Description
<b>718963</b>	DLLA140P 826	0433 171 564	CP			8x0,22x140°	UIS Nozzle
<b>718965</b>	DLLA148P 836	0433 171 570	CP			6x0,18x148°	Nozzle
<b>718966</b>	DLLA134P 846	0433 171 574				5x0,36x134°	Nozzle
<b>718967</b>	DLLA150P 847	0433 171 575	CP			8x0,21x150°	UIS Nozzle
<b>718968</b>	DLLA150P 848	0433 171 576	CP			8x0,20x150°	UIS Nozzle
<b>7189682</b>	DLLA156P 850	0433 171 578	CP			8x0,16x156°	Nozzle
<b>7189686</b>	DLLA147P 854	0433 171 579				5x0,27x147°	Nozzle
<b>7189688</b>	DLLA154P 866	0433 171 583	CP			7x0,25x154°	Nozzle
<b>718969</b>	DLLA155P 872	0433 171 584				6x0,23x155°	UIS Nozzle
<b>7189691</b>	DLLA155P 872+					6x0,265x155°	UIS Nozzle
<b>7189693</b>	DLLA147P 875	0433 171 585				5x0,245x147°	Nozzle
<b>7189697</b>	DLLA155P 885	0433 171 592				8x0,265x155°	Nozzle
<b>718970</b>	DLLA156P 889/	0433 171 594	CP	DLC		6x0,17x156°	CR Nozzle
<b>718971</b>	DLLA143P 894/	0433 171 596	CP			8x0,195x143°	UIS Nozzle
<b>718972</b>	DLLA152P 903	0433 171 600				5x0,24x152°	UIS Nozzle
<b>7189723</b>	DLLA147P 905					6x0,23x147°	Nozzle
<b>718973</b>	DLLA150P 913	0433 171 607				6x0,227x150°	Nozzle
<b>718975</b>	DLLA145P 926+		CP			5x0,175x145°	CR Nozzle
<b>718986</b>	DLLA151P 941	0433 171 624				6x0,235x151°	Nozzle
<b>718987</b>	DLLA150P 943+	0433 171 628				6x0,235x150°	Nozzle
<b>7189875</b>	DLLA147P 945	0433 171 630					Nozzle
<b>718988</b>	DLLA140P 947	0433 171 631	CP			8x0,225x140°	UIS Nozzle
<b>71900</b>	DLLA150P 957	0433 171 634	CP			8x0,195x150°	Nozzle
<b>719003</b>	DLLA156P 963+	0433 171 637	CP			8x0,17x156°	Nozzle
<b>7190035</b>	DLLA152P 967	0433 171 640	CP			7x0,225x152°	Nozzle
<b>7190036</b>	DLLA168P 1006	0433 171 650				8x0,26x168°	Nozzle
<b>71900365</b>	DLLA150P 1008	0433 171 651				7x0,21x150°	Nozzle
<b>7190037</b>	DLLA148P 1010	0433 171 653	CP			6x0,20x148°	Nozzle
<b>7190038</b>	DLLA150P 1011/	0433 171 654	CP			5x0,165x150°	CR Nozzle
<b>719004</b>	DLLA145P 1015	0433 171 658				7x0,28x145°	Nozzle
<b>719005</b>	DLLA160P 1032+	0433 171 676	CP			8x0,20x160°	Nozzle
<b>7190068</b>	DLLA147P 1048+	0433 171 679	CP			6x0,185x147°	Nozzle
<b>71900681</b>	DLLA147P 1049+	0433 171 680	CP			6x0,17x147°	Nozzle
<b>7190069</b>	DLLA144P 1050	0433 171 681	CP	DLC		6x0,18x144°	CR Nozzle
<b>719007</b>	DLLA140P 1051	0433 171 682	CP	DLC		6x0,16x140°	CR Nozzle
<b>719008</b>	DLLA150P 1053	0433 171 684	CP			7x0,19x150°	Nozzle
<b>719009</b>	DLLA150P 1054	0433 171 685	CP			7x0,19x150°	Nozzle
<b>7190093</b>	DLLA156P 1059	0433 171 688	CP			8x0,155x156°	Nozzle
<b>7190098</b>	DLLA160P 1063+	0433 171 690	CP			6x0,16x160°	CR Nozzle
<b>719010</b>	DLLA148P 1067	0433 171 693	CP			6x0,18x148°	CR Nozzle
<b>7190102</b>	DLLA143P 1069	0433 171 695					CR Nozzle
<b>719011</b>	DLLA150P 1076	0433 171 699	CP	DLC		8x0,205x150°	CR Nozzle
<b>7190119</b>	DLLA153P 1080	0433 171 702	CP			8x0,185x153°	Nozzle
<b>719012</b>	DLLA152P 1081	0433 171 703	CP			8x0,19x152°	Nozzle
<b>7190141</b>	DLLA156P 1107+	0433 171 712	CP	DLC		6x0,165x156°	CR Nozzle
<b>719016</b>	DLLA156P 1114	0433 171 719	CP			6x0,19x156°	CR Nozzle
<b>7190164</b>	DLLA150P 1120+	0433 171 724				6x0,24x150°	Nozzle
<b>7190165</b>	DLLA147P 1121+	0433 171 362				7x0,265x147°	Nozzle
<b>7190168</b>	DLLA140P 1144	0433 171 734				5x0,28x140°	Nozzle
<b>719017</b>	DLLA150P 1151	0433 171 736	CP			8x0,22x150°	Nozzle
<b>7190171</b>	DLLA150P 1151		CP	DLC			Nozzle
<b>7190177</b>	DLLA150P 1163+	0433 171 740	CP			6x0,24x150°	Nozzle
<b>7190178</b>	DLLA150P 1164+	0433 171 741	CP			6x0,235x150°	Nozzle
<b>719018</b>	DLLA151P 1169	0433 171 743	CP			6x0,21x151°	Nozzle

Our Ref.	Stamping	Part Number	CP	DLC	D/A	Technical Data	Description
<b>719019</b>	DLLA144P 1170	0433 171 744	CP			7x0,19x144°	Nozzle
<b>719020</b>	DLLA140P 1181	0433 171 748				5x0,27x140°	Nozzle
<b>7190205</b>	DLLA145P 1189	0433 171 751				6x0,30x142°	Nozzle
<b>719021</b>	DLLA150P 1197/	0433 171 755	CP	DLC		6x0,16x150°	CR Nozzle
<b>719023</b>	DLLA166P 1217	0433 171 767				8x0,24x166°	Nozzle
<b>719024</b>	DLLA148P 1221	0433 171 771	CP			6x0,15x148°	CR Nozzle
<b>7190244</b>	DLLA150P 1224	0433 171 774	CP			5x0,135x150°	Nozzle
<b>7190246</b>	DLLA158P 1226	0433 171 776				8x0,25x158°	Nozzle
<b>7190253</b>	DLLA147P 1229	0433 171 779				6x0,24x147°	Nozzle
<b>7190254</b>	DLLA147P 1230	0433 171 780	CP	DLC		7x0,205x147°	Nozzle
<b>719026</b>	DLLA153P 1246++	0433 171 788	CP	DLC		7x0,14x153°	CR Nozzle
<b>719028</b>	DLLA144P 1264+	0433 171 797				5x0,22x144°	Nozzle
<b>719029</b>	DLLA150P 1269	0433 171 799				8x0,25x150°	UIS Nozzle
<b>7190291</b>	DLLA153P 1270+	0433 171 800	CP	DLC		7x0,14x153°	CR Nozzle
<b>7190299</b>	DLLA150P 1285	0433 171 808				6x0,245x150°	Nozzle
<b>71903</b>	DLLA152P 1286	0433 171 809	CP			8x0,19x152°	Nozzle
<b>719032</b>	DLLA146P 1296+	0433 171 811	CP	DLC		5x0,19x146°	Nozzle
<b>719033</b>	DLLA146P 1297	0433 171 812				5x0,245x146°	Nozzle
<b>719035</b>	DLLA160P 1308	0433 171 817					CR Nozzle
<b>7190353</b>	DLLA148P 1312	0433 171 819	CP	DLC		6x0,19x158°	CR Nozzle
<b>7190354</b>	DLLA134P 1314	F000 430 309					Nozzle
<b>719036</b>	DLLA148P 1334	0433 171 828					CR Nozzle
<b>719038</b>	DLLA146P 1339++	0433 171 831	CP	DLC		6x0,25x146°	CR Nozzle
<b>7190386</b>	DLLA148P 1347	0433 171 838					CR Nozzle
<b>7190389</b>	DLLA150P 1351	0433 171 841	CP			5x0,185x150°	Nozzle
<b>719039</b>	DLLA150P 1352	0433 171 842	CP			5x0,20x150°	Nozzle
<b>7190394</b>	DLLA142P 1363	0433 171 846	CP			6x0,15x142°	CR Nozzle
<b>7190399</b>	DLLA156P 1367	0433 171 847	CP			6x0,16x156°	CR Nozzle
<b>71904</b>	DLLA156P 1368	0433 171 848	CP			6x0,19x156°	CR Nozzle
<b>719041</b>	DLLA156P 1368/		CP	DLC		6x0,175x156°	CR Nozzle
<b>719042</b>	DLLA150P 1373	0433 171 853	CP	DLC		6x0,125x150°	CR Nozzle
<b>719043</b>	DLLA140P 1377/	0433 171 855	CP	DLC		8x0,14x140°	CR Nozzle
<b>719044</b>	DLLA158P 1385	0433 171 860	CP	DLC		7x0,155x158°	CR Nozzle
<b>719048</b>	DLLA135P 1400	0433 171 867	CP			8x0,18x133°	Nozzle
<b>71905</b>	DLLA143P 1404	0433 171 870	CP	DLC		6x0,19x143°	CR Nozzle
<b>719050</b>	DLLA146P 1405/	0433 171 871	CP	DLC		9x0,16x146°	CR Nozzle
<b>7190505</b>	DLLA144P 1413	0433 171 875					Nozzle
<b>719051</b>	DLLA144P 1417	0433 171 878	CP	DLC		7x0,245x144°	CR Nozzle
<b>7190511</b>	DLLA154P 1418	0433 171 879	CP	DLC		7x0,185x154°	CR Nozzle
<b>7190512</b>	DLLA140P 1420	0433 171 881	CP			8x0,19x140°	Nozzle
<b>7190513</b>	DLLA157P 1424	0433 171 886	CP	DLC		7x0,16x157°	CR Nozzle
<b>7190514</b>	DLLA157P 1425	0433 171 887	CP	DLC		6x0,17x157°	CR Nozzle
<b>7190518</b>	DLLA150P 1437	0433 171 889	CP	DLC		6x0,12x150°	Nozzle
<b>719052</b>	DLLA146P 1453	0433 171 900				6x0,31x146°	Nozzle
<b>7190521</b>	DLLA152P 1454	0433 171 901	CP			8x0,19x152°	Nozzle
<b>7190522</b>	DLLA153P 1455	0433 171 902	CP			8x0,18x153°	Nozzle
<b>719053</b>	DLLA148P 1460	0433 171 904				6x0,275x148°	Nozzle
<b>719054</b>	DLLA148P 1461	0433 171 905				6x0,265x148°	Nozzle
<b>719055</b>	DLLA148P 1462	0433 171 906				6x0,24x148°	Nozzle
<b>7190550</b>	DLLA149P 1471/	0433 171 914	CP	DLC		6x0,12x149°	CR Nozzle
<b>7190551</b>	DLLA155P 1493	0433 171 921	CP	DLC		6x0,15x155°	CR Nozzle
<b>71905512</b>	DLLA158P 1500	0433 171 924	CP	DLC		Ø3.5 - 7x0,155x158°	CR Nozzle
<b>719055124</b>	DLLA155P 1514	0433 171 935	CP	DLC		6x0,16x155°	CR Nozzle
<b>719055125</b>	DLLA149P 1515/	0433 171 936	CP	DLC		6x0,13x149°	CR Nozzle

Our Ref.	Stamping	Part Number	CP	DLC	D/A	Technical Data	Description
<b>719055126</b>	DLLA145P 1517	0433 171 937	CP			8x0,205x145°	UIS Nozzle
<b>719055127</b>	DLLA148P 1524++	0433 171 939	CP	DLC		8x0,195x148°	CR Nozzle
<b>719055129</b>	DLLA143P 1532	0433 171 944					CR Nozzle
<b>71905513</b>	DLLA138P 1533	0433 171 945	CP	DLC		8x0,14x138°	CR Nozzle
<b>71905514</b>	DLLA145P 1534	0433 171 946	CP			8x0,20x145°	UIS Nozzle
<b>71905516</b>	DLLA143P 1536	0433 171 947	CP	DLC		8x0,15x143°	CR Nozzle
<b>71905518</b>	DLLA154P 1538+	0433 171 948	CP			7x0,205x154°	Nozzle
<b>71905519</b>	DLLA144P 1539	0433 171 949	CP	DLC		7x0,20x144°	CR Nozzle
<b>7190552</b>	DLLA145P 1540	0433 171 950	CP			8x0,16x145°	UIS Nozzle
<b>71905521</b>	DLLA146P 1545	0433 171 953	CP	DLC		Ø3.5 - 8x0,165x146°	CR Nozzle
<b>719055211</b>	DLLA152P 1546	0433 171 954	CP	DLC		Ø3.5 - 6x0,185x152°	CR Nozzle
<b>71905522</b>	DLLA150P 1557	0433 171 960	CP	DLC		6x0,15x150°	CR Nozzle
<b>719055227</b>	DLLA149P 1562	0433 171 961	CP	DLC		8x0,16x149°	CR Nozzle
<b>719055229</b>	DLLA150P 1564	0433 171 963	CP	DLC		7x0,18X150°	CR Nozzle
<b>71905523</b>	DLLA144P 1565	0433 171 964	CP	DLC		8x0,20x144°	CR Nozzle
<b>71905524</b>	DLLA150P 1566	0433 171 965	CP	DLC		7x0,21x150°	CR Nozzle
<b>71905525</b>	DLLA137P 1577	0433 171 966	CP	DLC		8x0,15x137°	CR Nozzle
<b>71905526</b>	DLLA146P 1581	0433 171 968	CP	DLC		7x0,195x146°	CR Nozzle
<b>71905527</b>	DLLA146P 1583	0433 171 969				8x0,27x148°	Nozzle
<b>71905528</b>	DLLA142P 1595	0433 171 974	CP	DLC		8x0,12x142°	CR Nozzle
<b>7190553</b>	DLLA122P 1602	0433 171 978	CP			7x0,22x122°	Nozzle
<b>71905534</b>	DLLA153P 1608	0433 171 982	CP	DLC		8x0,15x153°	CR Nozzle
<b>71905535</b>	DLLA146P 1610	0433 171 984	CP	DLC		8x0,145x146°	CR Nozzle
<b>71905536</b>	DLLA159P 1611/	0433 171 985	CP	DLC		Ø3.5 - 6x0,15x159°	CR Nozzle
<b>71905539</b>	DLLA143P 1619	0433 171 988	CP	DLC		7x0,165x143°	CR Nozzle
<b>7190554</b>	DLLA150P 1622	0433 171 991	CP	DLC		8x0,185x150°	CR Nozzle
<b>7190556</b>	DLLA145P 1647	0433 172 010	CP	DLC		6x0,155x145°	CR Nozzle
<b>7190558</b>	DLLA142P 1654	0433 172 015	CP	DLC		8x0,175x142°	CR Nozzle
<b>7190559</b>	DLLA145P 1655	0433 172 016	CP	DLC		8x0,20x145°	CR Nozzle
<b>719056</b>	DLLA151P 1656	0433 172 017	CP	DLC		7x0,16x151°	CR Nozzle
<b>7190562</b>	DLLA148P 1660	0433 172 019	CP	DLC		7x0,145x148°	CR Nozzle
<b>7190563</b>	DLLA152P 1661+	0433 172 020	CP	DLC		8x0,115x152°	CR Nozzle
<b>7190566</b>	DLLA150P 1666	0433 172 022	CP	DLC		6x0,16x150°	CR Nozzle
<b>7190568</b>	DLLA82P 1668	0433 172 024	CP	DLC		6x0,15x82°	CR Nozzle
<b>719057</b>	DLLA155P 1674	0433 172 026	CP	DLC		6x0,16x155°	CR Nozzle
<b>7190575</b>	DLLA152P 1681	0433 172 029	CP	DLC		7x0,125x152°	CR Nozzle
<b>7190578</b>	DLLA145P 1686	0433 172 033	CP	DLC		7x0,165x145°	CR Nozzle
<b>719058</b>	DLLA148P 1688	0433 172 034	CP	DLC		7x0,17x148°	CR Nozzle
<b>7190582</b>	DLLA152P 1690	0433 172 036	CP	DLC		8x0,18x152°	CR Nozzle
<b>7190583</b>	DLLA118P 1691	0433 172 037	CP	DLC		5x0,20x118°	CR Nozzle
<b>71905836</b>	DLLA143P 1696	0433 172 039	CP	DLC		8x0,215x143°	CR Nozzle
<b>71905837</b>	DLLA118P 1697	0433 172 040	CP	DLC		5x0,22x118°	CR Nozzle
<b>71905838</b>	DLLA147P 1702	0433 172 044	CP	DLC		6x0,15x147°	CR Nozzle
<b>7190584</b>	DLLA142P 1709	0433 172 047	CP	DLC		7x0,205x142°	CR Nozzle
<b>71905849</b>	DLLA139P 1711	0433 172 048	CP	DLC			CR Nozzle
<b>7190585</b>	DLLA150P 1712	0433 172 049	CP	DLC		8x0,225x150°	CR Nozzle
<b>71905852</b>	DLLA145P 1714	0433 172 051	CP	DLC		6x0,25x145°	CR Nozzle
<b>7190586</b>	DLLA144P 1707	0433 172 045	CP	DLC		7x0,21x144°	CR Nozzle
<b>7190587</b>	DLLA145P 1720	0433 172 055	CP	DLC		6x0,145x145°	CR Nozzle
<b>7190588</b>	DLLA153P 1721	0433 172 056	CP	DLC		8x0,195x153°	CR Nozzle
<b>719059</b>	DLLA146P 1724	0433 172 058	CP	DLC		7x0,205x146°	CR Nozzle
<b>7190591</b>	DLLA146P 1725	0433 172 059	CP	DLC		7x0,19x146°	CR Nozzle
<b>7190592</b>	DLLA148P 1726	0433 172 060	CP	DLC		8x0,215x148°	CR Nozzle
<b>7190595</b>	DLLA150P 1734	0433 172 061	CP	DLC		7x0,13x150°	CR Nozzle

Our Ref.	Stamping	Part Number	CP	DLC	D/A	Technical Data	Description
<b>7190596</b>	DLLA145P 1738	0433 172 062	CP	DLC		6x0,15x145°	CR Nozzle
<b>7190597</b>	DLLA147P 1740	0433 172 064					CR Nozzle
<b>7190598</b>	DLLA150P 1744	0433 172 067	CP	DLC			CR Nozzle
<b>7190599</b>	DLLA132P 1755	0433 172 074	CP			6x0,19x133°	Nozzle
<b>719060</b>	DLLA152P 1768	0433 172 078	CP	DLC		7x0,195x152°	CR Nozzle
<b>7190609</b>	DLLA122P 1779	0433 172 086				8x0,215x122°	Nozzle
<b>719061</b>	DLLA160P 1780	0433 172 087	CP	DLC		7x0,22x160°	Nozzle
<b>7190611</b>	DLLA150P 1781	0433 172 088	CP	DLC		7x0,155x150°	CR Nozzle
<b>7190613</b>	DLLA149P 1787	0433 172 091	CP	DLC		8x0,19x149°	CR Nozzle
<b>7190614</b>	DLLA145P 1794	0433 172 093	CP	DLC		Ø3.5 - 8x0,175x145°	CR Nozzle
<b>7190615</b>	DLLA154P 1795	0433 172 094	CP	DLC		7x0,19x154°	CR Nozzle
<b>7190629</b>	DLLA147P 1814	0433 172 107	CP	DLC		Ø3.5 - 7x0,185x147°	CR Nozzle
<b>719063</b>	DLLA148P 1815	0433 172 108	CP	DLC		7x0,195x148°	CR Nozzle
<b>7190634</b>	DLLA152P 1819	0433 172 111	CP	DLC		7x0,21x152°	CR Nozzle
<b>7190637</b>	DLLA150P 1827	0433 172 115	CP	DLC		8x0,17x150°	CR Nozzle
<b>7190638</b>	DLLA150P 1828	0433 172 116	CP	DLC		8x0,17x150°	CR Nozzle
<b>71906387</b>	DLLA153P 1831/	0433 172 119	CP	DLC		Ø3.5 - 9x0,13x153°	CR Nozzle
<b>7190639</b>	DLLA152P 1832/	0433 172 120	CP	DLC		Ø3.5 - 9x0,14x152°	CR Nozzle
<b>7190641</b>	DLLA150P 2118	0433 172 118	CP	DLC		6x0,14x150°	CR Nozzle
<b>7190643</b>	DLLA150P 2123	0433 172 123	CP	DLC		8x0,145x150°	CR Nozzle
<b>71906431</b>	DLLA146P 2124	0433 172 124	CP	DLC		Ø3.5 - 8x0,148x146°	CR Nozzle
<b>71906435</b>	DLLA151P 2128	0433 172 128	CP	DLC		6x0,13x151°	CR Nozzle
<b>71906436</b>	DLLA148P 2129	0433 172 129	CP	DLC		7x0,12x148°	CR Nozzle
<b>7190644</b>	DLLA145P 2135	0433 172 135	CP			6x0,165x145°	CR Nozzle
<b>71906441</b>	DLLA155P 2136	0433 172 136	CP	DLC		7x0,115x155°	CR Nozzle
<b>71906442</b>	DLLA152P 2137	0433 172 137	CP	DLC		7x0,12x152°	CR Nozzle
<b>71906448</b>	DLLA150P 2143	0433 172 143	CP	DLC		7x0,155x150°	CR Nozzle
<b>71906449</b>	DLLA145P 2144	0433 172 144	CP	DLC		Ø3.5 - 8x0,15x145°	CR Nozzle
<b>7190645</b>	DLLA146P 2145	0433 172 145	CP	DLC		Ø3.5 - 8x0,17x146°	CR Nozzle
<b>71906456</b>	DLLA141P 2146	0433 172 146	CP	DLC		8x0,15x141°	CR Nozzle
<b>71906457</b>	DLLA150P 2147	0433 172 147	CP	DLC		7x0,135x150°	CR Nozzle
<b>719064573</b>	DLLA145P 2150	0433 172 150	CP	DLC		Ø3.5 - 8x0,145x145°	CR Nozzle
<b>71906458</b>	DLLA150P 2153	0433 172 153	CP	DLC		Ø3.5 - 8x0,15x150°	CR Nozzle
<b>71906459</b>	DLLA150P 2154	0433 172 154	CP	DLC		8x0,15x150°	CR Nozzle
<b>7190646</b>	DLLA143P 2155	0433 172 155	CP	DLC		Ø3.5 - 8x0,17x143°	CR Nozzle
<b>7190647</b>	DLLA148P 2158	0433 172 158	CP	DLC		Ø3.5 - 9x0,175x148°	CR Nozzle
<b>7190648</b>	DLLA162P 2160+	0433 172 160	CP	DLC		Ø3.5 - 8x0,12x152°	CR Nozzle
<b>7190649</b>	DLLA146P 2161/	0433 172 161	CP	DLC		Ø3.5 - 7x0,215x146°	CR Nozzle
<b>719065</b>	DLLA149P 2166	0433 172 166	CP	DLC		8x0,215x149°	CR Nozzle
<b>7190652</b>	DLLA145P 2168	0433 172 168	CP	DLC		7x0,155x145°	CR Nozzle
<b>71906523</b>	DLLA147P 2172	0433 172 172	CP	DLC		Ø3.5 - 8x0,195x147°	CR Nozzle
<b>71906525</b>	DLLA160P 2176	0433 172 176	CP	DLC		Ø3.5 - 8x0,13x160°	CR Nozzle
<b>71906527</b>	DLLA154P 2178	0433 172 178	CP			7x0,195x152°	Nozzle
<b>7190653</b>	DLLA158P 2181					8x0,23x158°	Nozzle
<b>71906531</b>	DLLA151P 2182	0433 172 182	CP	DLC		7x0,21x151°	CR Nozzle
<b>7190654</b>	DLLA120P 2185	0433 172 185	CP	DLC		Ø3.5 - 6x0,23x120°	CR Nozzle
<b>71906543</b>	DLLA153P 2189	0433 172 189	CP	DLC		8x0,18x153°	CR Nozzle
<b>71906546</b>	DLLA150P 2197	0433 172 197	CP	DLC		8x0,175x150°	CR Nozzle
<b>7190655</b>	DLLA128P 2201	0433 172 201	CP	DLC		5x0,22x128°	CR Nozzle
<b>7190656</b>	DLLA118P 2203	0433 172 203	CP	DLC		5x0,22x118°	CR Nozzle
<b>7190657</b>	DLLA153P 2210	0433 172 210	CP	DLC		7x0,17x153°	CR Nozzle
<b>7190658</b>	DLLA146P 2213	0433 172 213					CR Nozzle
<b>7190659</b>	DLLA152P 2217	0433 172 217	CP	DLC		8x0,155x152°	CR Nozzle
<b>71906592</b>	DLLA150P 2219	0433 172 219	CP	DLC		8x0,138x150°	CR Nozzle

Our Ref.	Stamping	Part Number	CP	DLC	D/A	Technical Data	Description
<b>719066</b>	DLLA148P 2221	0433 172 221	CP	DLC		8x0,195x148°	CR Nozzle
<b>7190660</b>	DLLA148P 2222	0433 172 222	CP	DLC		8x0,196x148°	CR Nozzle
<b>7190661</b>	DLLA139P 2229	0433 172 229	CP	DLC		7x0,12x140°	CR Nozzle
<b>71906612</b>	DLLA148P 2232	0433 172 232	CP	DLC		8x0,20x148°	UIS Nozzle
<b>71906613</b>	DLLA145P 2236	0433 172 236	CP	DLC		8x0,20x145°	CR Nozzle
<b>71906614</b>	DLLA149P 2239	0433 172 239	CP	DLC		6x0,12x149°	CR Nozzle
<b>71906615</b>	DLLA151P 2240	0433 172 240	CP	DLC		8x0,196x151°	CR Nozzle
<b>71906617</b>	DLLA138P 2246	0433 172 246	CP	DLC		6x0,15x138°	CR Nozzle
<b>7190662</b>	DLLA150P 2259	0433 172 259	CP	DLC		8x0,16x150°	CR Nozzle
<b>7190663</b>	DLLA142P 2262	0433 172 262	CP	DLC		8x0,155x142°	CR Nozzle
<b>7190664</b>	DLLA145P 2270	0433 172 270	CP	DLC		8x0,14x145°	CR Nozzle
<b>7190665</b>	DLLA144P 2273	0433 172 273	CP	DLC		7x0,21x144°	CR Nozzle
<b>71906655</b>	DLLA140P 2281	0433 172 281	CP	DLC		6x0,135x140°	CR Nozzle
<b>7190666</b>	DLLA163P 2291+						CR Nozzle
<b>7190668</b>	DLLA154P 2302	0433 172 302	CP	DLC		Ø3.5 - 7x0,105x154°	CR Nozzle
<b>71906684</b>	DLLA155P 2307	0433 172 307	CP	DLC		8x0,105x155°	CR Nozzle
<b>7190669</b>	DLLA150P 2339	0433 172 339	CP	DLC		8x0,138x150°	CR Nozzle
<b>71906692</b>	DLLA152P 2344	0433 172 344	CP	DLC		7x0,185x152°	CR Nozzle
<b>71906693</b>	DLLA138P 2355	0433 172 355	CP	DLC		7x0,135x138°	CR Nozzle
<b>71906694</b>	DLLA148P 2369	0433 172 369	CP	DLC		8x0,19x148°	CR Nozzle
<b>71906695</b>	DLLA146P 2370	0433 172 370	CP	DLC		Ø3.5 - 8x0,145x146°	CR Nozzle
<b>719066955</b>	DLLA160P 2380	0433 172 380	CP	DLC		Ø3.5 - 7x0,12x160°	CR Nozzle
<b>71906696</b>	DLLA150P 2386	0433 172 386	CP	DLC		8x0,192x150°	CR Nozzle
<b>71906698</b>	DLLA145P 2397	0433 172 397	CP	DLC		8x0,17x145°	CR Nozzle
<b>719066981</b>	DLLA160P 2398	0433 172 398	CP	DLC		Ø3.5 - 7x0,12x160°	CR Nozzle
<b>719066985</b>	DLLA155P 2400+	0433 172 400	CP	DLC		Ø3.5 - 7x0,13x155°	CR Nozzle
<b>719066986</b>	DLLA156P 2401	0433 172 401	CP	DLC			CR Nozzle
<b>71906699</b>	DLLA150P 2440	0433 172 440	CP	DLC		7x0,14x150°	CR Nozzle
<b>7190670</b>	DLLA156P 2457	0433 172 457	CP	DLC			CR Nozzle
<b>7190671</b>	DLLA156P 2458	0433 172 458	CP	DLC		Ø3.5 - 7x0,105x156°	CR Nozzle
<b>7190674</b>	DLLA147P 2474	0433 172 474	CP	DLC		8x0,18x147°	CR Nozzle
<b>71908</b>	DLLA150P 2641+		CP	DLC		8x0,10x150°	CR Nozzle
<b>71911</b>	DSLA155P 84	0433 175 004				4x0,31x155°	Nozzle
<b>71912</b>	DSLA155P 104	0433 175 005				4x0,35x155°	Nozzle
<b>71914</b>	DSLA150P 143	0433 175 006				4x0,245x150°	Nozzle
<b>71915</b>	DSLA155P 170	0433 175 007				5x0,31x155°	Nozzle
<b>71916</b>	DSLA150P 191+/-	0433 175 013	CP			5x0,21x150°	2 Springs Nozzle
<b>71917</b>	DSLA145P 208	0433 175 017				5x0,24x145°	2 Springs Nozzle
<b>719171</b>	DSLA160P 192	0433 175 014				5x0,31x160°	Nozzle
<b>719176</b>	DSLA124P 198	0433 175 016				4x0,28x124°	Nozzle
<b>71918</b>	DSLA150P 211	0433 175 018				5x0,26x150°	Nozzle
<b>71919</b>	DSLA148P 219	0433 175 020				6x0,30x148°	Nozzle
<b>71931</b>	DSLA150P 261	0433 175 029				5x0,24x150°	2 Springs Nozzle
<b>719327</b>	DSLA145P 263	0433 175 031				5x0,245x145°	Nozzle
<b>71933</b>	DSLA145P 265	0433 175 033				6x0,25x145°	Nozzle
<b>71934</b>	DSLA145P 268	0433 175 036				8x0,22x145°	Nozzle
<b>719341</b>	DSLA145P 269	0433 175 037				8x0,24x145°	Nozzle
<b>719345</b>	DSLA155P 276	0433 175 039				4x0,34x155°	Nozzle
<b>719347</b>	DSLA155P 278	0433 175 040				5x0,31x155°	Nozzle
<b>71935</b>	DSLA150P 280-	0433 175 042	CP			5x0,18x150°	2 Springs Nozzle
<b>71936</b>	DSLA140P 292	0433 175 044				5x0,27x140°	Nozzle
<b>71937</b>	DSLA150P 294	0433 175 046	CP			5x0,19x150°	Nozzle
<b>71940</b>	DSLA145P 300	0433 175 048				5x0,29x145°	Nozzle
<b>71941</b>	DSLA145P 311M					6x0,25x145°	Nozzle

Our Ref.	Stamping	Part Number	CP	DLC	D/A	Technical Data	Description
<b>71942</b>	DSLA130P 320	0433 175 051				5x0,30x130°	Nozzle
<b>71943</b>	DSLA130P 321	0433 175 052				5x0,32x130°	Nozzle
<b>71944</b>	DSLA 78P 322	0433 175 053				1x0,52x78°	Nozzle
<b>71950</b>	DSLA145P 330	0433 175 054				5x0,23x145°	Nozzle
<b>71957</b>	DSLA150P 357	0433 175 058	CP			5x0,19x150°	2 Springs Nozzle
<b>71962</b>	DSLA150P 362	0433 175 059	CP			5x0,21x150°	2 Springs Nozzle
<b>71964</b>	DSLA145P 366	0433 175 061				5x0,26x145°	2 Springs Nozzle
<b>719665</b>	DSLA145P 379	0433 175 062	CP			8x0,23x145°	Nozzle
<b>719666</b>	DSLA145P 380	0433 175 063	CP			8x0,23x145°	Nozzle
<b>719667</b>	DSLA140P 381	0433 175 064				7x0,22x140°	Nozzle
<b>719668</b>	DSLA145P 396	0433 175 066				5x0,23x145°	Nozzle
<b>719669</b>	DSLA140P 400	0433 175 067				5x0,27x140°	Nozzle
<b>71967</b>	DSLA141P 405	0433 175 068				5x0,26x141°	Nozzle
<b>719677</b>	DSLA150P 442	0433 175 072	CP			5x0,185x150°	2 Springs Nozzle
<b>71968</b>	DSLA145P 446	0433 175 073				5x0,22x145°	2 Springs Nozzle
<b>71969</b>	DSLA150P 448	0433 175 074				5x0,23x150°	Nozzle
<b>719691</b>	DSLA145P 462	0433 175 076				5x0,23x145°	Nozzle
<b>7196912</b>	DSLA145P 463	0433 175 077				5x0,245x145°	Nozzle
<b>7196914</b>	DSLA145P 464	0433 175 078				5x0,23x145°	Nozzle
<b>7196916</b>	DSLA135P 468	0433 175 079				5x0,28x135°	Nozzle
<b>719692</b>	DSLA 88P 480	0433 175 082				4x0,31x88°	Nozzle
<b>719693</b>	DSLA148P 482	0433 175 083				5x0,225x148°	Nozzle
<b>719694</b>	DSLA154P 492/	0433 175 085	CP			7x0,23x154°	Nozzle
<b>719695</b>	DSLA150P 502	0433 175 087	CP			5x0,21x150°	2 Springs Nozzle
<b>719704</b>	DSLA150P 520	0433 175 093	CP			5x0,205x150°	2 Springs Nozzle
<b>719705</b>	DSLA128P 523	0433 175 094				5x0,265x128°	Nozzle
<b>719706</b>	DSLA147P 535	0433 175 095	CP			5x0,19x147°	2 Springs Nozzle
<b>719708</b>	DSLA145P 537	0433 175 096	CP			8x0,255x145°	Nozzle
<b>71971</b>	DSLA134P 546	0433 175 099				6x0,28x134°	Nozzle
<b>719715</b>	DSLA148P 575	0433 175 107	CP			5x0,22x148°	2 Springs Nozzle
<b>719719</b>	DSLA148P 591	0433 175 110	CP			5x0,22x148°	2 Springs Nozzle
<b>71973</b>	DSLA145P 603	0433 175 113					Nozzle
<b>71974</b>	DSLA134P 604	0433 175 114				5x0,26x134°	Nozzle
<b>719749</b>	DSLA145P 619	0433 175 117	CP			5x0,19x145°	Nozzle
<b>71975</b>	DSLA154P 620	0433 175 118				5x0,235x154°	Nozzle
<b>71976</b>	DSLA145P 626	0433 175 125				5x0,22x145°	Nozzle
<b>71977</b>	DSLA145P 631	0433 175 121	CP			5x0,21x145°	2 Springs Nozzle
<b>719771</b>	DSLA145P 631+	0433 175 121	CP			5x0,215x145°	2 Springs Nozzle
<b>71978</b>	DSLA135P 633	0433 175 122				5x0,265x135°	Nozzle
<b>71979</b>	DSLA140P 640	0433 175 124				5x0,225x140°	2 Springs Nozzle
<b>71980</b>	DSLA150P 645	0433 175 130				5x0,25x150°	Nozzle
<b>719801</b>	DSLA150P 646	0433 175 131	CP			5x0,165x150°	2 Springs Nozzle
<b>719803</b>	DSLA150P 661	0433 175 136	CP			5x0,17x150°	2 Springs Nozzle
<b>719805</b>	DSLA150P 672	0433 175 139	CP			5x0,16x150°	2 Springs Nozzle
<b>719806</b>	DSLA150P 672-	0433 175 360	CP			5x0,16x150°	2 Springs Nozzle
<b>719808</b>	DSLA142P 683	0433 175 142	CP			5x0,18x142°	2 Springs Nozzle
<b>71981</b>	DSLA150P 706	0433 175 150	CP			5x0,175x150°	2 Springs Nozzle
<b>71982</b>	DSLA139P 710	0433 175 152	CP			5x0,215x139°	2 Springs Nozzle
<b>719824</b>	DSLA147P 716	0433 175 156	CP			5x0,19x147°	2 Springs Nozzle
<b>719832</b>	DSLA156P 736	0433 175 163	CP	DLC	D/A	6x0,175x156°	CR Nozzle
<b>719833</b>	DSLA156P 737	0433 175 164	CP	DLC	D/A	6x0,145x156°	CR Nozzle
<b>7198334</b>	DSLA140P 739	0433 175 165	CP			8x0,21x140°	Nozzle
<b>719834</b>	DSLA140P 741	0433 175 167	CP			8x0,19x140°	Nozzle
<b>7198345</b>	DSLA150P 745	0433 175 168	CP			5x0,145x150°	Nozzle

Our Ref.	Stamping	Part Number	CP	DLC	D/A	Technical Data	Description
<b>7198348</b>	DSLA147P 759	0433 175 173	CP			7x0,20x147°	Nozzle
<b>719835</b>	DSLA145P 763	0433 175 175	CP	DLC		5x0,185x145°	CR Nozzle
<b>719836</b>	DSLA145P 763+		CP	DLC		5x0,185x145°	CR Nozzle
<b>7198364</b>	DSLA150P 764	0433 175 176	CP			5x0,21x150°	2 Springs Nozzle
<b>7198368</b>	DSLA142P 770/	0433175 178	CP		D/A		Nozzle
<b>719837</b>	DSLA134P 772	0433 175 179				5x0,25x134°	2 Springs Nozzle
<b>719838</b>	DSLA150P 773	0433 175 180	CP			7x0,19x150°	2 Springs Nozzle
<b>71984</b>	DSLA134P 781	0433 175 188				6x0,28x134°	2 Springs Nozzle
<b>719843</b>	DSLA150P 783	0433 175 189	CP		D/A	5x0,19x150°	UIS Nozzle
<b>719844</b>	DSLA150P 784	0433 175 190	CP			6x0,18x148°	Nozzle
<b>71985</b>	DSLA155P 789	0433 175 192	CP			5x0,145x155°	CR Nozzle
<b>719851</b>	DSLA142P 792	0433 175 194	CP			5x0,18x142°	Nozzle
<b>719852</b>	DSLA142P 795	0433 175 196	CP	DLC		5x0,18x142°	CR Nozzle
<b>7198527</b>	DSLA153P 797	0433 175 197	CP			7x0,195x153°	Nozzle
<b>7198528</b>	DSLA153P 798	0433 175 198	CP			7x0,19x153°	Nozzle
<b>719853</b>	DSLA150P 800/	0433 175 199	CP		D/A	5x0,15x150°	UIS Nozzle
<b>7198531</b>	DSLA153P 801	0433 175 200	CP			7x0,185x153°	Nozzle
<b>719854</b>	DSLA153P 802	0433 175 201	CP			7x0,17x153°	Nozzle
<b>7198543</b>	DSLA153P 803	0433 175 202	CP	DLC		7x0,18x153°	Nozzle
<b>7198544</b>	DSLA136P 804		CP	DLC	D/A	5x0,205x136°	CR Nozzle
<b>719855</b>	DSLA136P 804/	0433 175 203	CP	DLC	D/A	5x0,205x136°	CR Nozzle
<b>71986</b>	DSLA134P 816	0433 175 208				6x0,28x134°	Nozzle
<b>719861</b>	DSLA153P 820	0433 175 210	CP			7x0,205x153°	Nozzle
<b>719863</b>	DSLA150P 838	0433 175 219	CP			5x0,205x150°	2 Springs Nozzle
<b>719865</b>	DSLA150P 855	0433 175 227	CP		D/A	5x0,16x150°	UIS Nozzle
<b>7198658</b>	DSLA144P 860	0433 175 229	CP			5x0,215x143°	Nozzle
<b>719866</b>	DSLA140P 862+	0433 175 230	CP	DLC		5x0,185x140°	CR Nozzle
<b>719868</b>	DSLA145P 864+	0433 175 232	CP	DLC		5x0,175x145°	CR Nozzle
<b>719870</b>	DSLA150P 873		CP			5x0,19x150°	2 Springs Nozzle
<b>719872</b>	DSLA145P 882	0433 175 246	CP			6x0,205x145°	2 Springs Nozzle
<b>7198725</b>	DSLA142P 921	F002 C40 504				5x0,235x142°	Nozzle
<b>719873</b>	DSLA157P 955	0433 175 267	CP			7x0,185x157°	Nozzle
<b>719874</b>	DSLA154P 960	0433 175 269	CP			7x0,22x154°	Nozzle
<b>719875</b>	DSLA143P 970	0433 175 271	CP	DLC	D/A	8x0,16x143°	CR Nozzle
<b>719876</b>	DSLA144P 971+	0433 175 272	CP	DLC		6x0,15x144°	CR Nozzle
<b>719878</b>	DSLA144P 973+	0433 175 274	CP	DLC		6x0,155x144°	CR Nozzle
<b>719879</b>	DSLA158P 974+	0433 175 275	CP	DLC	D/A	7x0,165x158°	CR Nozzle
<b>71988</b>	DSLA145P 975	0433 175 276	CP			5x0,225x145°	2 Springs Nozzle
<b>719884</b>	DSLA145P 987	0433 175 280	CP			5x0,16x145°	Nozzle
<b>719887</b>	DSLA128P 997	F002 C40 515				5x0,265x128°	Nozzle
<b>719891</b>	DSLA150P 1019	0433 175 291	CP			5x0,21x150°	2 Springs Nozzle
<b>719892</b>	DSLA144P 1021	0433 175 288	CP	DLC		6x0,165x144°	CR Nozzle
<b>719893</b>	DSLA142P 1025	0433 175 294	CP		D/A	6x0,15x142°	2 Springs Nozzle
<b>7198939</b>	DSLA140P 1033/	0433 175 297	CP	DLC	D/A	6x0,18x140°	CR Nozzle
<b>719894</b>	DSLA154P 1034	0433 175 298	CP	DLC	D/A	6x0,175x154°	CR Nozzle
<b>719895</b>	DSLA144P 1037/	0433 175 300				5x0,24x144°	Nozzle
<b>719897</b>	DSLA150P 1042	0433 175 303	CP		D/A	5x0,19x150°	UIS Nozzle
<b>719898</b>	DSLA150P 1043	0433 175 304	CP		D/A	5x0,195x150°	UIS Nozzle
<b>7198985</b>	DSLA150P 1045	0433 175 306	CP		D/A	5x0,18x150°	UIS Nozzle
<b>719899</b>	DSLA146P 1055/	0433 175 308					CR Nozzle
<b>71990</b>	DSLA143P 1058	0433 175 309	CP	DLC	D/A	8x0,16x143°	CR Nozzle
<b>719909</b>	DSLA142P 1074	F002 C40 529				6x0,275x145°	Nozzle
<b>71991</b>	DSLA156P 1079/+	0433 175 314	CP	DLC	D/A	7x0,13x156°	CR Nozzle
<b>719914</b>	DSLA145P 1091	0433 175 318	CP		D/A	5x0,20x145°	CR Nozzle

Our Ref.	Stamping	Part Number	CP	DLC	D/A	Technical Data	Description
<b>719917</b>	DSLA145P 1097	0433 175 319	CP			7x0,19x145°	Nozzle
<b>71992</b>	DSLA140P 1100	0433 175 321	CP			8x0,20x140°	Nozzle
<b>719923</b>	DSLA150P 1103	0433 175 323	CP		D/A	6x0,21x150°	2 Springs Nozzle
<b>719925</b>	DSLA140P 1112	0433 175 325	CP			5x0,215x140°	2 Springs Nozzle
<b>719930</b>	DSLA154P 1129/	0433 175 333	CP		D/A	6x0,13x154°	CR Nozzle
<b>719931</b>	DSLA140P 1131	0433 175 334	CP			5x0,125x140°	CR Nozzle
<b>719934</b>	DSLA143P 1154	0433 175 341				6x0,23x143°	Nozzle
<b>719935</b>	DSLA150P 1156	0433 175 343	CP		D/A	5x0,185x150°	UIS Nozzle
<b>719936</b>	DSLA145P 1167	F000 430 908					Nozzle
<b>719938</b>	DSLA140P 1173	0433 175 347				5x0,23x140°	Nozzle
<b>7199381</b>	DSLA145P 1174	0433 175 348	CP			6x0,22x143°	Nozzle
<b>719939</b>	DSLA142P 1186	F002 C40 547	CP			6x0,185x142°	Nozzle
<b>719940</b>	DSLA152P 1191/	0433 175 354	CP		D/A		Nozzle
<b>7199405</b>	DSLA128P 1198	0433 175 357				5X0,23x128°	Nozzle
<b>719941</b>	DSLA144P 1213	0433 175 363	CP			6x0,16x144°	CR Nozzle
<b>719945</b>	DSLA153P 1242++	0433 175 366	CP	DLC	D/A	7x0,145x153°	CR Nozzle
<b>719947</b>	DSLA150P 1247	0433 175 367	CP		D/A	5x0,17x150°	UIS Nozzle
<b>7199471</b>	DSLA150P 1248	0433 175 368	CP		D/A	5x0,19x150°	UIS Nozzle
<b>719948</b>	DSLA150P 1250	0433 175 369	CP			6x0,16x150°	2 Springs Nozzle
<b>7199483</b>	DSLA145P 1253	0433 175 370	CP			6x0,20x145°	Nozzle
<b>719949</b>	DSLA152P 1282	F002 C40 560					Nozzle
<b>719950</b>	DSLA152P 1287++	0433 175 379	CP		D/A	6x0,165x152°	UIS Nozzle
<b>719951</b>	DSLA144P 1295	0433 175 386	CP			6x0,165x144°	CR Nozzle
<b>719953</b>	DSLA151P 1302	0433 175 387				6x0,22x151°	Nozzle
<b>719954</b>	DSLA124P 1309	0433 175 390	CP	DLC	D/A	5x0,21x124°	CR Nozzle
<b>719956</b>	DSLA154P 1320	0433 175 395	CP	DLC	D/A	6x0,17x154°	CR Nozzle
<b>719957</b>	DSLA156P 1336	0433 175 402	CP		D/A	6x0,153x156°	UIS Nozzle
<b>719958</b>	DSLA156P 1381	0433 175 411	CP		D/A	5x0,152x156°	UIS Nozzle
<b>719959</b>	DSLA146P 1409+	0433 175 414	CP	DLC	D/A	6x0,225x146°	UIS Nozzle
<b>719961</b>	DSLA156P 1411	0433 175 416	CP			8x0,16x156°	Nozzle
<b>719963</b>	DSLA146P 1440	F002 C40 586				6x0,245x146°	Nozzle
<b>719964</b>	DSLA145P 1441	0433 175 426	CP			6x0,20x140°	Nozzle
<b>719969</b>	DSLA150P 1452	0433 175 428					UIS Nozzle
<b>719978</b>	DSLA148P 1468	0433 175 429	CP		D/A	6x0,18x148°	UIS Nozzle
<b>719980</b>	DSLA142P 1474	0433 175 431	CP			5x0,175x142°	CR Nozzle
<b>7199805</b>	DSLA145P 1479	0433 175 438					Nozzle
<b>7199806</b>	DSLA150P 1485	0433 175 437	CP		D/A	6x0,16x150°	UIS Nozzle
<b>7199807</b>	DSLA150P 1489	0433 175 441	CP		D/A	5x0,195x150°	UIS Nozzle
<b>7199808</b>	DSLA150P 1491	0433 175 444	CP		D/A	5x0,155x150°	UIS Nozzle
<b>719981</b>	DSLA150P 1499	0433 175 447	CP		D/A	5x0,18x150°	UIS Nozzle
<b>7199815</b>	DSLA150P 1508	0433 175 448	CP		D/A	5x0,145x150°	UIS Nozzle
<b>719982</b>	DSLA128P 1510	0433 175 449	CP	DLC	D/A	5x0,205x128°	CR Nozzle
<b>719983</b>	DSLA150P 1585	0433 175 460	CP		D/A	6x0,165x150°	UIS Nozzle
<b>719984</b>	DSLA150P 1586	0433 175 461	CP		D/A	5x0,16x150°	UIS Nozzle
<b>719985</b>	DSLA152P 1603	0433 175 462	CP			8X0,19X153°	Nozzle
<b>719989</b>	DSLA124P 1659	0433 175 470	CP	DLC	D/A	5x0,21x124°	CR Nozzle
<b>719990</b>	DSLA145P 1679	0433 175 472	CP			6x0,23x145°	Nozzle
<b>719992</b>	DSLA153P 1710	0433 175 478	CP	DLC		6x0,245x153°	Nozzle
<b>719993</b>	DSLA140P 1723	0433 175 481	CP	DLC	D/A	8x0,16x140°	CR Nozzle
<b>719994</b>	DSLA150P 1729	0433 175 484	CP			5x0,195x150°	Nozzle
<b>7199943</b>	DSLA150P 1767	F002 C40 683				5x0,27x150°	Nozzle
<b>7199945</b>	DSLA160P 1786	0433 175 489					Nozzle
<b>7199948</b>	DSLA143P 5499	0433 175 499	CP	DLC	D/A	8x0,155x143°	CR Nozzle
<b>7199949</b>	DSLA124P 5500	0433 175 500	CP	DLC	D/A	5x0,195x124°	CR Nozzle

<i>Our Ref.</i>	<i>Stamping</i>	<i>Part Number</i>	<i>CP</i>	<i>DLC</i>	<i>D/A</i>	<i>Technical Data</i>	<i>Description</i>
<b>719995</b>	DSLA143P 5501	0433 175 501	CP	DLC	D/A	8x0,155x143°	CR Nozzle
<b>719996</b>	DSLA128P 5510	0433 175 510	CP	DLC	D/A	5x0,20x128°	CR Nozzle
<b>719997</b>	DSLA124P 5516	0433 175 516	CP	DLC	D/A	5x0,205x124°	CR Nozzle
<b>7199971</b>	DSLA143P 5517	0433 175 517	CP	DLC	D/A	8x0,15x143°	CR Nozzle
<b>719998</b>	DSLA143P 5519	0433 175 519	CP	DLC	D/A	8x0,155x143°	CR Nozzle
<b>71P210</b>	F00VX20010		CP	DLC		8x0,135x157°	Piezo Nozzle
<b>71P217</b>	F00VX20017		CP	DLC		7x0,14x158°	Piezo Nozzle
<b>71P307</b>	F00VX30007		CP	DLC		6x0,15x160°	Piezo Nozzle
<b>71P322</b>	F00VX30022		CP	DLC		7x0,14x160°	Piezo Nozzle
<b>71P326</b>	F00VX30026		CP	DLC		7x0,14x160°	Piezo Nozzle
<b>71P341</b>	F00VX30041		CP	DLC		7x0,14x160°	Piezo Nozzle
<b>71P379</b>	F00VX30079		CP	DLC		7x0,14x157°	Piezo Nozzle
<b>71P401</b>	F00VX40001		CP	DLC			Piezo Nozzle
<b>71P414</b>	F00VX40014		CP	DLC		7x0,14x151°	Piezo Nozzle
<b>71P421</b>	F00VX40021		CP	DLC		6x0,15X157°	Piezo Nozzle
<b>71P423</b>	F00VX40023		CP	DLC			Piezo Nozzle
<b>71P429</b>	F00VX40029		CP	DLC		8x0,12x164°	Piezo Nozzle
<b>71P430</b>	F00VX40030		CP	DLC		8x0,12x160°	Piezo Nozzle
<b>71P460</b>	F00VX40060		CP	DLC		8x0,14x149°	Piezo Nozzle
<b>71P465</b>	F00VX40065		CP	DLC		8x0,12x158°	Piezo Nozzle
<b>71P466</b>	F00VX40066		CP	DLC		8x0,11x157°	Piezo Nozzle
<b>71P478</b>	F00VX40078		CP	DLC		8x0,12x157°	Piezo Nozzle
<b>71P538</b>	F00VX50038		CP	DLC		6x0,21x143°	CRIN 4.2 Nozzle
<b>71P559</b>	F00VX50059		CP	DLC		6x0,19x137°	CRIN 4.2 Nozzle
<b>71P583</b>	F00VX50083		CP	DLC		7x0,21x144°	CRIN 4.2 Nozzle
<b>71P5974</b>	F00VX50174		CP	DLC		7x0,18x141°	CRIN 4.2 Nozzle
<b>71P5975</b>	F00VX50175		CP	DLC		8x0,195x149°	CRIN 4.2 Nozzle
<b>71P5976</b>	F00VX50176		CP	DLC		7x0,195x144°	CRIN 4.2 Nozzle
<b>NBD10092</b>	DL140T 92	0433 300 132				7x0,30x140°	Nozzle
<b>NBD10093</b>	DL155T 92	0433 300 184				7x0,30x155°	Nozzle
<b>NBD10126</b>	DL140T 226	0433 300 136				8x0,35x140°	Nozzle
<b>NBD10132</b>	DL140T 232	0433 300 137				8x0,40x140°	Nozzle
<b>NBD10160</b>	DL140T 260	0433 300 138				8x0,30x140°	Nozzle
<b>NBD10169</b>	DL141T 269					9x0,26x141°	Nozzle
<b>NBD10179</b>	DL143T 279					9x0,27x143°	Nozzle
<b>NBD10218</b>	DL150T 418	0433 300 172				8x0,20x150°	Nozzle
<b>NBD10455</b>	DL110T 957	0433 300 056				8x0,25x110°	Nozzle
<b>NBD10456</b>	DL125T 957	0433 300 091				8x0,25x125°	Nozzle
<b>NBD10457</b>	DL150T 957	0433 300 180				8x0,25x150°	Nozzle
<b>NBD10458</b>	DL110T 958	0433 300 057				6x0,25x110°	Nozzle
<b>NBD10459</b>	DL150T 958	0433 300 181				6x0,25x150°	Nozzle
<b>NBD10465</b>	DL140T 965	0433 300 149				7x0,50x140°	Nozzle
<b>NBD10515</b>	DL160T 1015	0433 300 206				6x0,33x160°	Nozzle
<b>NBD10523</b>	DL150T 1023	0433 300 210				8x0,31x150°	Nozzle
<b>NBD10571</b>	DL125T 1071	0433 300 237				8x0,23x125°	Nozzle
<b>NBD10613</b>	DL145T 1113	0433 300 258				8x0,425x145°	Nozzle
<b>NBD10619</b>	DL140T 1119	0433 300 259				7x0,45x140°	Nozzle
<b>NBD10621</b>	DL145T 1121	0433 300 260				9x0,30x145°	Nozzle
<b>NBD10622</b>	DL145T 1122	0433 300 261				8x0,46x145°	Nozzle
<b>NBD10625</b>	DL110T 1125	0433 300 264				5x0,40x110°	Nozzle
<b>NBD10629</b>	DL140T 1129	0433 300 266				8x0,40x140°	Nozzle
<b>NBD10639</b>	DL150T 1139	0433 300 270				8x0,40x150°	Nozzle
<b>NBD10652</b>	DL130T 1152	0433 300 281				6x0,40x130°	Nozzle
<b>NBD10655</b>	DL140T 1155	0433 300 286				8x0,35x140°	Nozzle

Our Ref.	Stamping	Part Number	CP	DLC	D/A	Technical Data	Description
<b>Bosch</b>							
NBD10667	DL110T 1167	0433 300 294				5x0,38x110°	Nozzle
NBD10669	DL145T 1169	0433 300 296				9x0,35x145°	Nozzle
NBD10672	DL140T 1172	0433 300 300				10x0,36x140°	Nozzle
NBD10686	DL155T 1186	0433 300 307				8x0,35x155°	Nozzle
NBD10687	DL145T 1187	0433 300 308				8x0,34x145°	Nozzle
NBD10690	DL110T 1190	0433 300 311				4x0,50x110°	Nozzle
NBD10691	DL135T 1191	0433 300 312				1+8x0,30x135°	Nozzle
NBD10697	DL150T 1197	0433 300 320				8x0,40x150°	Nozzle
NBD10698	DL145T 1198	0433 300 319				8x0,30x145°	Nozzle
NBD10701	DL145T 1201	0433 300 322				9x0,325x145°	Nozzle
NBD107011	DL145T 1201	0433 300 986				9x0,325x145°	Nozzle
NBD10703	DL145T 1203	0433 300 323				9x0,325x145°	Nozzle
NBD10705	DL145T 1205	0433 300 325				9x0,35x145°	Nozzle
NBD107051	DL145T 1205	0433 300 983				9x0,35x145°	Nozzle
NBD10706	DL155T 1206	0433 300 326				8x0,40x155°	Nozzle
NBD10715	DL130T 1215	0433 300 334				7x0,47x130°	Nozzle
NBD10729	DL155T 1229	0433 300 342				5x0,43x155°	Nozzle
NBD10743	DL155T 1243	0433 300 346				5x0,45x155°	Nozzle
NBD10748	DL155T 1248	0433 300 347				5x0,47x155°	Nozzle
NBD20007	DLLB145T 7	0433 371 007				8x0,375x145°	Nozzle
NBD24021	DLF145T 21	0433 351 024				8x0,34x145°	Nozzle
NBD24030	DLF160T 30	0433 351 033				7x0,34x160°	Nozzle
NBD24037	DLF145T 37	0433 351 040				8x0,30x145°	Nozzle
NBD25002	DLLF155T 2	0433 351 054				8x0,40x155°	Nozzle
NBD25003	DLLF155T 3	0433 351 055				8x0,35x155°	Nozzle
NBD25008	DLLF145T 8	0433 351 040				8x0,30x145°	Nozzle
NBD25009	DLLF145T 9	0433 351 051				8x0,38x145°	Nozzle
NBD25014	DLLF156T 14	0433 351 061		DLC		5x0,30+4x0,26	Nozzle
NBD27013	DLLZ150T 13	0433 371 013				10x0,38x150°	Nozzle
NBD27016	DLLA154T 16	0433 371 015		DLC			Nozzle
NBD27060	DLLZ150T 1160	F00B L0D 025					Nozzle
NBD27061	DLLZ150T 1160C			DLC			Nozzle
NBD27062	DLLZ150T 1161C	F00B L0D 037		DLC			Nozzle
NBD27067	DLLZ150T 1167C	F00B L0D 023		DLC			Nozzle
NBD27086	B433 120 086 C					10x0,36x150°	Nozzle
NBD27218	B433 120 218			DLC			Nozzle
NBD27258	B433 235 258 C						Nozzle
NBD30045	DL160U 45					9x0,45x160°	Nozzle
NBD30132	DL130U 232	0433 400 044				8x0,40x130°	Nozzle
NBD30146	DL130U 246	0433 400 046				8x0,45x130°	Nozzle
NBD30156	DL150U 256	0433 400 076				9x0,45x150°	Nozzle
NBD30599	DL135U 1099	0433 400 110				8x0,53x135°	Nozzle
NBD30620	DL115U 1120	0433 400 116				6x0,45°x115°	Nozzle
NBD35006	DLF150U 6	0433 451 041				8x0,45x150°	Nozzle
NBD35044	DLF150U 44	0433 451 051				8x0,45x150°	Nozzle
NBD35045	DLF145U 45	0433 451 052				10x0,49x145°	Nozzle
NBD35561	DLF145VV-C3440061					9x0,69x145°	Nozzle
NBD35627	DLZ150U 1227	0433 450 004				6x0,73x150°	Nozzle
NBD35639	DLZ155U 1239	0433 450 008					Nozzle
NBD36001	DLLA152U 1	0433 421 002				8x0,35x152°	Nozzle
NNN20161	B433 120 161					8x0,42x146°	Nozzle
NNN4010	B433 539 159	4010977				10x0,29x165°	Nozzle

## Caterpillar

Our Ref.	Stamping	Part Number	CP	DLC	D/A	Technical Data	Description
<b>Caterpillar</b>							
442006	Nozzle Assy. OR9348	HI300					HEUI Nozzle
442016	Nozzle Assy. OR9349	HI300					HEUI Nozzle
442026	Nozzle Assy. OR9350	HI300					HEUI Nozzle
59005	100 7556						Pencil Nozzle
59006	100 7558						Pencil Nozzle
59007	100 7559						Pencil Nozzle
59009	130 5187						Pencil Nozzle
59010	170 5181						Pencil Nozzle
59011	170 5187						Pencil Nozzle
59014	3S 6638	Group (Nozzle 8N5986)					Nozzle
59024	4W 7015						Pencil Nozzle
59025	4W 7016						Pencil Nozzle
59026	4W 7017						Pencil Nozzle
59027	4W 7018						Pencil Nozzle
59028	4W 7019						Pencil Nozzle
59029	4W 7022						Pencil Nozzle
59031	5F 2805						Nozzle
59034	5H 7936	Group (Nozzle 8N3173)					Nozzle
59040	6H 3364	Group (Nozzle 9H4113)					Nozzle
59046	7M 4601						Nozzle
59048	7M 7431	Group (Nozzle 7M4601)					Nozzle
59052	7N 9843						Nozzle
59059	7W 7026						Pencil Nozzle
59060	7W 7032						Pencil Nozzle
59061	7W 7037						Pencil Nozzle
59064	8M 1584	Group (Nozzle 8N4697)					Nozzle
59066	8N 1831						Nozzle
59067	8N 3173						Nozzle
59068	8N 3175						Nozzle
59070	8N 3176						Nozzle
59072	8N 3177						Nozzle
59074	8N 4694						Nozzle
59076	8N 4697						Nozzle
590763	8N 5986						Nozzle
590768	8N 7003						Pencil Nozzle
59077	8N 7005						Pencil Nozzle
59078	8N 8796	Group (Nozzle 8N4694)					Nozzle
59080	9F 2393	Group (Nozzle 5F2805)					Nozzle
59082	9F 4113						Nozzle
59084	9L 6884						Nozzle
59086	9N 3246						Nozzle
59088	9N 6173						Nozzle
76440	106-7056		CP			6x0,18x152°	HEUI Nozzle
7941006	41006/32	OR9348/10R1257 - HI300				6x0,17	HEUI Nozzle
7941007	41007/32	OR1050/10R1050 - HI300					HEUI Nozzle
7941016	41016/32	OR9349 - HI300				6x0,185	HEUI Nozzle
7941026	41026/32	OR9350 - HI300				6x0,17	HEUI Nozzle
7941036	41036/32	10R0781 - HI300				6x0,19	HEUI Nozzle
7941046	41046/32	10R0782/10R1262 - HI300				6x0,18	HEUI Nozzle
7941056	41056/32	10R1306 - HI300					HEUI Nozzle
7941406	41406/32	OR9348/OR9350/10R1257 -					HEUI Nozzle
7941407	41407/32	OR1050/10R1050 - HI300					HEUI Nozzle
7941416	41416/32	OR9349/10R0782/10R1262					HEUI Nozzle
7941446	41446/32	10R0781 - HI300					HEUI Nozzle

Our Ref.	Stamping	Part Number	CP	DLC	D/A	Technical Data	Description
<b>7941456</b>	41456/32	10R1306 - HI300					HEUI Nozzle
<b>7941466</b>	41466/32	10R8999 - HI300					HEUI Nozzle
<b>79608</b>	Inj. 235-2888	C9 - 950HC	CP	DLC	D/A	6x0,165x130°	HEUI Nozzle
<b>79608A</b>	Inj. 235-2888	ASSY	CP	DLC	D/A	6x0,165x130°	HEUI Nozzle
<b>79611</b>	Inj. 10R9001/10R7221	C-9	CP			5x0,20x128°	HEUI Nozzle
<b>79611A</b>	Inj. 10R9001/10R7221	ASSY	CP			5x0,20x128°	HEUI Nozzle
<b>79612</b>	Inj. 10R4764/10R7222	C9	CP			5x0,24x126°	HEUI Nozzle
<b>79612A</b>	Inj. 10R4764/10R7222	ASSY	CP			5x0,24x126°	HEUI Nozzle
<b>79616</b>	Inj. 10R4844/10R7223	C9 - C-9	CP			5x0,23x126°	HEUI Nozzle
<b>79616A</b>	Inj. 10R4844/10R7223	ASSY	CP			5x0,23x126°	HEUI Nozzle
<b>79623</b>	Inj. 10R4763/10R7225	C7 - C9 - 329D	CP			6x0,20x135°	HEUI Nozzle
<b>79623A</b>	Inj. 10R4763/10R7225	ASSY	CP			6x0,20x135°	HEUI Nozzle
<b>79627</b>	Inj. 10R4761	C7	CP			6x0,17x136°	HEUI Nozzle
<b>79627A</b>	Inj. 10R4761	ASSY	CP			6x0,17x136°	HEUI Nozzle
<b>79628</b>	Inj. 10R4762	C7	CP			6x0,17x134°	HEUI Nozzle
<b>79628A</b>	Inj. 10R4762	ASSY	CP			6x0,17x134°	HEUI Nozzle
<b>79701</b>	Inj. 10R0955	C15 / 3406				6x0,22x132°	HEUI Nozzle
<b>79701A</b>	Inj. 10R0955	ASSY				6x0,22x132°	HEUI Nozzle
<b>79702</b>	Inj. 10R0956	C15 / 3406				6x0,195x130°	HEUI Nozzle
<b>79702A</b>	Inj. 10R0956	ASSY				6x0,195x130°	HEUI Nozzle
<b>79703</b>	Inj. 10R0957	C15 / 3406	CP			6x0,23x132°	HEUI Nozzle
<b>79703A</b>	Inj. 10R0957	ASSY	CP			6x0,23x132°	HEUI Nozzle
<b>79704</b>	Inj. 10R0958	C15 / 3406				6x0,23x130°	HEUI Nozzle
<b>79704A</b>	Inj. 10R0958	ASSY				6x0,23x130°	HEUI Nozzle
<b>79705</b>	Inj. 10R0963	C12 / 3196	CP			6x0,20x130°	HEUI Nozzle
<b>79705A</b>	Inj. 10R0963	ASSY	CP			6x0,20x130°	HEUI Nozzle
<b>79706</b>	Inj. 10R0967	C10 / 3176C	CP			6x0,18x150°	HEUI Nozzle
<b>797065</b>	Inj. 10R1000/10R1273	C15 / 3406					HEUI Nozzle
<b>797065A</b>	Inj. 10R1000/10R1273	ASSY					HEUI Nozzle
<b>79706A</b>	Inj. 10R0967	ASSY	CP			6x0,18x150°	HEUI Nozzle
<b>79707</b>	Inj. 10R1275	3516B	CP			10x0,265x160°	HEUI Nozzle
<b>79707A</b>	Inj. 10R1275	ASSY	CP			10x0,265x160°	HEUI Nozzle
<b>79708</b>	Inj. 10R1305	C13					HEUI Nozzle
<b>797085</b>	Inj. 10R1814	C12					HEUI Nozzle
<b>797085A</b>	Inj. 10R1814	ASSY					HEUI Nozzle
<b>79708A</b>	Inj. 10R1305	ASSY					HEUI Nozzle
<b>79709</b>	Inj. 10R2977	C13					HEUI Nozzle
<b>79709A</b>	Inj. 10R2977	ASSY					HEUI Nozzle
<b>79710</b>	Inj. 10R3262	C11 / C13	CP			6x0,215x132°	HEUI Nozzle
<b>797102</b>	Inj. 10R3265	C27					HEUI Nozzle
<b>797102A</b>	Inj. 10R3265	ASSY					HEUI Nozzle
<b>79710A</b>	Inj. 10R3262	ASSY	CP			6x0,215x132°	HEUI Nozzle
<b>79715</b>	Inj. CH12013	Perkins 2806	CP			6x0,29x130°	HEUI Nozzle
<b>79715A</b>	Inj. CH12013	ASSY	CP			6x0,29x130°	HEUI Nozzle
<b>79717</b>	Inj. CH12071	3406E	CP			6x0,32x131°	HEUI Nozzle
<b>79720</b>	Inj. CH10948	3406E	CP			6x0,30x132°	HEUI Nozzle
<b>79720A</b>	Inj. CH10948	ASSY	CP			6x0,30x132°	HEUI Nozzle
<b>79727</b>	Inj. 20R1271	C13 / C15 / 3512 / 3516	CP			8x0,29x160°	HEUI Nozzle
<b>79727A</b>	Inj. 20R1271	ASSY	CP			8x0,29x160°	HEUI Nozzle
<b>79732</b>	Inj. 10R2772/CH11945	C15 / C18 / C32	CP			6x0,28x133°	HEUI Nozzle
<b>79732A</b>	Inj. 10R2772/CH11945	ASSY	CP			6x0,28x133°	HEUI Nozzle
<b>79739</b>	Inj. 20R2284	C18 / C32	CP			6x0,23x130°	HEUI Nozzle
<b>79739A</b>	Inj. 20R2284	ASSY	CP			6x0,23x130°	HEUI Nozzle
<b>79740</b>	Inj. 20R2285	C15 / C27	CP			6x0,217x125°	HEUI Nozzle

Our Ref.	Stamping	Part Number	CP	DLC	D/A	Technical Data	Description
----------	----------	-------------	----	-----	-----	----------------	-------------

## Caterpillar

79740A	Inj. 20R2285	ASSY	CP			6x0,217x125°	HEUI Nozzle
79842	2645A742	C6.6	CP	DLC	D/A	6X0,17X129°	CR Nozzle
79845	2645A745	C6.6	CP	DLC	D/A	6x0,14x124°	CR Nozzle
79847	2645A747	C4.4/C6.6	CP	DLC	D/A	6x0,165x131°	CR Nozzle
79849	2645A749	C6.6	CP	DLC	D/A	6x0,183x131°	CR Nozzle
79861	32F61-00061	315D/318D/319D	CP	DLC	D/A	6x0,165x137°	CR Nozzle
79862	32F61-00062	320D/321D/323D	CP	DLC	D/A	6x0,155x134°	CR Nozzle

## Cummins

58116	3071046	PTD SC				7x.0073x14°	Nozzle
58175	3073575	PTD N				8x.0076x17°	Nozzle
7641071	3076071	N14				8x0,20	Celect Nozzle
7641081	3079963	L10					Celect Nozzle
7641091	3084592	N14					Celect Nozzle
7641101	3087791	M11					Celect Nozzle
7641175	3088175	N14					Celect Nozzle
7641243	3095043	M11 Plus				8x0,19	Celect Nozzle
7641329	3095729	M11					Celect Nozzle
7641334	3095734	M11					Celect Nozzle
7641378	3409978	N14					Celect Nozzle
7641388	3411388	N14 Plus				8x0,21	Celect Nozzle
7641404	3411404	M11					Celect Nozzle
7641430	3411690	N14					Celect Nozzle
7641434	3411694	NTA14-E					Celect Nozzle
7641452	3609852	N14					Celect Nozzle
7641455	3609855	N14 Plus				8x0,20	Celect Nozzle
7641461	3609861	N14					Celect Nozzle
7641525	3609925	M11 Plus				8x0,19	Celect Nozzle
7641575	4026225	M11					Celect Nozzle
7641604	4061854	M11					Celect Nozzle
7641610	4307525	M11					Celect Nozzle
7641615	4307779	M11					Celect Nozzle
7641620	4384384	M11					Celect Nozzle
7641624	4902924	M11					Celect Nozzle
7641628	4902928	M11					Celect Nozzle
7641642	4903322	M11					Celect Nozzle
7641675	4903475	M11					Celect Nozzle
7641684	4928174	M11					Celect Nozzle
78820	3331242						ISX Nozzle
78830	3348357						ISX Nozzle
78850	4076965						ISX Nozzle
78860	4088303						ISX Nozzle
78865	4088566						ISX Nozzle
78870	4088652						ISX Nozzle
78875	4088662						ISX Nozzle
78881	4902823						ISX Nozzle
78885	4954432						ISX Nozzle
78890	4954886						ISX Nozzle

## Delphi

42209	BDN0SPC 6209	5650091					Pintle Nozzle
42236	BDN12SD 6236	5643085					Pintle Nozzle
42290	BDN12SPC 6290	5651241					Pintle Nozzle
42299	BDN4SD 6299	5643095					Pintle Nozzle

<i>Our Ref.</i>	<i>Stamping</i>	<i>Part Number</i>	<i>CP</i>	<i>DLC</i>	<i>D/A</i>	<i>Technical Data</i>	<i>Description</i>
<b>42389</b>	BDN0SPC 6389	5650300					Pintle Nozzle
<b>42453</b>	BDN4SD 6453	5643320					Pintle Nozzle
<b>42517</b>	BDN12SD 6517	5643450					Pintle Nozzle
<b>42577</b>	BDN0SD 6577	5643410					Pintle Nozzle
<b>425772</b>	BDN0SD 6577B	5643413					Pintle Nozzle
<b>42596</b>	BDN0SD 6596	5641870					Pintle Nozzle
<b>42651</b>	BDN0SPC 6651	5650350					Pintle Nozzle
<b>42751</b>	BDN0SD 6751	5641891					Pintle Nozzle
<b>427513</b>	BDN0SD 6751C	5641906					Pintle Nozzle
<b>428493</b>	BDN12SD 6849C	5643075					Pintle Nozzle
<b>428624</b>	BDN12SD 6862D	5643091					Pintle Nozzle
<b>428725</b>	BDN12SD 6872E	5643482					Pintle Nozzle
<b>428864</b>	BDN4SDC 6886D	5643326					Pintle Nozzle
<b>428874</b>	BDN0SDC 6887D	5641921					Pintle Nozzle
<b>42902</b>	BDN0SDC 6902	5641934					Pintle Nozzle
<b>42903</b>	BDN0SDC 6903	5641935					Pintle Nozzle
<b>49046</b>	BDL30S 46	5611065					Nozzle
<b>49054</b>	BDL30S 54	5611070					Nozzle
<b>49133</b>	BDL110S 6133	5611650				2x0.35x110°	Nozzle
<b>49167</b>	BDL110S 6267	5611735				2x0.35x110°	Nozzle
<b>70000</b>	BDLL150S 559	5620405				4x0.25x150°	Nozzle
<b>70001</b>	BDLL150S 609	5620465				4x0.30x150°	Nozzle
<b>70002</b>	BDLL150S 685S	5620621				4x0.28x150°	Nozzle
<b>70003</b>	BDLL120S 694	5620645				2x0.40x120°	Nozzle
<b>70004</b>	BDLL140S 6001	5620655				4x0.25x140°	Nozzle
<b>70006</b>	BDLL150S 6028	5620680				4x0.28x150°	Nozzle
<b>70007</b>	BDLL150S 6054	5620695				4x0.30x150°	Nozzle
<b>70008</b>	BDLL150S 6064	5620705				4x0.35x150°	Nozzle
<b>70010</b>	BDLL150S 6072B	5620722				4x0.30x150°	Nozzle
<b>70011</b>	BDLL150S 6078	5620725				4x0.28x150°	Nozzle
<b>70012</b>	BDLL135S 6092	5620741				3x0.35x135°	Nozzle
<b>70013</b>	BDLL150S 6097S	5620755				4x0.25x150°	Nozzle
<b>70014</b>	BDLL150S 6123	5620780				4x0.27x150°	Nozzle
<b>70015</b>	BDLL150S 6130A	5620790				4x0.35x150°	Nozzle
<b>70016</b>	BDLL150S 6138	5620805				4x0.30x150°	Nozzle
<b>70017</b>	BDLL150S 6144	5620810				4x0.26x150°	Nozzle
<b>70018</b>	BDLL150S 6156	5620835				4x0.40x150°	Nozzle
<b>70019</b>	BDLL150S 6159	5620840				4x0.25x150°	Nozzle
<b>70020</b>	BDLL160S 6173	5620855				4x0.25x160°	Nozzle
<b>70021</b>	BDLL150S 6176	5620860				4x0.27x150°	Nozzle
<b>70022</b>	BDLL140S 6183	5620865				3x0.27x140°	Nozzle
<b>70023</b>	BDLL140S 6192	5620890				4x0.20x140°	Nozzle
<b>70024</b>	BDLL140S 6193	5620895				4x0.25x140°	Nozzle
<b>70025</b>	BDLL150S 6194	5620900				4x0.28x150°	Nozzle
<b>70026</b>	BDLL140S 6205	5620915				4x0.29x140°	Nozzle
<b>70027</b>	BDLL140S 6205A	5620916				4x0.29x140°	Nozzle
<b>700275</b>	BDLL140S 6221	5620945				3x0.27x140°	Nozzle
<b>70028</b>	BDLL150S 6222	5620950				4x0.27x150°	Nozzle
<b>70029</b>	BDLL150S 6225	5620960				4x0.27x150°	Nozzle
<b>70030</b>	BDLL160S 6246	5620997				4x0.25x160°	Nozzle
<b>70031</b>	BDLL150S 6253	5620998				3x0.33x150°	Nozzle
<b>70032</b>	BDLL140S 6254	5621000				4x0.35x140°	Nozzle
<b>70033</b>	BDLL140S 6258	5621002				4x0.35x140°	Nozzle
<b>70034</b>	BDLL140S 6268	5621010				3x0.33x140°	Nozzle

<i>Our Ref.</i>	<i>Stamping</i>	<i>Part Number</i>	<i>CP</i>	<i>DLC</i>	<i>D/A</i>	<i>Technical Data</i>	<i>Description</i>
<b>70035</b>	BDLL 80S 6273	5621018				2x0,27+2x0,32	Nozzle
<b>70036</b>	BDLL150S 6275	5621023				4x0,34x150°	Nozzle
<b>70037</b>	BDLL140S 6276	5621025				4x0,21x140°	Nozzle
<b>70038</b>	BDLL140S 6281	5621029				4x0,30x140°	Nozzle
<b>70039</b>	BDLL160S 6283	5621033				4x0,25x160°	Nozzle
<b>70040</b>	BDLL150S 6288A	5621036				4x0,27x150°	Nozzle
<b>70041</b>	BDLL176S 6297					4x0,25x140°	Nozzle
<b>70042</b>	BDLL140S 6298	5621046				3x0,28x140°	Nozzle
<b>70043</b>	BDLL150S 6302	5621047				3x0,42x150°	Nozzle
<b>70044</b>	BDLL135S 6303	5621050				3x0,43x135°	Nozzle
<b>70045</b>	BDLL140S 6306	5621057				4x0,35x140°	Nozzle
<b>70047</b>	BDLL150S 6310	5621065				4x0,27x150°	Nozzle
<b>70048</b>	BDLL150S 6317	5621072				3x0,30x150°	Nozzle
<b>70049</b>	BDLL150S 6318	5621074				4x0,40x150°	Nozzle
<b>70050</b>	BDLL120S 6325	5621080				4x0,27x120°	Nozzle
<b>70051</b>	BDLL150S 6329CF	5621085				4x0,25x150°	Nozzle
<b>700519</b>	BDLL150S 6347					4x0,41x150°	Nozzle
<b>70052</b>	BDLL150S 6348	5621098				4x0,43x150°	Nozzle
<b>70053</b>	BDLL140S 6350	5621103				3x0,35x140°	Nozzle
<b>70054</b>	BDLL150S 6355	5621110				4x0,26x150°	Nozzle
<b>70055</b>	BDLL150S 6372	5621120				4x0,26x150°	Nozzle
<b>70056</b>	BDLL150S 6382	5621125				4x0,25x150°	Nozzle
<b>70057</b>	BDLL150S 6385A	5621181				4x0,32x150°	Nozzle
<b>70058</b>	BDLL160S 6394	5621206				4x0,27x160°	Nozzle
<b>70059</b>	BDLL150S 6395	5621208				4x0,35x150°	Nozzle
<b>70060</b>	BDLL150S 6397	5621212				4x0,36x150°	Nozzle
<b>70061</b>	BDLL160S 6402	5621225				4x0,25x160°	Nozzle
<b>70062</b>	BDLL150S 6403	5621227				4x0,29x150°	Nozzle
<b>70063</b>	BDLL150S 6407	5621229				4x0,30x150°	Nozzle
<b>70064</b>	BDLL150S 6408	5621231				4x0,27x150°	Nozzle
<b>70065</b>	BDLL 10S 6410A	5621236				1x0,58x10°	Nozzle
<b>70066</b>	BDLL176S 6414	5621243				4x0,28x140°	Nozzle
<b>70067</b>	BDLL140S 6417	5621245				4x0,28x140°	Nozzle
<b>70068</b>	BDLL140S 6422	5621251				4x0,30x140°	Nozzle
<b>70069</b>	BDLL140S 6423	5621253				4x0,28x140°	Nozzle
<b>70070</b>	BDLL150S 6429	5621260				4x0,27x150°	Nozzle
<b>70071</b>	BDLL140S 6433	5621280				4x0,27x140°	Nozzle
<b>70072</b>	BDLL150S 6435	5621285				4x0,28x150°	Nozzle
<b>70073</b>	BDLL150S 6438	5621290				4x0,30x150°	Nozzle
<b>70074</b>	BDLL140S 6439	5621295				3x0,25x140°	Nozzle
<b>70075</b>	BDLL150S 6443	5621330				4x0,29x150°	Nozzle
<b>70076</b>	BDLL140S 6445	5621335				4x0,26x140°	Nozzle
<b>70077</b>	BDLL150S 6448	5621345				4x0,30x150°	Nozzle
<b>70078</b>	BDLL140S 6455	5621405				4x0,23x140°	Nozzle
<b>70079</b>	BDLL150S 6457	5621407				4x0,34x150°	Nozzle
<b>70081</b>	BDLL150S 6469	5621510				4x0,27x150°	Nozzle
<b>70082</b>	BDLL140S 6471	5621512				4x0,31x140°	Nozzle
<b>70083</b>	BDLL150S 6471	5621511				4x0,33x150°	Nozzle
<b>70084</b>	BDLL150S 6472	5621513				4x0,29x150°	Nozzle
<b>70085</b>	BDLL150S 6476	5621517				4x0,31x150°	Nozzle
<b>70086</b>	BDLL160S 6492	5621535				4x0,30x160°	Nozzle
<b>70087</b>	BDLL150S 6495	5621538				4x0,38x150°	Nozzle
<b>700871</b>	BDLL150S 6501	5621544				4x0,29x150°	Nozzle
<b>70088</b>	BDLL150S 6502	5621545				4x0,32x150°	Nozzle

<i>Our Ref.</i>	<i>Stamping</i>	<i>Part Number</i>	<i>CP</i>	<i>DLC</i>	<i>D/A</i>	<i>Technical Data</i>	<i>Description</i>
<b>70089</b>	BDLL150S 6506	5621549				4x0,29x150°	Nozzle
<b>70090</b>	BDLL150S 6507	5621550				4x0,28x150°	Nozzle
<b>70091</b>	BDLL150S 6508	5621551				4x0,35x150°	Nozzle
<b>70092</b>	BDLL 10S 6509	5621552				1x0,60x10°	Nozzle
<b>70093</b>	BDLL150S 6511	5621554				4x0,30x150°	Nozzle
<b>70094</b>	BDLL150S 6513	5621556				4x0,28x150°	Nozzle
<b>70095</b>	BDLL160S 6519	5621562				4x0,34x160°	Nozzle
<b>70096</b>	BDLL 18S 6522	5621565				1x0,57x18°	Nozzle
<b>70097</b>	BDLL150S 6542	5621585				4x0,33x150°	Nozzle
<b>70098</b>	BDLL150S 6545	5621588				4x0,30x150°	Nozzle
<b>70099</b>	BDLL160S 6550	5621593				5x0,29x160°	Nozzle
<b>70100</b>	BDLL160S 6551	5621594				4x0,30x160°	Nozzle
<b>70101</b>	BDLL150S 6552	5621595				4x0,35x150°	Nozzle
<b>70102</b>	BDLL150S 6554	5621597				4x0,25x150°	Nozzle
<b>70103</b>	BDLL150S 6555	5621598				4x0,27x150°	Nozzle
<b>70104</b>	BDLL150S 6556	5621599				4x0,28x150°	Nozzle
<b>70105</b>	BDLL150S 6557	5621600				4x0,28x150°	Nozzle
<b>70106</b>	BDLL150S 6561	5621604				4x0,25x150°	Nozzle
<b>70107</b>	BDLL150S 6563	5621606				4x0,32x150°	Nozzle
<b>70108</b>	BDLL160S 6569	5621612				5x0,29x160°	Nozzle
<b>70109</b>	BDLL150S 6571	5621614				4x0,27x150°	Nozzle
<b>70110</b>	BDLL150S 6573	5621616				4x0,29x150°	Nozzle
<b>70112</b>	BDLL150S 6576C	5621620				4x0,28x150°	Nozzle
<b>70114</b>	BDLL140S 6581	5621626				4x0,30x140°	Nozzle
<b>70115</b>	BDLL150S 6582	5621625				4x0,26x150°	Nozzle
<b>70116</b>	BDLL160S 6584	5621628				4x0,26x160°	Nozzle
<b>70117</b>	BDLL150S 6589	5621634				4x0,35x150°	Nozzle
<b>70118</b>	BDLL150S 6591	5621636				4x0,31x150°	Nozzle
<b>70119</b>	BDLL140S 6592	5621637				4x0,28x140°	Nozzle
<b>70120</b>	BDLL150S 6594	5621639				4x0,40x150°	Nozzle
<b>70121</b>	BDLL150S 6599	5621646				4x0,30x150°	Nozzle
<b>70122</b>	BDLL150S 6600	5621647				4x0,30x150°	Nozzle
<b>70123</b>	BDLL150S 6601	5621648				4x0,46x150°	Nozzle
<b>70124</b>	BDLL150S 6602	5621649				4x0,28x150°	Nozzle
<b>70125</b>	BDLL 22S 6604	5621651				1x0,59x22°	Nozzle
<b>70126</b>	BDLL140S 6606	5621653				4x0,38x140°	Nozzle
<b>70127</b>	BDLL150S 6607	5621654				4x0,41x150°	Nozzle
<b>70128</b>	BDLL140S 6608A	5621670				4x0,33x140°	Nozzle
<b>70129</b>	BDLL140S 6609	5621656				4x0,35x140°	Nozzle
<b>70130</b>	BDLL140S 6611	5621657				4x0,32x140°	Nozzle
<b>70131</b>	BDLL150S 6613	5621659				4x0,40x150°	Nozzle
<b>70132</b>	BDLL150S 6617	5621663				4x0,30x150°	Nozzle
<b>70133</b>	BDLL150S 6618	5621664				4x0,32x150°	Nozzle
<b>70135</b>	BDLL140S 6622	5621669				4x0,30x140°	Nozzle
<b>70137</b>	BDLL140S 6630	5621678				4x0,31x140°	Nozzle
<b>70138</b>	BDLL150S 6634	5621682				4x0,35x150°	Nozzle
<b>70139</b>	BDLL150S 6639	5621685				4x0,30x150°	Nozzle
<b>70140</b>	BDLL150S 6641	5621687				5x0,36x150°	Nozzle
<b>70141</b>	BDLL140S 6644	5621691				4x0,34x140°	Nozzle
<b>70142</b>	BDLL150S 6649CF	5621696				4x0,31x150°	Nozzle
<b>70143</b>	BDLL150S 6654	5621701				4x0,35x150°	Nozzle
<b>70144L</b>	BDLL140S 6655	5621702				3x0,36x140°	Nozzle
<b>70148</b>	BDLL150S 6662	5621709				4x0,29x150°	Nozzle
<b>70149</b>	BDLL150S 6665	5621712				4x0,27x150°	Nozzle

<i>Our Ref.</i>	<i>Stamping</i>	<i>Part Number</i>	<i>CP</i>	<i>DLC</i>	<i>D/A</i>	<i>Technical Data</i>	<i>Description</i>
<b>70150</b>	BDLL150S 6666	5621713				4x0,29x150°	Nozzle
<b>70151</b>	BDLL150S 6667CF	5621714				4x0,33x150°	Nozzle
<b>70152</b>	BDLL150S 6673	5621720				4x0,32x150°	Nozzle
<b>70153</b>	BDLL150S 6676	5621723				4x0,31x150°	Nozzle
<b>70154</b>	BDLL150S 6690	5621737				4x0,35x150°	Nozzle
<b>70155</b>	BDLL150S 6691	5621738				5x0,36x150°	Nozzle
<b>70160</b>	BDLL150S 6698	5621745				4x0,26x150°	Nozzle
<b>70161</b>	BDLL160S 6701	5621749				4x0,34x160°	Nozzle
<b>70162</b>	BDLL160S 6702	5621750				4x0,33x160°	Nozzle
<b>70163</b>	BDLL160S 6703	5621756				4x0,30x160°	Nozzle
<b>70164</b>	BDLL150S 6705CF	5621751				4x0,27x150°	Nozzle
<b>70165</b>	BDLL140S 6707	5621753				4x0,29x140°	Nozzle
<b>70166</b>	BDLL150S 6708C					4x0,32x150°	Nozzle
<b>70167</b>	BDLL150S 6712	5621759				4x0,39x150°	Nozzle
<b>70168</b>	BDLL150S 6713	5621764				4x0,29x150°	Nozzle
<b>70169</b>	BDLL150S 6718CF	5621765				4x0,34x150°	Nozzle
<b>70171</b>	BDLL150S 6730CF	5621777				4x0,31x150°	Nozzle
<b>70172</b>	BDLL150S 6734	5621780				4x0,35x150°	Nozzle
<b>70173</b>	BDLL150S 6737CF	5621784				4x0,30x150°	Nozzle
<b>70174</b>	BDLL150S 6738	5621785				4x0,29x150°	Nozzle
<b>70175</b>	BDLL150S 6740	5621787				4x0,22x150°	Nozzle
<b>701751</b>	BDLL150S 6741CF	5621789				4x0,31x150°	Nozzle
<b>70176</b>	BDLL150S 6743	5621791				4x0,26x150°	Nozzle
<b>701762</b>	BDLL150S 6745	5621792				4x0,27x150°	Nozzle
<b>70178</b>	BDLL150S 6764	5621807				4x0,32x150°	Nozzle
<b>701783</b>	BDLL140S 6768	5621812				4x0,35x140°	Nozzle
<b>70179</b>	BDLL150S 6771	5621814				4x0,27x150°	Nozzle
<b>70180</b>	BDLL150S 6774CF	5621821				4x0,30x150°	Nozzle
<b>70181</b>	BDLL150S 6780CF	5621827				4x0,27x150°	Nozzle
<b>70182</b>	BDLL150S 6781CF	5621828				4x0,35x150°	Nozzle
<b>701823</b>	BDLL150S 6786	5621829				4x0,31x150°	Nozzle
<b>70183</b>	BDLL150S 6789	5621836				6x0,33x150°	Nozzle
<b>70184</b>	BDLL150S 6790CF	5621837				4x0,32x150°	Nozzle
<b>70185</b>	BDLL150S 6792	5621840				4x0,31x150°	Nozzle
<b>701851</b>	BDLL150S 6802	5621849				4x0,31x150°	Nozzle
<b>70186</b>	BDLL150S 6803	5621850				4x0,31x150°	Nozzle
<b>70187</b>	BDLL155S 6807CF	5621854				4x0,28x155°	Nozzle
<b>701872</b>	BDLL150S 6808	5621855				5x0,43x150°	Nozzle
<b>70188</b>	BDLL150S 6812	5621858				4x0,33x150°	Nozzle
<b>70189</b>	BDLL150S 6815	5621861				4x0,31x150°	Nozzle
<b>70190</b>	BDLL150S 6817	5621862				4x0,28x150°	Nozzle
<b>701901</b>	BDLL150S 6826	5621868				5x0,32x150°	Nozzle
<b>701902</b>	BDLL150S 6828CF	5621869				4x0,29x150°	Nozzle
<b>70191</b>	BDLL150S 6829	5621870				4x0,26x150°	Nozzle
<b>701918</b>	BDLL150S 6833CF	5621873				4x0,50x150°	Nozzle
<b>70192</b>	BDLL140S 6835	5621876				4x0,39x140°	Nozzle
<b>701921</b>	BDLL150S 6837	5621877				4x0,30x150°	Nozzle
<b>70193</b>	BDLL150S 6839	5621889				4x0,29x150°	Nozzle
<b>701931</b>	BDLL150S 6840	5621890				4x0,32x150°	Nozzle
<b>70194</b>	BDLL150S 6841	5621891				4x0,31x150°	Nozzle
<b>70196</b>	BDLL150S 6846	5621897				6x0,33x150°	Nozzle
<b>70197C</b>	BDLL124S 6857					4x0,30x124°	Nozzle
<b>70198C</b>	BDLL136S 6858	6801063				3x0,36x136°	Nozzle
<b>70200C</b>	BDLL138S 6859	6801065					Nozzle

Our Ref.	Stamping	Part Number	CP	DLC	D/A	Technical Data	Description
<b>70274</b>	BDLL150S 7574	5621707				4x0,29x150°	Nozzle
<b>70299</b>	BDLL150S 7919	5621874				4x0,30x150°	Nozzle
<b>70300C</b>	DPN 5225					5x0,29x148°	Nozzle
<b>70314</b>	L058 PBA	L058 PBA				5x0,25x143°	Nozzle
<b>70315</b>	L059 PBA	L059 PBA				5x0,25x132°	Nozzle
<b>70316</b>	L060 PBA	L060 PBA				5x0,29x140°	Nozzle
<b>70317</b>	L061 PBA	L061 PBA				5x0,29x143°	Nozzle
<b>70318</b>	L062 PBA	L062 PBA				5x0,24x145°	Nozzle
<b>70319</b>	L063 PBA	L063 PBA				5x0,28x138°	Nozzle
<b>70320</b>	L064 PBA	L064 PBA				5x0,24x144°	Nozzle
<b>70321</b>	L065 PBA	L065 PBA				5x0,30x144°	Nozzle
<b>70322</b>	L066 PBA	L066 PBA				5x0,28x129°	Nozzle
<b>70323</b>	L067 PBA	L067 PBA				5x0,265x143°	Nozzle
<b>70324</b>	L068 PBA	L068 PBA				5x0,26x139°	Nozzle
<b>70326</b>	L069 PBA	L069 PBA				5x0,29x139°	Nozzle
<b>70327</b>	L070 PBA	L070 PBA				5x0,30x141°	Nozzle
<b>70328</b>	L072 PBA	L072 PBA				5x0,25x140°	Nozzle
<b>70329</b>	L074 PBA	L074 PBA	CP			6x0,205x154°	Nozzle
<b>70340</b>	L104 PBA	L104 PBA				5x0,24x145°	Nozzle
<b>70341</b>	L129 PBA	L129 PBA				5x0,28x134°	Nozzle
<b>70342</b>	L130 PBA	L130 PBA				5x0,24x136°	Nozzle
<b>70343</b>	L131 PBA	L131 PBA				5x0,26x140°	Nozzle
<b>703431</b>	L132 PBA	L132 PBA				5x0,28x136°	Nozzle
<b>703434</b>	L143 PBA	L143 PBA					Nozzle
<b>703435</b>	L144 PBA	L144 PBA	CP			6x0,22x144°	Nozzle
<b>703439</b>	L154 PBA	L154 PBA	CP			6x0,20x145°	Nozzle
<b>70344</b>	L155 PBA	L155 PBA				6x0,25x142°	Nozzle
<b>703447</b>	L158 PBA	L158 PBA				6x0,22x140°	Nozzle
<b>703448</b>	L159 PBA	L159 PBA				5x0,29x140°	Nozzle
<b>7034485</b>	L203 PBA	L203 PBA	CP			7x0,24x155°	Nozzle
<b>7034486</b>	L204 PBA	L204 PBA					Nozzle
<b>70345</b>	L276 PBA	L276 PBA				5x0,25x132°	Nozzle
<b>703451</b>	L277 PBA	L277 PBA	CP			5x0,235x137°	Nozzle
<b>703478</b>	L328 PBA	L328 PBA				6x0,23x148°	Nozzle
<b>703479</b>	L330 PBA	L330 PBA				6x0,21x138°	Nozzle
<b>70348</b>	L331 PBA	L331 PBA				6x0,20x137°	Nozzle
<b>70350</b>	L010 PBB	L010 PBB	CP			6x0,21x141°	EUI Nozzle
<b>70351</b>	L011 PBB	L011 PBB	CP			6x0,235x141°	EUI Nozzle
<b>70354</b>	L014 PBB	L014 PBB	CP			6x0,23x152°	EUI Nozzle
<b>70357</b>	L017 PBB	L017 PBB	CP			6x0,23x152°	EUI Nozzle
<b>70358</b>	L018 PBB	L018 PBB	CP			6x0,23x153°	EUI Nozzle
<b>70360</b>	L024 PBB	L024 PBB	CP			6x0,195x152°	EUI Nozzle
<b>70361</b>	L029 PBB	L029 PBB	CP			8x0,21x151°	EUI Nozzle
<b>703642</b>	L092 PBB	L092 PBB	CP			8x0,185x140°	E-Tech Nozzle
<b>703648</b>	L098 PBB	L098 PBB	CP			8x0,205x140°	E-Tech Nozzle
<b>703652</b>	L126 PBB	L126 PBB	CP			6x0,245x150°	Nozzle
<b>70366</b>	L186 PBB	L186 PBB	CP			5x0,20x148°	Nozzle
<b>703663</b>	L191 PBB	L191 PBB	CP			4x0,25x143°	Nozzle
<b>70369</b>	L241 PBB	L241 PBB	CP			9x0,125x156°	Nozzle
<b>703695</b>	L416 PBB	L416 PBB	CP			6x0,27x143°	Nozzle
<b>703699</b>	L023 PBC	L023 PBC				6x0,14x139°	HEUI Nozzle
<b>70370</b>	L025 PBC	L025 PBC	CP			5x0,26x150°	EUI Nozzle
<b>703702</b>	L028 PBC	L028 PBC	CP			5x0,28x145°	EUI Nozzle
<b>7037025</b>	L038 PBC	L038 PBC	CP			5x0,235	EUI Nozzle

<i>Our Ref.</i>	<i>Stamping</i>	<i>Part Number</i>	<i>CP</i>	<i>DLC</i>	<i>D/A</i>	<i>Technical Data</i>	<i>Description</i>
<b>703703</b>	L045 PBC	L045 PBC	CP			6x0,25x150°	EUI Nozzle
<b>7037036</b>	L048 PBC	L048 PBC	CP			6x0,24x150°	EUI Nozzle
<b>703704</b>	L051 PBC	L051 PBC	CP			5x0,245x152°	EUI Nozzle
<b>7037040</b>	L052 PBC	L052 PBC	CP				EUI Nozzle
<b>7037041</b>	L053 PBC	L053 PBC	CP			7x0,21x150°	Smart Nozzle
<b>70370415</b>	L055 PBC	L055 PBC	CP				EUI Nozzle
<b>7037044</b>	L193 PBC	L193 PBC	CP			6x0,25x150°	EUI Nozzle
<b>7037045</b>	L194 PBC	L194 PBC	CP			6x0,23x150°	EUI Nozzle
<b>7037046</b>	L195 PBC	L195 PBC	CP			6x0,22x155°	EUI Nozzle
<b>7037047</b>	L196 PBC	L196 PBC	CP				EUI Nozzle
<b>7037049</b>	L209 PBC	L209 PBC	CP			5x0,245x150°	EUI Nozzle
<b>703705</b>	L210 PBC	L210 PBC	CP			5x0,25x152°	EUI Nozzle
<b>7037052</b>	L211 PBC	L211 PBC	CP			5x0,225x152°	EUI Nozzle
<b>7037055</b>	L215 PBC	L215 PBC	CP			5x0,265x152°	EUI Nozzle
<b>703706</b>	L216 PBC	L216 PBC	CP			5x0,255x151°	EUI Nozzle
<b>703707</b>	L218 PBC	L218 PBC	CP				EUI Nozzle
<b>703708</b>	L221 PBC	L221 PBC	CP			5x0,26x150°	EUI Nozzle
<b>7037082</b>	L222 PBC	L222 PBC	CP			5x0,25x150°	EUI Nozzle
<b>7037083</b>	L223 PBC	L223 PBC	CP				EUI Nozzle
<b>703709</b>	L225 PBC	L225 PBC	CP			6x0,25x124°	EUI Nozzle
<b>703710</b>	L226 PBC	L226 PBC	CP			6x0,265x155°	EUI Nozzle
<b>7037105</b>	L229 PBC	L229 PBC	CP				EUI Nozzle
<b>7037109</b>	L233 PBC	L233 PBC	CP				EUI Nozzle
<b>703711</b>	L234 PBC	L234 PBC	CP			5x0,24x154°	EUI Nozzle
<b>7037112</b>	L240 PBC	L240 PBC	CP				EUI Nozzle
<b>7037113</b>	L242 PBC	L242 PBC	CP				EUI Nozzle
<b>7037114</b>	L322 PBC	L322 PBC	CP			6x0,245x150°	EUI Nozzle
<b>7037115</b>	L325 PBC	L325 PBC	CP			6x0,225x152°	EUI Nozzle
<b>7037116</b>	L357 PBC	L357 PBC	CP				EUI Nozzle
<b>7037118</b>	L405 PBC	L405 PBC	CP			7x0,20x156°	Smart Nozzle
<b>703712</b>	L076 PBD	L076 PBD	CP			6x0,15x154°	2 Springs Nozzle
<b>703713</b>	L078 PBD	L078 PBD	CP			6x0,146x140°	2 Springs Nozzle
<b>703714</b>	L079 PBD	L079 PBD	CP			5x0,18x150°	2 Springs Nozzle
<b>703721</b>	L096 PBD	L096 PBD	CP			6x0,15x155°	CR Nozzle
<b>703722</b>	L097 PBD	L097 PBD	CP			6x0,18x151°	CR Nozzle
<b>703728</b>	L120 PBD	L120 PBD	CP			5x0,16x144°	CR Nozzle
<b>703729</b>	L121 PBD	L121 PBD	CP			6x0,155x150°	CR Nozzle
<b>703733</b>	L133 PBD	L133 PBD	CP			6x0,15x154°	CR Nozzle
<b>703734</b>	L135 PBD	L135 PBD	CP			7x0,13x155°	CR Nozzle
<b>70374</b>	LP004 B	LP004 B	CP			8x0,19x157°	EUI Nozzle
<b>703771</b>	LP051 B	LP051 B				5x0,24x133°	Nozzle
<b>703772</b>	LP052 B	LP052 B				5x0,26x131°	Nozzle
<b>703773</b>	LP053 B	LP053 B				5x0,24x145°	Nozzle
<b>703774</b>	LP054 B	LP054 B				5x0,25x144°	Nozzle
<b>703775</b>	LP055 B	LP055 B				5x0,28x133°	Nozzle
<b>70380</b>	L087 PRD	L087 PRD	CP			5x0,145x145°	CR Nozzle
<b>70382</b>	L136 PRD	L136 PRD	CP			6x0,165x152°	CR Nozzle
<b>703821</b>	L137 PRD	L137 PRD	CP				CR Nozzle
<b>703822</b>	L138 PRD	L138 PRD	CP				CR Nozzle
<b>70383</b>	L157 PRD	L157 PRD	CP				CR Nozzle
<b>703833</b>	L163 PRD	L163 PRD	CP				CR Nozzle
<b>703836</b>	L244 PRD	L244 PRD	CP				CR Nozzle
<b>70384</b>	L274 PRD	L274 PRD	CP				CR Nozzle
<b>70385</b>	L281 PRD	L281 PRD	CP			7x0,125x155°	CR Nozzle

Our Ref.	Stamping	Part Number	CP	DLC	D/A	Technical Data	Description
<b>Delphi</b>							
703855	L340 PRD		CP				CR Nozzle
703856	L341 PRD	H341	CP	DLC			CR Nozzle
703857	L342 PRD	H342	CP	DLC			CR Nozzle
70386	L347 PRD	H347	CP	DLC			CR Nozzle
70387	L363 PRD	L363 PRD	CP				CR Nozzle
703871	L364 PRD	H364	CP	DLC		8x0,12x155°	CR Nozzle
703872	L365 PRD		CP				CR Nozzle
70388	L374 PRD	H374	CP	DLC			CR Nozzle
703881	L375 PRD	H375	CP	DLC			CR Nozzle
70390	L381 PRD	L381 PRD	CP				CR Nozzle
70393	G467	G467	CP	DLC			CR Nozzle
70394	G488	G488	CP	DLC			CR Nozzle
70395	G523	G523	CP	DLC			CR Nozzle
70401C	6801001	RB6801001				2x0,36+2x0,40	Nozzle
70403	6801011	JB6801011				4x0,35x149°	Nozzle
70404	6801012	JB6801012				4x0,27x150°	Nozzle
70405	6801014	JB6801014				3x0,34x147°	Nozzle
70407	6801016	JB6801016				4x0,33x149°	Nozzle
70408	6801017	JB6801017				4x0,34x150°	Nozzle
70409	6801018	JB6801018				4x0,30x150°	Nozzle
70410	6801019	JB6801019				4x0,30x150°	Nozzle
70411	6801022	JB6801022				4x0,30x148°	Nozzle
70413	6801024	JB6801024				4x0,24x154°	Nozzle
70415	6801026	JB6801026				4x0,41x138°	Nozzle
70416	6801027	JB6801027				4x0,29x150°	Nozzle
70419	6801029	JB6801029				4x0,27x147°	Nozzle
70422	6801032	JB6801032				4x0,31x150°	Nozzle
70424	6801034	JB6801034				4x0,37x136°	Nozzle
70425	6801047	JB6801047				4x0,31x150°	Nozzle
704253	6801051	JB6801051				4x0,40x128°	Nozzle
704254	6801052	JB6801052				4x0,30x128°	Nozzle
704254C	6801053	6801053				4x0,25x161°	Nozzle
704255	6801057	JB6801057				4x0,29x140°	Nozzle
704256	6801058	JB6801058				4x0,30x148°	Nozzle
70426	6801060	JB6801060				4x0,34x156°	Nozzle
704261	6801061	JB6801061				4x0,26x157°	Nozzle
70427	6801072	JB6801072				5x0,29x150°	Nozzle
70428	6801075	JB6801075				4x0,38x154°	Nozzle
70430	6801079	JB6801079				4x0,29x156°	Nozzle
70432	6801081	JB6801081				4x0,25x160°	Nozzle
70433	6801082	JB6801082				4x0,34x147°	Nozzle
704334	6801084	JB6801084				4x0,28x143°	Nozzle
704337	6801087	JB6801087				5x0,29x146°	Nozzle
704338	6801088	JB6801088				4x0,30x142°	Nozzle
70434	6801093	JB6801093				4x0,33x147°	Nozzle
704345	6801100	JB6801100				4x0,33x139°	Nozzle
70435	6801104	JB6801104				4x0,32x142°	Nozzle
704356	6801106	JB6801106				4x0,29x149°	Nozzle
704362	6801110	JB6801110				4x0,29x140°	Nozzle
7043621	6801111	JB6801111				4x0,25x145°	Nozzle
7043622	6801112E	JB6801112E				4x0,26x154°	Nozzle
7043628	6801118	JB6801118				4x0,31x154°	Nozzle
7043631	6801121	JB6801121				4x0,29x159°	Nozzle
7043632	6801122	JB6801122				4x0,28x155°	Nozzle

<i>Our Ref.</i>	<i>Stamping</i>	<i>Part Number</i>	<i>CP</i>	<i>DLC</i>	<i>D/A</i>	<i>Technical Data</i>	<i>Description</i>
<b>Delphi</b>							
7043633	6801123	JB6801123				4x0,37x157°	Nozzle
7043639	6801124	JB6801124				4x0,345x157°	Nozzle
7043640	6801127	JB6801127				4x0,39x157°	Nozzle
7043641	6801128	JB6801128				4x0,28x149°	Nozzle
7043644	6801130	JB6801130				4x0,26x153°	Nozzle
7043645	6801131	JB6801131				6x0,28x149°	Nozzle
7043647	6801133	JB6801133				4x0,27x149°	Nozzle
7043648	6801134	JB6801134				5x0,27x154°	Nozzle
704365	6801135	JB6801135				5x0,29x150°	Nozzle
704366	6801148	JB6801148				5x0,29x150°	Nozzle
704367	6801157	JB6801157				4x0,33x145°	Nozzle
7043671	6801158	JB6801158					Nozzle
704368	6801164	JB6801164				5x0,25x150°	Nozzle
7043681	6801165	JB6801165				4x0,31x150°	Nozzle
704368C	6801172	6801172				4x0,25x160°	Nozzle
704369	6801173	JB6801173				4x0,28x150°	Nozzle
7043695	6801174	JB6801174					Nozzle
70437	6801175	JB6801175				4x0,25x146°	Nozzle
70438	6801176	JB6801176				4x0,28x144°	Nozzle
704382	6801180	JB6801180				4x0,26x153°	Nozzle
70439	6809409	JB6809409				3x0,32x136°	Nozzle
70448	6950708	JB6950708				4x0,39x130°	Nozzle
706381C	BDLLA150S 308	5628927				5x0,34x150°	Nozzle
706382C	BDLLA150S 310	5628928				5x0,35x150°	Nozzle
706384C	BDLLA150S 312	5628929				5x0,27x150°	Nozzle
NDL10286	BDL35T 486					3x0,50x35°	Nozzle
NDL10407	BDL160T 6087					6x0,33x160°	Nozzle
NDL10532	BDL140T 6332					6x0,43x140°	Nozzle
NDL20503	BDLL130T 6331					7+1x0,35x130°	Nozzle

<b>Denso</b>							
43080	ND-DN4SD24ND 80	093400-0800					Pintle Nozzle
43090	ND-DN4SDND 90	093400-0900					Pintle Nozzle
43133	ND-DN4SDND 133	093400-1330					Pintle Nozzle
43135	ND-DN4SDND 135	093400-1350					Pintle Nozzle
43177	ND-DN0SDN 177	093400-1770					Pintle Nozzle
43187	ND-DN0SDN 187	093400-2910					Pintle Nozzle
43320	DN15PD 6	093400-5060					Pintle Nozzle
43332	DN20PD 32	093400-5420					Pintle Nozzle
43337	DN0PD 37	093400-5370					Pintle Nozzle
43358	DN0PD 58	093400-5580					Pintle Nozzle
43360	DN0PD 80	093400-5800					Pintle Nozzle
43361	DN0PD 95	093400-5950					Pintle Nozzle
43367	DN15PD 609	093400-6090					Pintle Nozzle
43369	DN0PD 619	093400-6260					Pintle Nozzle
43373	DN0PD 628	093400-6280					Pintle Nozzle
43381	DN4PD 681	093400-6810					Pintle Nozzle
73603	ND-DLLA150S3840ND 52	093400-0520				2x0,38+2x0,40	Nozzle
73605	ND-DLLA150S384ND 57	093400-0570				4x0,38x150°	Nozzle
73610	ND-DLLA150S3840ND 70	093400-0700				2x0,38+2x0,40	Nozzle
73615	ND-DLLA150S3133ND 73	093400-0730				2x0,31+2x0,32	Nozzle
73619	ND-DLLA150S3739ND82	093400-0820				2x0,37+2x0,39x150°	Nozzle
73625	ND-DLLA160S295ND 96	093400-0960				5x0,29x160°	Nozzle
73630	ND-DLLA150S3133ND 97	093400-0970				2x0,31+2x0,33	Nozzle

<i>Our Ref.</i>	<i>Stamping</i>	<i>Part Number</i>	<i>CP</i>	<i>DLC</i>	<i>D/A</i>	<i>Technical Data</i>	<i>Description</i>
<b>73638</b>	ND-DLLA150S325ND 117	093400-1170				5x0,32x150°	Nozzle
<b>73639</b>	ND-DLLA150S414ND 118	093400-1180				2x0,37+2x0,41	Nozzle
<b>73640</b>	ND-DLLA154S324ND 119	093400-1190				4x0,32x154°	Nozzle
<b>73653</b>	ND-DLLA150S315ND 145	093400-1450				5x0,32x150°	Nozzle
<b>736537</b>	ND-DLLA160S295ND 147	093400-1470				5x0,29x160°	Nozzle
<b>736549</b>	ND-DLLA160S295ND 152	093400-1520				5x0,29x160°	Nozzle
<b>73655</b>	ND-DLLA142S344ND 153	093400-1530				4x0,34x142°	Nozzle
<b>73656</b>	ND-DLLA150SND 154	093400-1540				4x0,41x150°	Nozzle
<b>73659</b>	ND-DLLA142S315ND 159	093400-1590				5x0,31x142°	Nozzle
<b>73660</b>	ND-DLLA155SND 160	093400-1600				5x0,34x155°	Nozzle
<b>73670</b>	ND-DLLA160SND 171	093400-1710				5x0,29x160°	Nozzle
<b>73681</b>	ND-DLLA160SND 181	093400-1810				5x0,31x160°	Nozzle
<b>73686</b>	ND-DLLA155SND 199	093400-1991				5x0,30x155°	Nozzle
<b>73687</b>	ND-DLLA150SND 200	093400-2002				6x0,30x150°	Nozzle
<b>73689</b>	ND-DLLA150SND 227	093400-2270				5x0,29x150°	Nozzle
<b>736892</b>	ND-DLLA150SND 228	093400-2282				5x0,29x150°	Nozzle
<b>73691</b>	ND-DLLA150SND 229	093400-2292				5x0,29x150°	Nozzle
<b>73692</b>	ND-DLLA155SND 234	093400-2340				5x0,28x153°	Nozzle
<b>73693</b>	ND-DLLA160SND 243	093400-2431				5x0,33x160°	Nozzle
<b>736932</b>	ND-DLLA158SND 245	093400-2450					Nozzle
<b>73694</b>	ND-DLLA160SND 249	093400-2490				5x0,31x160°	Nozzle
<b>73695</b>	ND-DLLA157SND 250	093400-2500				5x0,31x157°	Nozzle
<b>73697</b>	ND-DLLA155SND 263	093400-2630				5x0,27x155°	Nozzle
<b>73698</b>	ND-DLLA157SND 297	093400-2970				6x0,25x157°	Nozzle
<b>73699</b>	ND-DLLA157SND 314	093400-3140				6x0,21x155°	Nozzle
<b>73703</b>	ND-DLLA160P 3	093400-5030				5x0,29x160°	Nozzle
<b>73709</b>	ND-DLLA150P 9	093400-5090				4x0,31x150°	Nozzle
<b>73716</b>	ND-DLLA155P 16	093400-5160				5x0,26x155°	Nozzle
<b>73724</b>	ND-DLLA150P 24	093400-5240				5x0,26x150°	Nozzle
<b>73725</b>	ND-DLLA160P 25	093400-5250				5x0,28x160°	Nozzle
<b>73735</b>	ND-DLLA150P 35	093400-5350				5x0,27x150°	Nozzle
<b>73750</b>	ND-DLLA160P 50	093400-5500				5x0,29x160°	Nozzle
<b>73759</b>	ND-DLLA150P 59	093400-5590				4x0,31x150°	Nozzle
<b>73761</b>	ND-DLLA150P 61	093400-5611				4x0,29x150°	Nozzle
<b>73763</b>	ND-DLLA152P 69	093400-5690				5x0,29x152°	Nozzle
<b>73765</b>	ND-DLLA150P 77	093400-5770				5x0,30x150°	Nozzle
<b>737652</b>	ND-DLLA160P 79	093400-5790				5x0,275x160°	Nozzle
<b>73769</b>	ND-DLLA148P 99	093400-5990				7x0,23x148°	Nozzle
<b>73782</b>	ND-DLLA150P 602	093400-6020				5x0,26x150°	Nozzle
<b>73795</b>	ND-DLLA158P 615	093400-6150				7x0,25x158°	Nozzle
<b>737956</b>	ND-DLLA158P 616	093400-6160	CP			7x0,22x158°	Nozzle
<b>73796</b>	ND-DLLA158P 617	093400-6170	CP			7x0,255x158°	Nozzle
<b>737965</b>	ND-DLLA155P 631	093400-6310				4x0,28x155°	Nozzle
<b>737968</b>	ND-DLLA155P 638	093400-6380				5x0,24x155°	Nozzle
<b>73797</b>	ND-DLLA145P 639	093400-6390	CP			6x0,23x145°	Nozzle
<b>737979</b>	ND-DLLA154P 642	093400-6420				5x0,23x154°	Nozzle
<b>73798</b>	ND-DLLA140P 643	093400-6430				5x0,29x140°	Nozzle
<b>73799</b>	ND-DLLA150P 644	093400-6440				5x0,26x147°	Nozzle
<b>73805</b>	ND-DLLA148P 662	093400-6620	CP			7x0,215x148°	Nozzle
<b>73807</b>	ND-DLLA150P 671	093400-6710				5x0,27x150°	Nozzle
<b>73809</b>	ND-DLLA154P 674	093400-6740				5x0,26x154°	Nozzle
<b>73810</b>	ND-DLLA155P 683	093400-6830				6x0,265x155°	CR Nozzle
<b>738101</b>	ND-DLLA145P 684	093400-6840					2 Springs Nozzle
<b>738103</b>	ND-DLLA144P 690	093400-6900					CR Nozzle

Our Ref.	Stamping	Part Number	CP	DLC	D/A	Technical Data	Description
<b>738105</b>	ND-DLLA146P 692	093400-6920	CP			5x0,21x146°	2 Springs Nozzle
<b>738108</b>	ND-DLLA149P 703	093400-7030	CP	DLC		6x0,205x149°	CR Nozzle
<b>738109</b>	ND-DLLA144P 705	093400-7050	CP			5x0,22x144°	Nozzle
<b>73811</b>	ND-DLLA155P 706	093400-7060	CP	DLC		6x0,22x155°	CR Nozzle
<b>738121</b>	ND-DLLA154P 717	093400-7170	CP	DLC		5x0,215x154°	CR Nozzle
<b>73815</b>	ND-DLLA144P 720	093400-7200	CP	DLC		7x0,185x144°	CR Nozzle
<b>73817</b>	ND-DLLA147P 747	093400-7470	CP	DLC		6x0,14x147°	CR Nozzle
<b>73818</b>	ND-DLLA145P 748	093400-7480	CP	DLC		6x0,22x145°	CR Nozzle
<b>738189</b>	ND-DLLA147P 752	093400-7520	CP	DLC		6x0,125x147°	CR Nozzle
<b>73819</b>	ND-DLLA155P 753	093400-7530	CP	DLC		7x0,155x155°	CR Nozzle
<b>73821</b>	ND-DLLA143P 761	093400-7610				6x0,285x143°	CR Nozzle
<b>73822</b>	ND-DLLA147P 762	093400-7620	CP	DLC		6x0,21x147°	CR Nozzle
<b>73823</b>	ND-DLLA148P 763	093400-7630	CP	DLC		7x0,185x148°	CR Nozzle
<b>73824</b>	ND-DLLA148P 764	093400-7640	CP	DLC		7x0,203x148°	CR Nozzle
<b>738241</b>	ND-DLLA148P 765	093400-7650	CP	DLC		6x0,185x148°	CR Nozzle
<b>738244</b>	ND-DLLA146P 768	093400-7680	CP	DLC		6x0,19x146°	2 Springs Nozzle
<b>738251</b>	ND-DLLA147P 788	093400-7880	CP	DLC		6x0,15x147°	CR Nozzle
<b>73829</b>	ND-DLLA142P 793	093400-7930	CP	DLC		6x0,235x142°	CR Nozzle
<b>73830</b>	ND-DLLA152P 798	093400-7980					CR Nozzle
<b>73831</b>	ND-DLLA156P 799	093400-7990	CP	DLC		6x0,18x156°	CR Nozzle
<b>73832</b>	ND-DLLA148P 800	093400-8000	CP	DLC		8x0,16x148°	CR Nozzle
<b>73835</b>	ND-DLLA152P 805	093400-8050	CP	DLC		6x0,14x152°	CR Nozzle
<b>738371</b>	ND-DLLA155P 807	093400-8070	CP	DLC		7x0,145x155°	CR Nozzle
<b>73838</b>	ND-DLLA133P 814	093400-8140	CP	DLC		6x0,195x133°	CR Nozzle
<b>73839</b>	ND-DLLA150P 815	093400-8150	CP	DLC		6x0,12x150°	CR Nozzle
<b>738395</b>	ND-DLLA148P 816	093400-8160	CP	DLC		7x0,155x148°	CR Nozzle
<b>738401</b>	ND-DLLA148P 817	093400-8170	CP	DLC		6x0,13x148°	CR Nozzle
<b>738402</b>	ND-DLLA148P 820	093400-8200	CP	DLC		7x0,19x148°	CR Nozzle
<b>738403</b>	ND-DLLA148P 821	093400-8210	CP	DLC		7x0,21x148°	CR Nozzle
<b>738404</b>	ND-DLLA148P 824	093400-8240	CP	DLC		7x0,14x148°	CR Nozzle
<b>738405</b>	ND-DLLA148P 826	093400-8260	CP	DLC		7x0,16x148°	CR Nozzle
<b>738406</b>	ND-DLLA148P 828	093400-8280	CP	DLC		7x0,22x148°	CR Nozzle
<b>738407</b>	ND-DLLA144P 830	093400-8300	CP			5x0,21x144°	2 Springs Nozzle
<b>738409</b>	ND-DLLA158P 834	093400-8340	CP	DLC		8x0,22x158°	CR Nozzle
<b>73841</b>	ND-DLLA150P 835	093400-8350	CP	DLC		6x0,205x150°	CR Nozzle
<b>738417</b>	ND-DLLA155P 840	093400-8400	CP	DLC		6x0,165x155°	CR Nozzle
<b>73842</b>	ND-DLLA155P 842	093400-8420	CP	DLC		6x0,195x155°	CR Nozzle
<b>738431</b>	ND-DLLA158P 844	093400-8440	CP	DLC		7x0,12x158°	CR Nozzle
<b>73844</b>	ND-DLLA155P 848	093400-8480	CP	DLC		6x0,175x155°	CR Nozzle
<b>738450</b>	ND-DLLA139P 851	093400-8510	CP	DLC		6x0,175x139°	CR Nozzle
<b>738451</b>	ND-DLLA142P 852	093400-8520	CP	DLC		6x0,25x142°	CR Nozzle
<b>7384541</b>	ND-DLLA158P 854	970950-0547	CP	DLC		7x0,16x158°	CR Nozzle
<b>73846</b>	ND-DLLA157P 855	093400-8550	CP	DLC		6x0,155x157°	CR Nozzle
<b>73847</b>	ND-DLLA155P 856	093400-8560	CP	DLC		7x0,19x155°	CR Nozzle
<b>73849</b>	ND-DLLA150P 861	093400-8610				5x0,25x150°	Nozzle
<b>7384911</b>	ND-DLLA152P 862	093400-8620	CP	DLC		6x0,15x152°	CR Nozzle
<b>7384931</b>	ND-DLLA155P 863	093400-8630	CP	DLC		8x0,14x155°	CR Nozzle
<b>7384941</b>	ND-DLLA145P 864	093400-8640	CP	DLC		6x0,145x145°	CR Nozzle
<b>7384951</b>	ND-DLLA152P 865	093400-8650	CP	DLC		8x0,21x152°	CR Nozzle
<b>738496</b>	ND-DLLA150P 866	093400-8660	CP	DLC		6x0,18x150°	CR Nozzle
<b>7384971</b>	ND-DLLA145P 870	093400-8700	CP	DLC		6x0,16x145°	CR Nozzle
<b>738498</b>	ND-DLLA148P 872	093400-8720	CP	DLC		8x0,16x148°	CR Nozzle
<b>7384991</b>	ND-DLLA145P 875	093400-8750	CP	DLC		6x0,17x145°	CR Nozzle
<b>7384992</b>	ND-DLLA155P 876	093400-8760	CP	DLC		9x0,105x155°	CR Nozzle

<i>Our Ref.</i>	<i>Stamping</i>	<i>Part Number</i>	<i>CP</i>	<i>DLC</i>	<i>D/A</i>	<i>Technical Data</i>	<i>Description</i>
<b>7384999</b>	ND-DLLA155P 880	093400-8800	CP	DLC		8x0,13x155°	CR Nozzle
<b>73850</b>	ND-DLLA154P 881	093400-8810	CP	DLC		6x0,135x154°	CR Nozzle
<b>738510</b>	ND-DLLA153P 884	093400-8840	CP	DLC		7x0,12x153°	CR Nozzle
<b>738511</b>	ND-DLLA153P 885	093400-8850	CP	DLC		7x0,15x153°	CR Nozzle
<b>73852</b>	ND-DLLA139P 887	093400-8870	CP	DLC		6x0,185x139°	CR Nozzle
<b>73853</b>	ND-DLLA125P 889	093400-8890	CP	DLC		6x0,21x125°	CR Nozzle
<b>73854</b>	ND-DLLA129P 890	093400-8900	CP	DLC		6x0,19x129°	CR Nozzle
<b>738551</b>	ND-DLLA156P 905	093400-9050	CP	DLC		7x0,175x156°	CR Nozzle
<b>73856</b>	ND-DLLA150P 906	093400-9060	CP	DLC		6x0,20x150°	CR Nozzle
<b>738565</b>	ND-DLLA158P 909	093400-9090	CP	DLC		8x0,25x158°	CR Nozzle
<b>738571</b>	ND-DLLA148P 915	093400-9150	CP	DLC		6x0,215x148°	CR Nozzle
<b>7385713</b>	ND-DLLA152P 917	093400-9170	CP	DLC		8x0,115x152°	CR Nozzle
<b>7385714</b>	ND-DLLA138P 919	093400-9190	CP	DLC		6x0,24x138°	CR Nozzle
<b>7385715</b>	ND-DLLA148P 924	093400-9240	CP	DLC		7x0,13x148°	CR Nozzle
<b>7385717</b>	ND-DLLA139P 925	093400-9250	CP	DLC		6x0,165x139°	CR Nozzle
<b>738581</b>	ND-DLLA150P 927	093400-9270	CP	DLC		8x0,175x150°	CR Nozzle
<b>738582</b>	ND-DLLA152P 929	093400-9290	CP	DLC		8x0,22x152°	CR Nozzle
<b>7385831</b>	ND-DLLA148P 932	093400-9320	CP	DLC		8x0,13x148°	CR Nozzle
<b>738589</b>	ND-DLLA155P 939	093400-9390	CP	DLC		8x0,10x155°	CR Nozzle
<b>738590</b>	ND-DLLA155P 941	093400-9410	CP	DLC		6x0,145x155°	CR Nozzle
<b>738591</b>	ND-DLLA127P 944	093400-9440	CP	DLC		5x0,18x127°	CR Nozzle
<b>738592</b>	ND-DLLA127P 945	093400-9450	CP	DLC		5x0,16x127°	CR Nozzle
<b>738593</b>	ND-DLLA152P 947	093400-9470	CP	DLC		8x0,155x152°	CR Nozzle
<b>7385951</b>	ND-DLLA151P 955	093400-9550	CP	DLC		7x0,135x151°	CR Nozzle
<b>738605</b>	ND-DLLA155P 960	093400-9600	CP	DLC		9x0,10x155°	CR Nozzle
<b>7386091</b>	ND-DLLA155P 964	093400-9640	CP	DLC		7x0,18x155°	CR Nozzle
<b>738611</b>	ND-DLLA155P 965	093400-9650	CP	DLC		8x0,21x155°	CR Nozzle
<b>738621</b>	ND-DLLA150P 966	093400-9660	CP	DLC		6x0,135x150°	CR Nozzle
<b>73865</b>	ND-DLLA155P 970	093400-9700	CP	DLC		9x0,11x155°	CR Nozzle
<b>73866</b>	ND-DLLA155P 971	093400-9710	CP	DLC		9x0,10x155°	CR Nozzle
<b>738671</b>	ND-DLLA153P 977	093400-9770	CP	DLC		7x0,17x153°	CR Nozzle
<b>73870</b>	ND-DLLA152P 980	093400-9800	CP	DLC		6x0,15x152°	CR Nozzle
<b>73871</b>	ND-DLLA152P 981	093400-9810	CP	DLC		6x0,145x152°	CR Nozzle
<b>738712</b>	ND-DLLA129P 983	093400-9830	CP	DLC		6x0,19x129°	CR Nozzle
<b>738713</b>	ND-DLLA158P 984	093400-9840	CP	DLC		7x0,17x158°	CR Nozzle
<b>738714</b>	ND-DLLA155P 985	093400-9850	CP	DLC		8x0,13x155°	CR Nozzle
<b>73872</b>	ND-DLLA152P 989	093400-9890	CP	DLC			CR Nozzle
<b>73873</b>	ND-DLLA150P 991	093400-9910	CP	DLC		6x0,23x150°	CR Nozzle
<b>73875</b>	ND-DLLA150P 1023	093400-1023	CP	DLC		6x0,11x150°	CR Nozzle
<b>73876</b>	ND-DLLA145P 1024	093400-1024	CP	DLC		6x0,145x145°	CR Nozzle
<b>738761</b>	ND-DLLA155P 1025	093400-1025	CP	DLC		8x0,13x155°	CR Nozzle
<b>7387615</b>	ND-DLLA150P 1026	093400-1026	CP	DLC		6x0,13x150°	CR Nozzle
<b>7387616</b>	ND-DLLA155P 1027	093400-1027	CP	DLC		9x0,11x155°	CR Nozzle
<b>738762</b>	ND-DLLA155P 1028	093400-1028	CP	DLC		9x0,105x155°	CR Nozzle
<b>7387629</b>	ND-DLLA155P 1030	093400-1030	CP	DLC		7x0,145x155°	CR Nozzle
<b>738763</b>	ND-DLLA145P 1031	093400-1031	CP	DLC		7x0,15x145°	CR Nozzle
<b>738764</b>	ND-DLLA149P 1036	093400-1036	CP	DLC		7x0,20x149°	CR Nozzle
<b>738766</b>	ND-DLLA152P 1040	093400-1040	CP	DLC		8x0,12x152°	CR Nozzle
<b>738768</b>	ND-DLLA155P 1044	093400-1044	CP	DLC		6x0,165x155°	CR Nozzle
<b>73877</b>	ND-DLLA145P 1049	093400-1049	CP	DLC		8x0,215x145°	CR Nozzle
<b>73881</b>	ND-DLLA150P 1052	093400-1052	CP	DLC		8x0,205x150°	CR Nozzle
<b>738813</b>	ND-DLLA150P 1054	093400-1054	CP	DLC		8x0,155x150°	CR Nozzle
<b>738817</b>	ND-DLLA150P 1059	093400-1059	CP	DLC		6x0,18x150°	CR Nozzle
<b>73882</b>	ND-DLLA155P 1062	093400-1062	CP	DLC		8x0,13x155°	CR Nozzle

Our Ref.	Stamping	Part Number	CP	DLC	D/A	Technical Data	Description
<b>Denso</b>							
73887	ND-DLLA152P 1072	093400-1072	CP	DLC		8x0,125x150°	CR Nozzle
73890	ND-DLLA155P 1090	093400-1090	CP	DLC		7x0,185x155°	CR Nozzle
73892	ND-DLLA158P 1092	093400-1092	CP	DLC		7x0,12x158°	CR Nozzle
73896	ND-DLLA158P 1096	093400-1096	CP	DLC		7x0,17x158°	CR Nozzle
738961	ND-DLLA152P 1097	093400-1097	CP	DLC		8x0,21x152°	CR Nozzle
73905	ND-DLLA152P 1115	093400-1115	CP	DLC		8x0,115x152°	CR Nozzle
73959	G3S1		CP	DLC		Ø3.5 - 10x0,12x153°	CR Nozzle
73960	G3S3		CP	DLC		Ø3.5 - 8x0,12x153°	CR Nozzle
739601	G3S4		CP	DLC		Ø3.5 - 8x0,125x153°	CR Nozzle
73961	G3S6		CP	DLC		Ø3.5 - 8x0,13x153°	CR Nozzle
73962	G3S7		CP	DLC		Ø3.5 - 6x0,12x148°	CR Nozzle
739621	G3S8		CP	DLC		Ø3.5 - 8x0,12x159°	CR Nozzle
73963	G3S10		CP	DLC		Ø3.5	CR Nozzle
739632	G3S12		CP	DLC		Ø3.5	CR Nozzle
73964	G3S16		CP	DLC		Ø3.5	CR Nozzle
73965	G3S17		CP	DLC		Ø3.5 - 6x0,19x125°	CR Nozzle
73966	G3S22		CP	DLC		Ø3.5 - 5x0,16x134°	CR Nozzle
739667	G3S29		CP	DLC		Ø3.5 - 8x0,11x152°	CR Nozzle
73967	G3S32		CP	DLC		Ø3.5 - 8x0,13x145°	CR Nozzle
73968	G3S33		CP	DLC		Ø3.5 - 6x0,15x145°	CR Nozzle
739685	G3S41		CP	DLC		Ø3.5 - 7x0,31x152°	CR Nozzle
73969	G3S45		CP	DLC		Ø3.5 - 7x0,155x144°	CR Nozzle
739691	G3S46		CP	DLC		Ø3.5 - 8x0,12x151°	CR Nozzle
739692	G3S47		CP	DLC		Ø3.5 - 8x0,115x152°	CR Nozzle
739695	G3S48		CP	DLC		Ø3.5 - 7x0,125x154°	CR Nozzle
73970	G3S49		CP	DLC		Ø3.5 - 7x0,145x146°	CR Nozzle
739701	G3S50		CP	DLC		Ø3.5 - 7x0,15x145°	CR Nozzle
739702	G3S51		CP	DLC		Ø3.5 - 8x0,155x152°	CR Nozzle
739703	G3S52		CP	DLC		Ø3.5 - 8x0,13x148°	CR Nozzle
739704	G3S53		CP	DLC		Ø3.5 - 8x0,145x146°	CR Nozzle
73972	G3S58		CP	DLC		Ø3.5	CR Nozzle
73973	G3S60		CP	DLC		Ø3.5 - 8x0,14x154°	CR Nozzle
73974	G3S62		CP	DLC		Ø3.5 - 6x0,1x150°	CR Nozzle
739741	G3S63		CP	DLC		Ø3.5 - 7x0,12x145°	CR Nozzle
73975	G3S69		CP	DLC		Ø3.5 - 7x0,185x148°	CR Nozzle
73976	G3S72		CP	DLC		Ø3.5	CR Nozzle
73977	G3S77		CP	DLC		Ø3.5 - 8x0,13x149°	CR Nozzle
73979	G3S79		CP	DLC		Ø3.5	CR Nozzle
73981	G3S81		CP	DLC		Ø3.5	CR Nozzle
73983	G3S87		CP	DLC		Ø3.5	CR Nozzle
73990	G3S112		CP	DLC		Ø3.5	CR Nozzle
73995	G3S126		CP	DLC		Ø3.5 - 8x0,11x150°	CR Nozzle
73996	G3S132		CP	DLC		Ø3.5 - 9x0,16x154°	CR Nozzle
73G411	G4S011		CP	DLC			CR Nozzle
73G411K	G4S011	KIT	CP	DLC			CR Nozzle
73G412	G4S012		CP	DLC		10x0,1x156°	CR Nozzle
73G412K	G4S012	KIT	CP	DLC			CR Nozzle
73P203	G2P3		CP	DLC			Piezo Nozzle
73P316	G3P016		CP	DLC			Piezo Nozzle
73P317	G3P017		CP	DLC			Piezo Nozzle

## Detroit Diesel

59509	522 8436	Tip 35,40,45,6S8					Nozzle
59513	522 8554	Tip HV7,8,9 S70,80,90					Nozzle

Our Ref.	Stamping	Part Number	CP	DLC	D/A	Technical Data	Description
----------	----------	-------------	----	-----	-----	----------------	-------------

## Detroit Diesel

59515	522 9026	Tip N55,60,65 C55,60,65					Nozzle
59517	522 9030	Tip N65 B65 5A50,55,60					Nozzle
59519	522 9034	Tip N35,40,45,50 C40,45					Nozzle
59521	522 9184	Tip F70....105					Nozzle
59523	522 9192	Tip N70,75,80 C65 M60					Nozzle
59525	522 9256	Tip M95 N80,90					Nozzle
59529	522 9636	Tip 7A65,70,75 7C70,75					Nozzle
59531	522 9642	Tip 7A50,55,60					Nozzle
59533	522 9806	Tip FB/FC70,75,80,90					Nozzle

## Doowon

76233	KP-DLLA160SK 881					(2x0,36+2x0,34)x160°	Nozzle
76235	KP-DLLA150SK 985					5x0,345x150°	Nozzle
76236	KP-DLLA150SK 985A					5x0,34x150°	Nozzle
76256	KP-DLLA155SM 066	105029-1320				5x0,34x155°	Nozzle
76257	KP-DLLA155SM 067	105029-1330				5x0,30x155°	Nozzle
76272	KP-DLLA150SN 082	105029-1370				4x0,26x150°	Nozzle
76273	KP-DLLA155SN 083					5x0,30x155°	Nozzle
76274	KP-DLLA160SN 084					5x0,32x160°	Nozzle
76284	KP-DLLA160SN 644	105029-1190				5x0,29x160°	Nozzle
76301	KP-DLLA150SN 902	105029-1280				5x0,31x150°	Nozzle
763014	KP-DLLA156SN 921	105029-1290				6x0,29x156°	Nozzle
76307	KP-DLLA155PK 107					4x0,34x155°	Nozzle
76308	KP-DLLA160PN 070					5x0,28x160°	Nozzle
76310	KP-DLLA160PN 141	see 73441				5x0,30x160°	Nozzle
76312	KP-DLLA155PN 179	105029-2000				4x0,31x155°	Nozzle
76313	KP-DLLA155PN 200	105029-2020				4x0,28x155°	Nozzle
763132	KP-DLLA155PN 202	105029-2030				5x0,26x155°	Nozzle
763133	KP-DLLA153PN 203A	105029-203A				5x0,26x153°	Nozzle

## F&M

76804	D1LMK 140/4	9431 362 350				4x0,42x140°	Nozzle
76821	D1LMK 150/21	9431 362 378				3x0,29x150°	Nozzle
76839	D1LMK 150/39	9431 362 390				3x0,31x150°	Nozzle
76842	D1LMK 150/42	9431 362 414				4x0,33x150°	Nozzle
76854C	D1LMK 150/54					3x0,31x150°	Nozzle

## Fiat - Iveco

72000	DLL145S 4F					4x0,27x145°	Nozzle
72005	DLL145S 19F					4x0,22x145°	Nozzle
72006	DLL145S 20F					4x0,28x145°	Nozzle
72007L	DLL145S 24F					4x0,27x145°	Nozzle
72011L	DLL160S 30F					4x0,33x160°	Nozzle
72012L	DLL145S 31F					4x0,29x145°	Nozzle
72013L	DLL140S 33F					4x0,35x140°	Nozzle
72014	DLL145S 34F					4x0,30x145°	Nozzle
72015	DLL145S 35F					4x0,25x145°	Nozzle
72016	DLL145S 36F					4x0,29x145°	Nozzle
72017L	DLL140S 37F					4x0,33x140°	Nozzle
72018L	DLL160S 38F					4x0,33x160°	Nozzle
72019L	DLL140S 39F					4x0,32x140°	Nozzle
72020	DLL160S 40F					4x0,30x160°	Nozzle
72021L	DLL145S 43F					4x0,30x145°	Nozzle
72023L	DLL145S 50F					4x0,29x145°	Nozzle

Our Ref.	Stamping	Part Number	CP	DLC	D/A	Technical Data	Description
----------	----------	-------------	----	-----	-----	----------------	-------------

## Fiat - Iveco

72024	DLL150S 51F					4x0,31x150°	Nozzle
72025L	DLL160S 52F					4x0,36x160°	Nozzle
72026	DLL145S 54F					4x0,28x145°	Nozzle
72027	DLL145S 55F					4x0,28x145°	Nozzle
72028L	DLL140S 56F					3x0,44x140°	Nozzle
72029L	DLL145S 60F					4x0,33x145°	Nozzle
72030L	DLL160S 62F					4x0,37x160°	Nozzle
72031L	DLL140S 64F					3x0,36x140°	Nozzle
72032L	DLL160S 65F					4x0,38x160°	Nozzle
72033	DLL150S 67F					4x0,41x150°	Nozzle
72034	DLL150S 68F					4x0,33x150°	Nozzle
72035	DLL145S 69F					4x0,33x145°	Nozzle
72036L	DLL140S 70F					3x0,37x140°	Nozzle
72037	DLL150S 71F					4x0,34x150°	Nozzle
72038	DLL150S 72F					4x0,42x150°	Nozzle
72039	DLL145S 73F					4x0,35x145°	Nozzle
72040	DLL150S 74F					4x0,40x150°	Nozzle
72041L	DLL140S 75F					3x0,36x140°	Nozzle
72042	DLL150S 76F					4x0,36x150°	Nozzle
72043L	DLL140S 77F					3x0,45x140°	Nozzle
72044	DLL150S 78F					4x0,33x150°	Nozzle
72056	DLL145S 73W					4x0,35x145°	Nozzle
72057	DLL150S 79W					4x0,48x150°	Nozzle
72058L	DLL139S 80WS					4x0,42x139°	Nozzle
72059L	DLL139S 81WS					4x0,40x139°	Nozzle
72060C	DLL124S 500W					4x0,31x124°	Nozzle
72061C	DLL136S 501W					3x0,36x136°	Nozzle
72070CL	DLL160A 570W					4x0,29x160°	Nozzle
72080	DLL150S 600W					4x0,36x150°	Nozzle

## Ford-Navistar

441005	Nozzle Assy. BC-BE	DT466E/I530E					HEUI Nozzle
441006	Nozzle Assy. BG-BJ	DT466E/I530E					HEUI Nozzle
441007	Nozzle Assy. AA/B/C/D/E/	T444E					HEUI Nozzle
441015	Nozzle Assy. BB	DT466E/I530E					HEUI Nozzle
441016	Nozzle Assy. BI	DT466E/I530E					HEUI Nozzle
441025	Nozzle Assy. BA	DT466E/I530E					HEUI Nozzle
441026	Nozzle Assy. BN	DT466E/I530E					HEUI Nozzle
441035	Nozzle Assy. BD	DT466E/I530E					HEUI Nozzle
441036	Nozzle Assy. BP	DT466E/I530E					HEUI Nozzle
441045	Nozzle Assy. BF	DT466E/I530E					HEUI Nozzle
7641005	BC - BE	Navistar DT466E/I530E	CP			5 holes x0,225	HEUI Nozzle
7641006	BG - BJ	Navistar DT466E/I530E	CP			6 holes x0,19	HEUI Nozzle
7641007	AA-AB-AC-AD-AE-AF	Navistar T444E	CP			7 holes x0,17	HEUI Nozzle
7641015	BB	Navistar DT466E/I530E	CP			5 holes x0,22	HEUI Nozzle
7641016	BI	Navistar DT466E/I530E	CP			6 holes x0,175	HEUI Nozzle
7641025	BA	Navistar DT466E/I530E	CP			5 holes x0,25	HEUI Nozzle
7641026	BN	Navistar DT466E/I530E	CP			6 holes x0,195	HEUI Nozzle
7641035	BD	Navistar DT466E/I530E	CP			5 holes x0,28	HEUI Nozzle
7641036	BP	Navistar DT466E/I530E	CP			6 holes x0,17	HEUI Nozzle
7641045	BF	Navistar DT466E/I530E	CP			5 holes x0,23	HEUI Nozzle

## GMT

NFT22030	SF152CUB830	1Q547302/1Q529552				8x0,30x152°	Nozzle
----------	-------------	-------------------	--	--	--	-------------	--------

Our Ref.	Stamping	Part Number	CP	DLC	D/A	Technical Data	Description
----------	----------	-------------	----	-----	-----	----------------	-------------

## GMT

NFT22035	SF152CUB835	1Q547303/1Q529552				8x0,35x152°	Nozzle
NFT22040	SF152CUB840	1Q529551/1Q529552				8x0,40x152°	Nozzle
NFT22045	SF152CUB845	1Q559083/1Q529552				8x0,45x152°	Nozzle
NFT23000	SF152FGM830	1Q313772/1P249415				8x0,30x152°	Nozzle
NFT23003	SF152FGM835	1Q313771/1P249415				8x0,35x152°	Nozzle
NFT23005	SF152FGM835-3G	1Q507048/1P249415				8x0,35x152°	Nozzle
NFT23057	SF157T11133/740AB					7x0,40x157°	Nozzle
NFT23070	12798-GMT-01/55	1114300270				7x0,40x157°	Nozzle
NFT42201	SFF146FC1055FGM	1R219146/1P218150				10x0,55x146°	Nozzle
NFT50600	SF534275-600	1Q534275/1Q523687				1x4,5	Nozzle
NFT55100	SF0 550/11	1R510453/1P507030				1x4,5	Nozzle
NFT55110	SF0 550/13	1R523686/1Q523687				1x4,5	Nozzle

## HiMSEN

NHM1720	H17FV2					10x0,30x134°	Nozzle
NHM2160	H21FV1-5FBM	60°				10x0,32x148°	Nozzle
NHM2190	H21FV1-9FET1	90°				10x0,32x148°	Nozzle
NHM2533	H25FV1					10x0,38x155°	Nozzle
NHM3240	H32FV1					12x0,52x157°	Nozzle
NHM3241	H32FV1					12x0,52x157°	Nozzle
NHM3242	H32FV2					12x0,53x153°	Nozzle

## Lucas-Bryce

41437	P1S4S 437	5643190					Pintle Nozzle
70450	HL140J29D 845 P2	5680568				4x0,29x140°	Nozzle
70451	HL150J22D 828 P2	5680567				4x0,22x150°	Nozzle
70460	L001CTA	L001CTA				5x0,25x140°	Nozzle
70500	HL120S20B 249 P3					2x0,20x120°	Nozzle
70501	HL120S27D 541	5621080				4x0,27x120°	Nozzle
705015	HL120S31E940P3	9170-006D				5x0,31x120°	Nozzle
70502	HL127S36D 662 P3	5680420				4x0,36x127°	Nozzle
70503	HL130S25D 182 P2					4x0,25x130°	Nozzle
70504	HL130S26C 175 P3	5680402				3x0,26x130°	Nozzle
70505	HL130S28C 209 P3					3x0,28x130°	Nozzle
70508	HL134S25D 656 P2					4x0,25x134°	Nozzle
70509	HL135S35C 247					3x0,35x135°	Nozzle
70510	HL140S24D 397 P3	5680406				4x0,24x140°	Nozzle
70511	HL140S25C 544	5621295				3x0,25x140°	Nozzle
70512	HL140S25D 693 P2	5680564				4x0,25x140°	Nozzle
70513	HL140S25C 761	5680446				3x0,25x140°	Nozzle
70514	HL140S25D 881 P2	5680572				4x0,25x140°	Nozzle
70515	HL140S28C 545 P3					3x0,28x140°	Nozzle
70516	HL140S28D 693 P2	5680566				4x0,28x140°	Nozzle
70517	HL140S29D 502 P2					4x0,29x140°	Nozzle
70518	HL140S30D P3					4x0,30x140°	Nozzle
70519	HL141S30D 811 P2	5680451				4x0,30x141°	Nozzle
70520	HL142S32D 525 P2	5680455				4x0,32x142°	Nozzle
70521	HL150S25D 450 P2	5621120				4x0,25x150°	Nozzle
70522	HL150S26D 502 P2					4x0,26x150°	Nozzle
70524	HL150S27D 448	5620960				4x0,27x150°	Nozzle
70525	HL150S27D 548 P2	5621510				4x0,27x150°	Nozzle
70526	HL150S27D 553	5620960				4x0,27x150°	Nozzle
70528	HL150S30C 547					3x0,30x150°	Nozzle
70530	HL160S25D 379 A	5620855				4x0,25x160°	Nozzle

Our Ref.	Stamping	Part Number	CP	DLC	D/A	Technical Data	Description
----------	----------	-------------	----	-----	-----	----------------	-------------

## Lucas-Bryce

70531	HL160S25D 451	5621206				4x0,27x160°	Nozzle
70532	HL160S28D 752					4x0,28x160°	Nozzle
70533	HL176S27D 525 P2	5621243				4x0,27x140°	Nozzle
70534	HL176S30D 525 P2	5680403				4x0,30x140°	Nozzle
NBR10003	H0T60A823P8					1x0,60	Nozzle
NBR10167	H140T43F529					6x0,43x140°	Nozzle
NBR10242	H145T45H532P6					8x0,45x145°	Nozzle
NBR10314	H150T40L814P4	123x1129					Nozzle
NBR10350	H155T30H837P4					8x0,32x155°	Nozzle
NBR10352	H155T30H1101P4					8x0,30x155°	Nozzle
NBR10355	H155T34HP5					8x0,34x155°	Nozzle
NBR10402	H160T33FP6					6x0,33x160°	Nozzle
NBR10419	H160T36H696P4					8x0,36x160°	Nozzle
NBR10422	H160T37K904AP7	223 10232				9x0,375x160°	Nozzle
NBR10432	H160T40E464P4					5x0,40x160°	Nozzle
NBR10447	H160T40F576					6x0,40x160°	Nozzle
NBR10476	H160T40F464P3					6x0,40x160°	Nozzle
NBR10477	H160T45F464P4					6x0,45x160°	Nozzle
NBR20103	HL130T35H418P6					7+1x0,35x130°	Nozzle
NBR20114	HL132T37H200P5					8x0,37x132°	Nozzle
NBR20125	HL140T45F200P3					6x0,45x140°	Nozzle
NBR20128	HL140T48F200P4					6x0,48x140°	Nozzle
NBR20135	HL145T45H775P5					8x0,45x145°	Nozzle
NBR20149	HL150T35K200P6					9x0,35x150°	Nozzle
NBR20154	HL150T35L759P4					5+5x0,35x150°	Nozzle
NBR20158	HL150T38K775P4					9x0,38x150°	Nozzle
NBR20159	HL150T38K785P4					9x0,38x150°	Nozzle
NBR201591	HL150T40K718P5					9x0,40x150°	Nozzle
NBR201592	HL150T40K785P4					9x0,40x150°	Nozzle
NBR201598	HL150T38L703P8					10x0,38x150°	Nozzle
NBR20160	HL150T38L748P8					10x0,38x150°	Nozzle
NBR20182	HL150T44H718P5					8x0,44x150°	Nozzle
NBR20184	HL150T44H795P5					8x0,44x150°	Nozzle
NBR20188	HL150T50G200P4					7x0,50x150°	Nozzle
NBR20195	HL155T46K880P4					9x0,46x155°	Nozzle
NBR45344	HL150V100L744P12					10x1,00x150°	Nozzle
NBR45400	HL153V90L900P12					10x0,90x153°	Nozzle
NBR50000	HOU110A353P7					1x1,0x0°	Nozzle
NBR51000	ABC12VDZC					9x0,40x150°	Nozzle

## Lucas-Simms

70570	NL 141	BDLL150S 6571				4x0,27x150°	Nozzle
70572	NL 179	BDLL140S 6423				4x0,29x140°	Nozzle

## MaK

NMK15112	A1/2	280 220 014				10x0,31x140°	Nozzle
NMK15114	A1/4					12x0,34x150°	Nozzle
NMK17220	A2/2					12x0,30x140°	Nozzle
NMK18035	A3/5					12x0,33x140°	Nozzle
NMK21410	B4/1					10x0,39x140°	Nozzle
NMK30420	C1/1	DLZ150VV-C3245033				12x0,40x150°	Nozzle
NMK30421	C2/1	DLF150VV-C3440100				12x0,40x150°	Nozzle
NMK30422	C2/2	DLF150VV-C3440100				12x0,38x150°	Nozzle
NMK67200	D2/2	210 220 633				10x0,43x140°	Nozzle

Our Ref.	Stamping	Part Number	CP	DLC	D/A	Technical Data	Description
----------	----------	-------------	----	-----	-----	----------------	-------------

## MaK

NMK67420	D4/2	210 220 647				10x0,43x140°	Nozzle
----------	------	-------------	--	--	--	--------------	--------

## Man

NMA62456	2456 3711	8514910 IMO-2456				9x0,26x141°	Nozzle
----------	-----------	------------------	--	--	--	-------------	--------

## Motorpal

74002	DOP150S 335-4359					3x0,35x150°	Nozzle
740035	DOP150S 428-1416					4x0,28x150°	Nozzle
74004	DOP150S 428-4357					4x0,28x150°	Nozzle
740045	DOP160S 430-1436					4x0,30x160°	Nozzle
740048	DOP150S 430-1439					4x0,31x150°	Nozzle
74006	DOP160S 430-4370					4x0,30x160°	Nozzle
740083	DOP140S 435-4369					4x0,35x140°	Nozzle
74010	DOP150S 525-53					5x0,26x150°	Nozzle
74011	DOP150S 525-1402					5x0,25x150°	Nozzle
740115	DOP150S 525-1440					5x0,25x150°	Nozzle
74013	DOP140S 530					5x0,30x140°	Nozzle
740155	DOP150S 535-1417					5x0,36x150°	Nozzle
740163	DOP115S 535-4375					5x0,35x115°	Nozzle
740165	DOP160S 625-1444					6x0,25x160°	Nozzle
74017	DOP160S 625-4343					6x0,25x160°	Nozzle
74045	DOP148P 522-3883						Nozzle
74046	DOP144P 522-3885						Nozzle
74050	DOP152P 522-3898					5x0,20x152°	Nozzle
74055	DOP144P 524-3886						Nozzle
74058	DOP130P 528-3897						Nozzle
74060	DOP122P 533-3827					5x0,34x122°	Nozzle
NMP27350	DO140T735-4501					7x0,35x140°	Nozzle
NMP27828	DO150T828-4533					8x0,28x150°	Nozzle
NMP27839	DO140T840-09					8x0,40x140°	Nozzle
NMP27840	DO150T840-09					8x0,41x150°	Nozzle
NMP27934	DO150T935-4509					9x0,38x150°	Nozzle
NMP27935	DO150T935-4515					9x0,36x150°	Nozzle
NMP30042	DO150U842-4603					8x0,42x150°	Nozzle
NMP30135	DO155U935					9x0,35x155°	Nozzle

## OMAP

79030	OLL160S 3273					4x0,29x160°	Nozzle
79031C	OLL160S 3273-5					4x0,29x160°	Nozzle
79070	OLL150S 8770					5x0,33x150°	Nozzle
79091C	OLL160S 9666/5					4x0,23x160°	Nozzle
79131	OLL160P 9161					4x0,30x160°	Nozzle
79146	OLL155P 9566					4x0,29x155°	Nozzle
79160	OLL150P 9966					4x0,25x150°	Nozzle
79198	OLL150P 10068		CP			4x0,19x150°	Nozzle

## Perkins

76205	2645L605					4x0,31x135°	Nozzle
76206	2645L606					4x0,32x151°	Nozzle
76208	2645L608					4x0,30x146°	Nozzle
76209	2645L609					4x0,30x149°	Nozzle
76211	2645L611					4x0,305x148°	Nozzle
76212	2645L612					4x0,33x140°	Nozzle
76213	2645L613					4x0,30x149°	Nozzle

Our Ref.	Stamping	Part Number	CP	DLC	D/A	Technical Data	Description
----------	----------	-------------	----	-----	-----	----------------	-------------

## Perkins

76215	2645L615					4x0,32x152°	Nozzle
76216	2645L616	21-00106				4x0,30x143°	Nozzle
76217	2645L617					5x0,29x139°	Nozzle

## Ruston

NRS14003	FAPC/B23060A					8x0,36x150°	Nozzle
NRS140031	FAPC/B23060A					8x0,36x150°	Nozzle
NRS14007	FAR-23000					10x0,355x160°	Nozzle
NRS140071	FAR-23000					10x0,355x160°	Nozzle
NRS20100	FVCB/B-23030					8x0,30x140°	Nozzle
NRS20201	FVEB-23030					8x0,41x155°	Nozzle
NRS20212	FVEB/B-23030					8x0,34x140°	Nozzle
NRS20223	FVEBX/B-23030					8x0,43x130°	Nozzle
NRS20244	FVEBX/B-23030A					8x0,405x130°	Nozzle
NRS20265	FVYX					5x0,50x150°	Nozzle
NRS20305	FYH/B-23030					6x0,35x160°	Nozzle
NRS20308	FYHX/B-23030					5x0,43x160°	Nozzle
NRS20327	FYM-23030					5x0,50x150°	Nozzle
NRS20330	FYMC-23030					5x0,55x150°	Nozzle
NRS20345	FYLC					5x0,55x150°	Nozzle
NRS20350	FYLY					5x0,59x150°	Nozzle
NRS30000	F65-00251B					10x0,46x150°	Nozzle
NRS76995	FYC/B 23030					3x0,30x133°	Nozzle
NRS76996	FYW/B 23030					3x0,27x140°	Nozzle

## Seven Diesel

76001	71930	VM				4x0,30x160°	Nozzle
76038	DSL150.A38					4x0,32x150°	Nozzle
76586	1386886	Scania	CP			8x0,23x152°	Nozzle
NBW45278	DL145T 278 IMO1534	MAN 16/24 WGG				8x0,27x145°	Nozzle
NBW45308	DL145T 308	B&W 16/24				8x0,30x145°	Nozzle
NBW50324	5032458R	B&W				10x0,39x148°	Nozzle
NBW69390	2008-1602	IMO1611				13x0,39x164°	Nozzle
NBW69395	2008-1602	IMO1611				13x0,395x164°	Nozzle
NBW69415	2008-1602	IMO1611				13x0,415x164°	Nozzle
NBW69435	2008-1602	IMO1611				13x0,435x164°	Nozzle
NCR10094	CREP 094T	Crepelle				10x0,40x155°	Nozzle
NCR10108	CREP 108T	Crepelle				10x0,37x155°	Nozzle
NMI71080	0.80 - 4N	093 4N 22 10 26 10 7.7R					Nozzle
NMS271	DMS271	Mitsubishi UEC45LA					Nozzle
NMS272	DMS272	Mitsubishi UEC37/88H					Nozzle
NNC15BPG	B28FV1	7x5				10x0,39x148°	Nozzle
NPL17019	BVC352A					8x0,38x110°	Nozzle
NSB61056	NSB61056	Smit&Bolnes				1x4,50	Nozzle
NSB66056	NSB66056	Smit&Bolnes				10x0,55x134°	Nozzle
NSR447	SAURER SPC1085	150-4-47				4x0,47x150°	Nozzle
NVA10004	PO150 8 04	Wartsila				8x0,40x150°	Nozzle
NWK09100	NWK09100	Waukesha				6x0,12x150°	Nozzle
NZS008	CBW-D008	IMO1534				8x0,29x145°	Nozzle
NZS0081	CBW-D008	IMO1534				8x0,29x145°	Nozzle
NZS010	CBW-D010	IMO1702					Nozzle
NZS0205	CMN-D205	IMO1482				9x0,45x148°	Nozzle
NZS0207	CMN-D207	IMO1859				11x0,42x144°	Nozzle
NZS021	CBW-D021	IMO1529-1530				9x0,28x145°	Nozzle

Our Ref.	Stamping	Part Number	CP	DLC	D/A	Technical Data	Description
----------	----------	-------------	----	-----	-----	----------------	-------------

## Seven Diesel

NZS0211	CBW-D0211	IMO1521-1522				8x0,29x145°	Nozzle
NZS028	CBW-D028	IMO1703					Nozzle
NZS1002	CBW-D002	IMO1706				10x0,32x148°	Nozzle
NZS156	ZK156-9335					9x0,335x156°	Nozzle
NZS158	ZK150T832					8x0,32x150°	Nozzle
NZS22164	IMO221646					5x0,26+4x0,24	Nozzle
NZS550	145S 550					5x0,50x145°	Nozzle
NZS560	150S 560					5x0,60x150°	Nozzle
NZS580	150S 580					5x0,80x150°	Nozzle
NZS580-9	150S 590					5x0,90x150°	Nozzle
NZS590	147S 590					5x0,90x147°	Nozzle
NZS67900	9.29.26790.0					1x0,60	Nozzle
NZS750	SLL150S 750	7x0,50x150°				7x0,50x150°	Nozzle
NZS750L	LL150S 750L	7x0,50x150°				7x0,50x150°	Nozzle
NZS760	SLL150S 760	7x0,60x150°				7x0,60x150°	Nozzle
NZS9150	9150	Diesel Zichai				9x0,39x150°	Nozzle
NZS9154	9154	Diesel Zichai				9x0,39x154°	Nozzle
NZS952	26020800009	SXD 9x0,52x148°				9x0,52x148°	Nozzle

## Siemens VDO

76501	M0001P153		CP	DLC		7x0,12x153°	CR Nozzle
76502	M0002P156		CP	DLC		6x0,13x156°	CR Nozzle
76503	M0003P153		CP	DLC		6x0,16x153°	CR Nozzle
765034	M0004P153		CP	DLC		7x0,13x152°	CR Nozzle
765035	M0005P153		CP	DLC		6x0,14x153°	CR Nozzle
76504	M0006P154		CP	DLC		6x0,195x154°	CR Nozzle
765045	M0008P155		CP	DLC		7x0,105x155°	CR Nozzle
76505	M0011P162		CP	DLC		7x0,125x162°	CR Nozzle
765051	M0012P154		CP	DLC		7x0,125x154°	CR Nozzle
765053	M0019P140		CP	DLC		8x0,12x140°	CR Nozzle
765055	M0027P155		CP	DLC		7x0,11x155°	CR Nozzle
765057	M0031P145		CP	DLC		7x0,155x145°	CR Nozzle
7650571	M0032P150		CP	DLC			CR Nozzle
7650575	M0034P150		CP	DLC		8x0,12x150°	CR Nozzle
76506	M0502P147.6		CP	DLC		6x0,125x147°	CR Nozzle
76510	M0604P142		CP	DLC		6x0,15x142°	CR Nozzle
76511	M1001P152		CP	DLC		7x0,13x152°	CR Nozzle
765115	M1002P153		CP	DLC		6x0,15x153°	CR Nozzle
76512	M1003P152		CP	DLC		7x0,11x152°	CR Nozzle
76515	M1600P150		CP	DLC		6x0,19x150°	CR Nozzle
76520	V0600P142		CP	DLC		5x0,165x140°	CR Nozzle
76530	V0605P144		CP	DLC		6x0,12x144°	CR Nozzle
76550	V0802P150	CP0307950949 6L	CP			6x0,27x150°	HEUI Nozzle
765503	V0802P150	CP0425746441 6L	CP			6x0,235x150°	HEUI Nozzle
765506	V0802P150	CP0734984167 6L	CP			6x0,195x150°	HEUI Nozzle
765512	V0803P150		CP			7x0,145x150°	HEUI Nozzle
765513	V0803P150		CP			7x0,165x150°	HEUI Nozzle
76553	V0203P152		CP		D/A	6x0,165x152°	CR Nozzle

## Sigma

75007	IBMDB 1035 C	202 553				2x0,42x10°	Nozzle
-------	--------------	---------	--	--	--	------------	--------

## SKL

NSK10530	TA 535 130 13					5x0,35x130°	Nozzle
----------	---------------	--	--	--	--	-------------	--------

<i>Our Ref.</i>	<i>Stamping</i>	<i>Part Number</i>	<i>CP</i>	<i>DLC</i>	<i>D/A</i>	<i>Technical Data</i>	<i>Description</i>
<b>SKL</b>							
NSK10725	TA 725 155					7x0,25x155°	Nozzle
NSK10830	TA 830 130	651-14016				8x0,30x130°	Nozzle
NSK10835	TA 835 155 35	601-14391				8x0,35x155°	Nozzle
NSK11630	T1A 630-130					6x0,30x130°	Nozzle
NSK11730	T1A 730 130					7x0,30x130°	Nozzle
NSK13490	T2A 940 150	242.018/400-1416				9x0,40x150°	Nozzle
NSK14339	T3A 939 150					9x0,39x150°	Nozzle
NSK25730	TAF 730 130					7x0,30x130°	Nozzle
NSK25831	TAF 830 130	651-14690				8x0,30x130°	Nozzle
NSK25835	TAF 835 155 35	243.014/600-2416				8x0,35x155°	Nozzle
NSK28940	T2AF 940 150 70	243 017/301-3416				9x0,40x150°	Nozzle
NSK28960	T3AF 939 150					9x0,39x150°	Nozzle
NSK30365	U1A 365 140 7	242.001/500-2416				3x0,65x140°	Nozzle
NSK30450	U1A 450 140 6	242.001/400-1416				4x0,50x140°	Nozzle
NSK30505	U1A 5-50 140					5x0,55x140°	Nozzle
NSK30550	U1A 550 140 5	242.001/200-8416				5x0,50x140°	Nozzle
NSK30835	U1A 835 130	242.001/300-0416				8x0,35x130°	Nozzle
NSK35102	U1AF 550 140 52	243.012/900-1416				5x0,50x140°	Nozzle
NSK36205	U1AW 550 140 52	242.002/300 2416				5x0,50x140°	Nozzle
NSK36215	U1AW 575 90 17	242.011/800-0416				5x0,75x90°	Nozzle
NSK36225	U1AW 655 90 17	242.008/100-3416				6x0,55x90°	Nozzle
NSK36240	U1AW 835 130 2	242.003/900-1416				8x0,35x130°	Nozzle

## Stanadyne

59305	20494						Pencil Nozzle
59310	20675						Pencil Nozzle
59312	26632						Pencil Nozzle
59315	26964						Pencil Nozzle
59333	27333						Pencil Nozzle
59336	27336						Pencil Nozzle
59340	28481						Pencil Nozzle
59345	28485						Pencil Nozzle
59350	29279						Pencil Nozzle
59355	32262						Pencil Nozzle
59360	33408						Pencil Nozzle
59365	38416						Pencil Nozzle
77164	ADB152M 164-7	NBM 770052				4x0,27x152°	Nozzle
77165	ADB152M 165-7	NBM 770053				4x0,31x152°	Nozzle
77168	ADB150M 168-7	NBM 770048				4x0,33x150°	Nozzle
77169	ADB155M 169-7	NBM 770000				5x0,32x155°	Nozzle
77175	ADB150M 175-7	NBM 771233				5x0,30x150°	Nozzle
77178	ADB157M 178-7	NBM 771265				8x0,23x157°	Nozzle
77179	ADB157M 179-7	NBM 771266				8x0,26x157°	Nozzle
77184	ADB140M 184-7	NBM 771234				4x0,33x140°	Nozzle
77185	ADB150M 185-7	NBM 771235				5x0,30x150°	Nozzle
77186	ADB140M 186-7	NBM 771236				5x0,30x140°	Nozzle
77200	ADB140M 200-7	NBM 771209				4x0,27x140°	Nozzle
77202	ADB140M 202-7	NBM 771210				4x0,34x140°	Nozzle
77206	ADB152M 206-7	NBM 770054				4x0,29x152°	Nozzle
77208	ADB150M 208-7	NBM 770049				4x0,36x150°	Nozzle
77213	ADB152M 213-7	NBM 770055				4x0,34x152°	Nozzle
77215	ADB160M 215-7	NBM 770047				6x0,30x160°	Nozzle
77217	ADB160M 217-7	NBM 770010				5x0,31x160°	Nozzle
77218	ADB140M 218-7	NBM 771213				5x0,25x140°	Nozzle

Our Ref.	Stamping	Part Number	CP	DLC	D/A	Technical Data	Description
<b>77219</b>	ADB140M 219-7	NBM 771214				5x0,29x140°	Nozzle
<b>77221</b>	ADB140M 221-7	NBM 771225				4x0,38x140°	Nozzle
<b>77222</b>	ADB140M 222-7	NBM 771226				4x0,32x140°	Nozzle
<b>77223</b>	ADB150M 223-7	NBM 771068				4x0,29x150°	Nozzle
<b>77225</b>	ADB160M 225-7	NBM 770022				4x0,35x160°	Nozzle
<b>77226</b>	ADB160M 226-7	NBM 770023				4x0,30x160°	Nozzle
<b>77228</b>	ADB150M 228-7	NBM 770050				4x0,36x150°	Nozzle
<b>77230</b>	ADB150M 230-7	NBM 771070				4x0,28x150°	Nozzle
<b>77231</b>	ADB140M 231-7	NBM 771215				5x0,30x140°	Nozzle
<b>77232</b>	ADB160M 232-7	NBM 770028				4x0,34x160°	Nozzle
<b>77233</b>	ADB140M 233-7	NBM 771227				4x0,34x140°	Nozzle
<b>77607</b>	29608	SDLLA155M 29608				4x0,30x155°	Nozzle
<b>77608</b>	29611	SDLLA155M 29611				4x0,30x154°	Nozzle
<b>776086</b>	29648	SDLLA150M 29648				4x0,30x149°	Nozzle
<b>776087</b>	29649	SDLLA145M 29649				4x0,30x146°	Nozzle
<b>77610</b>	29943	SDLLA142M 991				4x0,31x142°	Nozzle
<b>776104</b>	30064	SDLLA150M 30064				4x0,30x149°	Nozzle
<b>776106</b>	30146	SDLL160S 30146				4x0,275x160°	Nozzle
<b>77611</b>	30525	SDLLA143M 30525				5x0,25x180°	Nozzle
<b>776111</b>	30526	SDLLA143M 30526				5x0,24x144°	Nozzle
<b>776113</b>	30528	SDLLA143M 30528				5x0,26x141°	Nozzle
<b>776114</b>	30754	SDLLA160M 30754				4x0,21x160°	Nozzle
<b>7761142</b>	31057	SDLLA150M 31057				4x0,305x148°	Nozzle
<b>7761143</b>	31058	SDLLA150M 31058				4x0,32x152°	Nozzle
<b>776115</b>	31542	SDLLA150M 31542				4x0,21x145°	Nozzle
<b>776118</b>	32078	SDLLA160P 32078				4x0,24x156°	Nozzle
<b>77612</b>	33426	SDLLA152M 33426				5x0,25x145°	Nozzle
<b>776125</b>	33877	SDLLA152M 33877				5x0,30x149°	Nozzle
<b>776126</b>	34359	SDLLA152M 34359				5x0,24x152°	Nozzle
<b>7761267</b>	34447	SDLLA145M 34447				5x0,22x145°	Nozzle
<b>77612672</b>	34858	SDLLA134M 34858				5x0,30x134°	Nozzle
<b>7761268</b>	34861	SDLLA134M 34861				5x0,275x134°	Nozzle
<b>7761269</b>	34862	SDSLA140M 34862				5x0,29x140°	Nozzle
<b>776127</b>	35235	SDLLA145M 35235				5x0,30x141°	Nozzle
<b>776128</b>	35304	SDLLA145M 35304				5x0,26x142°	Nozzle
<b>7761283</b>	35583	SDLLA142M 35583				5x0,32x139°	Nozzle
<b>7761285</b>	35622	SDLLA145M 35622				5x0,34x145°	Nozzle
<b>776129</b>	35926	SDLLA152M 35926				5x0,25x152°	Nozzle
<b>7761292</b>	36896						Nozzle
<b>7761293</b>	37068	SDLLA142P 37068				5x0,28x139°	Nozzle
<b>7761293</b>	37068	SDLLA142P 37068				5x0,28x139°	Nozzle
<b>7761295</b>	37981	SDLLA145P 37981				6x0,27x140°	Nozzle
<b>7761295</b>	37981	SDLLA145P 37981				6x0,27x140°	Nozzle
<b>77612953</b>	37985						Nozzle
<b>7761296</b>	39019	SDSLA143M 39019				5x0,27x143°	Nozzle
<b>7761297</b>	39472	SDSLA143M 39472				5x0,25x143°	Nozzle
<b>77612975</b>	42308	SDSLA140P 42308				5x0,27x140°	Nozzle
<b>7761298</b>	42321	SDLLA150P 42321				5x0,27x150°	Nozzle
<b>77613</b>	770049	NBM 770049				4x0,35x150°	Nozzle
<b>776132</b>	770051	NBM 770051				4x0,34x140°	Nozzle
<b>77614</b>	770069	NBM 770069				4x0,36x144°	Nozzle
<b>77615</b>	770086	NBM 770086				6x0,29x161°	Nozzle
<b>77623</b>	770173	NBM 770173				4x0,29x155°	Nozzle
<b>77676</b>	770316	NBM 770316				6x0,24x160°	Nozzle

Our Ref.	Stamping	Part Number	CP	DLC	D/A	Technical Data	Description
<b>Stanadyne</b>							
77705	770405	NBM 770405				6x0,26x154°	Nozzle
77710	770763	NBM 770763				5x0,31x141°	Nozzle
77729	770829	NBM 770829				4x0,34x140°	Nozzle
77739	770939	NBM 770939				5x0,27x143°	Nozzle
77744	770967	NBM 770967				5x0,31x141°	Nozzle
77751	770991	NBM 770991				4x0,30x142°	Nozzle
77773	771573	NBM 771573				6x0,27x150°	Nozzle
77790	771890	NBM 771890				5x0,25x144°	Nozzle
77951	775234	DLL150P 451W				4x0,235x150°	Nozzle
77952	775702	DLL150P 452W				4x0,26x145°	Nozzle

## Steyr

NST519	519/0 YD	STEYR MARINE				5x0,23x145°	Nozzle
NST569	569/1 RR	STEYR MARINE				6x0,17x151°	Nozzle

## Sulzer

NSU22000	3107 092 376 200	6307/08 (BH22)				6x0,275x130°	Nozzle
NSU22001	3107 092 376 201	6307/08 (BH22)				6x0,30x160°	Nozzle
NSU22002	3107 092 376 202	6307/08 (BH22)				6x0,325x130°	Nozzle
NSU22003	3107 092 376 203	6307/08 (BH22)				6x0,375x130°	Nozzle
NSU36000	2107 102 522 200	H27240 (20/24)				7x0,28x159°	Nozzle
NSU36001	2107 102 522 201	H27240 (20/24)				7x0,26x159°	Nozzle
NSU36002	2107 102 522 202	H27240 (20/24)				8x0,22x160°	Nozzle
NSU36003	2107 102 522 203	H27240 (20/24)				8x0,26x160°	Nozzle
NSU36004	2107 102 522 204	H27240 (20/24)				9x0,23x159°	Nozzle
NSU36005	2107 102 522 205	H27240 (20/24)				9x0,25x159°	Nozzle
NSU37200	2107 232 732 200	A20/24H 400 bar				8x0,22x160°	Nozzle
NSU37201	2107 232 732 201	A20/24H 400 bar				8x0,26x160°	Nozzle
NSU37301	3107 032 144 201	H27240 (A20/24H)				7x0,32x159°	Nozzle
NSU37371	3107 070 418 201	(BH29)				8x0,275x135°	Nozzle
NSU37372	3107 070 418 202	(BH29)				7x0,275x135°	Nozzle
NSU37373	3107 070 418 203	(BH29)				8x0,35x135°	Nozzle
NSU37374	3107 070 418 204	(BH29)				8x0,40x135°	Nozzle
NSU37390	2107 232 733 200	(20/24) 400 bar				7x0,28x159°	Nozzle
NSU37391	2107 232 733 201	(20/24) 400 bar				7x0,26x159°	Nozzle
NSU37394	2107 232 733 204	(20/24) 400 bar				9x0,23x159°	Nozzle
NSU37395	2107 232 733 205	(20/24) 400 bar				9x0,25x159°	Nozzle
NSU37400	3107 104 691 200	H27240 (A20/24H)				8x0,22x160°	Nozzle
NSU37401	3107 104 691 201	H27240 (A20/24H)				8x0,26x160°	Nozzle
NSU63000	2107 034 537 200	H27240 (25/30)				9x0,325x150°	Nozzle
NSU630013	H27240	(25/30)				9x0,325x155°	Nozzle
NSU630015	H27240	(25/30)				9x0,35x155°	Nozzle
NSU63003	2107 104 541 200	H27240 (25/30)				10x0,33x158°	Nozzle
NSU63004	2107 104 541 200	H27240 (25/30)				10x0,350x158°	Nozzle
NSU63005	2107 104 541 201	H27240 (25/30)				10x0,30x158°	Nozzle
NSU63010	2107 104 696 200	H27240 (25/30)				8x0,375x158°	Nozzle
NSU630102	H27240	(25/30)				8x0,40x158°	Nozzle
NSU63011	2107 104 696 201	H27240 (25/30)				9x0,32x158°	Nozzle
NSU630114	2107 104 696 201	H27240 (25/30)				9x0,325x158°	Nozzle
NSU63012	2107 104 696 202	H27240 (25/30)				9x0,285x150°	Nozzle
NSU63013	H27240	(25/30)				9x0,30x150°	Nozzle
NSU65240	S20					12x0,24x160°	Nozzle
NSU65255	S20					12x0,255x160°	Nozzle
NSU65275	S20					12x0,275x160°	Nozzle

Our Ref.	Stamping	Part Number	CP	DLC	D/A	Technical Data	Description
----------	----------	-------------	----	-----	-----	----------------	-------------

## Sulzer

NSU65285	S20					12x0,285x160°	Nozzle
NSU66239	40S					10x0,65x144°	Nozzle
NSU66240	40S	KS27240 (ZA40S)				10x0,65x144°	Nozzle
NSU66241	40S	KS27240 (ZA40S)				12x0,65x160°	Nozzle
NSU662419	40S					13x0,60x160°	Nozzle
NSU66242	40S	KS27240 (ZA40S)				13x0,60x160°	Nozzle
NSU68000	2107 110 718 200	K27240 (40/48)				8x0,525x160°	Nozzle
NSU68001	2107 110 718 201	K27240 (40/48)				9x0,525x160°	Nozzle
NSU68002	2107 110 718 202	K27240 (40/48)				12x0,475x160°	Nozzle
NSU68003	2107 110 718 203	K27240 (40/48)				12x0,50x160°	Nozzle
NSU68004	2107 110 718 204	K27240 (40/48)				12x0,525x160°	Nozzle
NSU68005	2107 110 718 205	K27240 (40/48)				12x0,550x160°	Nozzle
NSU68017	SU8778 1 201	K27240 (40/48)				8x0,550x160°	Nozzle
NSU69072	194.894 - 1.2	2107 194 894 (RT)				1x4	Nozzle
NSU69074	225.172 - 0,9	2107 225 172 (RT)				1x4	Nozzle
NSU69076	252.402 - 1,6	2107 252 402 (RT)				1x4	Nozzle

## Wartsila

NWA080M	CWA-D080M						Nozzle
NWA084	CWA-D084						Nozzle

## Woodward-L'Orange

NBW6910A	VUM-U910A/E	IMO1235				13x0,43x82°	Nozzle
NBW6910B	VUM-U910B/E	IMO1611				13x0,39x82°	Nozzle
NBW6910C	VUM-U910C/E	IMO1758				13x0,41x82°	Nozzle
NLG10ACA	LT-ACA					8x0,34x145°	Nozzle
NLG10ACC	LT-ACC					9x0,35x145°	Nozzle
NLG10ACF	LT-ACF					8x0,35x150°	Nozzle
NLG10ADA	LT-ADA					10x0,33x150°	Nozzle
NLG10LBD	LT-LBD					8x0,20x150°	Nozzle
NLG10LGQ	LT-LGQ					8x0,35x140°	Nozzle
NLG10LJG	LT-LJG					8x0,25x150°	Nozzle
NLG10LUG	LT-LUG/E					6x0,39x155°	Nozzle
NLG10LXA	LT-LXA					9x0,35+1x0,20	Nozzle
NLG10LXAA	LT-LXA	9 HOLES				9x0,35x140°	Nozzle
NLG10LXW	LT-LXW					8x0,31x150°	Nozzle
NLG10LYB	LT-LYB					7x0,36x140°	Nozzle
NLG10LZQ	LT-LZQ					8x0,36x140°	Nozzle
NLG10LZR	LT-LZR					8x0,36x150°	Nozzle
NLG12AAH	LLT-AAH					6x0,51x150°	Nozzle
NLG1490A	LTB-U900A						Nozzle
NLG15BBE	LTO-BBE <sub>m</sub>					5x0,45x155°	Nozzle
NLG15BBG	LTO-BBG					8x0,37x132°	Nozzle
NLG15BEV	LTO-BEV					6x0,40x130°	Nozzle
NLG15BFH	LTO-BFH					5x0,38x110°	Nozzle
NLG15BFW	LTO-BFW					4x0,50x110°	Nozzle
NLG15BGR	LTO-BGR					4x0,55x110°	Nozzle
NLG15BGZ	LTO-BGZ					8x0,36x150°	Nozzle
NLG15BHE	LTO-BHE					8x0,32x145°	Nozzle
NLG15BJH	LTO-BJH					8x0,36x150°	Nozzle
NLG15BKV	LTO-BKV					10x0,39x148°	Nozzle
NLG15BKZ	LTO-BKZ					9x0,41x156°	Nozzle
NLG15BLJ	LTO-BLJ					10x0,33x150°	Nozzle
NLG15BLQ	LTO-BLQ					8x0,33x148°	Nozzle

Our Ref.	Stamping	Part Number	CP	DLC	D/A	Technical Data	Description
<b>NLG15BME</b>	LTO-BME/E	04079765				7x0,43x145°	Nozzle
<b>NLG15BMQ</b>	LTO-BMQ					7x0,41x140°	Nozzle
<b>NLG15BMW</b>	LTO-BMW					8x0,33x148°	Nozzle
<b>NLG15BNE</b>	LTO-BNE					10x0,39x148°	Nozzle
<b>NLG15BNG</b>	LTO-BNG	4091878				7x0,41x145°	Nozzle
<b>NLG15BNZ</b>	LTO-BNZ	old version				10x0,36x130°	Nozzle
<b>NLG15BNZ1</b>	LTO-BNZ	new version				10x0,36x130°	Nozzle
<b>NLG15BPF</b>	LTO-BPF/E					8x0,325x145°	Nozzle
<b>NLG15BPG/EV</b>	LTO-BPG					10x0,39x148°	Nozzle
<b>NLG15BPJ</b>	LTO-BPJ	IMO-17.06				10x0,32x148°	Nozzle
<b>NLG16089</b>	LTO-U9089a/E					8x0,29x145°	Nozzle
<b>NLG16090</b>	LTO-U9089b/E					9x0,28x145°	Nozzle
<b>NLG16108</b>	LTO-U9108a					8x0,34x159°	Nozzle
<b>NLG16171</b>	LTO-U9171W/EV1						Nozzle
<b>NLG30UBQ</b>	LU-UBQ					8x0,45x130°	Nozzle
<b>NLG30UDR</b>	LU-UDR					8x0,40x130°	Nozzle
<b>NLG30UFP</b>	LU-UFP					6x0,45x115°	Nozzle
<b>NLG411G</b>	LUO-U911G						Nozzle
<b>NLG60012</b>	VUM-T629Y					9x0,28x66°	Nozzle
<b>NLG60033</b>	VUM-U933					1x3,0	Nozzle
<b>NLG60034</b>	VUM-U934a/E					9x0,45x148°	Nozzle
<b>NLG60036</b>	VUM-U936a/E						Nozzle
<b>NLG600361</b>	VUM-U936b/E						Nozzle
<b>NLG60Y33</b>	VUM-U933y					1x3,0	Nozzle
<b>NLG62BAA</b>	VUO-BAA					6x0,55x130°	Nozzle
<b>NLG62BAC</b>	VUO-BAC					6x0,45x130°	Nozzle
<b>NLG62BAD</b>	VUO-BAD					6x0,52x110°	Nozzle
<b>NLG62BAE</b>	VUO-BAE					6x0,40x110°	Nozzle
<b>NLG62BAF</b>	VUO-BAF					6x0,45x110°	Nozzle
<b>NLG62BAG</b>	VUO-BAG					6x0,40x130°	Nozzle
<b>NLG62BAK</b>	VUO-BAK					6x0,35x130°	Nozzle
<b>NLG62BAL</b>	VUO-BAL					6x0,30x130°	Nozzle
<b>NLG62BAM</b>	VUO-BAM					6x0,45x120°	Nozzle
<b>NLG62BAN</b>	VUO-BAN					6x0,40x120°	Nozzle
<b>NLG62CAA</b>	VUO-CAA					6x0,55x110°	Nozzle
<b>NLG62CAB</b>	VUO-CAB					6x0,55x120°	Nozzle
<b>NLG62CAC</b>	VUO-CAC					6x0,50x110°	Nozzle
<b>NLG62CAD</b>	VUO-CAD					6x0,50x120°	Nozzle
<b>NLG62CAE</b>	VUO-CAE					6x0,60x120°	Nozzle
<b>NLG64136</b>	VUO-T136g					6x0,74x110°	Nozzle
<b>NLG64139</b>	VUO-T136r					8x0,60x120°	Nozzle
<b>NLG64145</b>	VUO-T136fb					6x0,85x110°	Nozzle
<b>NLG64150</b>	VUO-T136ib	233 222 011				6x0,78x110°	Nozzle
<b>NLG64268</b>	VUO-T168b	Ex VUO-U051b				10x0,57x150°	Nozzle
<b>NLG64270</b>	VUO-T168c/E	Ex VUO-U051c/E				10x0,60x150°	Nozzle
<b>NLG65906</b>	VUO-U906					1x2.5	Nozzle
<b>NLG65909</b>	VUO-U909ay/E					8x0,52x130°	Nozzle
<b>NLG65910</b>	VUO-U910a					8x0,52x130°	Nozzle
<b>NLG65934</b>	VUO-U932c					1x4.0	Nozzle
<b>NLG65935</b>	VUO-U932d					1x4.0	Nozzle
<b>NLG65944</b>	VUO-U944a					6x0,60x110°	Nozzle
<b>NLG65945</b>	VUO-U944b					6x0,60x135°	Nozzle
<b>NLG65946</b>	VUO-U944c					6x0,65x110°	Nozzle
<b>NLG66744</b>	VUO-U954acy/E					8x0,60x140°	Nozzle

Our Ref.	Stamping	Part Number	CP	DLC	D/A	Technical Data	Description
<b>NLG66746</b>	VUO-U954aey/E					6x0,55x130°	Nozzle
<b>NLG66748</b>	VUO-U954afy/E					8x0,53x140°	Nozzle
<b>NLG66750</b>	VUO-U954by/E					9x0,42x130°	Nozzle
<b>NLG66752</b>	VUO-U954fy/E					6x0,50x110°	Nozzle
<b>NLG66754</b>	VUO-U954gy/E					6x0,55x110°	Nozzle
<b>NLG66954</b>	VUO-U955a/E					5x0,55x120°	Nozzle
<b>NLG66956</b>	VUO-U955b/E					9x0,42x130°	Nozzle
<b>NLG66957</b>	VUO-U955c/E					9x0,40x130°	Nozzle
<b>NLG66958</b>	VUO-U955d/E					9x0,45x130°	Nozzle
<b>NLG66959</b>	VUO-U955e/E					5x0,60x110°	Nozzle
<b>NLG66960</b>	VUO-U955f/E					6x0,55x110°	Nozzle
<b>NLG66961</b>	VUO-U955g/E					6x0,60x110°	Nozzle
<b>NLG66962</b>	VUO-U955h/E					6x0,50x110°	Nozzle
<b>NLG66963</b>	VUO-U955k/E					8x0,60x140°	Nozzle
<b>NLG66964</b>	VUO-U955i/E					6x0,45x110°	Nozzle
<b>NLG66965</b>	VUO-U955l/E					8x0,47x140°	Nozzle
<b>NLG66966</b>	VUO-U955m/E					8x0,53x140°	Nozzle
<b>NLG67050</b>	VUO-U967l					9x0,50x140°	Nozzle
<b>NLG67052</b>	VUO-U967ly	Heavy Oil				9x0,50x140°	Nozzle
<b>NLG67169</b>	VUO-U969a					1x4.0	Nozzle
<b>NLG67376</b>	VUO-U976a/E					9x0,48x155°	Nozzle
<b>NLG67383</b>	VUO-U976l/E					10x0,48x160°	Nozzle
<b>NLG67388</b>	VUO-U976p/E					10x0,48x150°	Nozzle
<b>NLG67389</b>	VUO-U976q/E					10x0,50x150°	Nozzle
<b>NLG67808</b>	VUO-U988a/E	01267 9421341				9x0,48x155°	Nozzle
<b>NLG68C99</b>	VUO-U999c/E					9x0,51x130°	Nozzle
<b>NLG69013</b>	VUO-U9013by/E					8x0,47x130°	Nozzle
<b>NLG69A14</b>	VUO-U9014a/E					8x0,54x140°	Nozzle
<b>NLG70034</b>	VUO-U9034b/E					10x0,53x150°	Nozzle
<b>NLG70137</b>	VUO-U9037c/E					12x0,50x150°	Nozzle
<b>NLG70196</b>	VUO-U9096C/E					9x0,48x155°	Nozzle
<b>NLG70215</b>	VUO-U9115p/E					10x0,54x158°	Nozzle
<b>NLG70241</b>	VUO-U9141d/EV					9x0,34x154°	Nozzle
<b>NLG70279</b>	VUO-U9179c/EE					12x0,51x150°	Nozzle
<b>NLG70281</b>	VUO-U9181a						Nozzle
<b>NLG72104</b>	VUY-U904a					5x0,55x140°	Nozzle
<b>NLG72106</b>	VUY-U904c					5x0,50x140°	Nozzle
<b>NLG72107</b>	VUY-U904d					8x0,35x130°	Nozzle
<b>NLG72115</b>	VUY-U905a					10x0,46x130°	Nozzle
<b>NLG72116</b>	VUY-U905b					10x0,60x140°	Nozzle
<b>NLG72117</b>	VUY-U905c					10x0,55x140°	Nozzle
<b>NLG72129</b>	VUY-U909					5x0,50x140°	Nozzle
<b>NLG72512</b>	VUY-U912					5x0,50x140°	Nozzle
<b>NLG74213</b>	VVM-T213a					10x0,48x70°	Nozzle
<b>NLG74214</b>	VVM-T213b					10x0,43x70°	Nozzle
<b>NLG74215</b>	VVM-T213c					10x0,62x72°	Nozzle
<b>NLG74216</b>	VVM-T213d					8x0,30x67°	Nozzle
<b>NLG74217</b>	VVM-T213e					8x0,35x67°	Nozzle
<b>NLG74218</b>	VVM-T213f					10x0,38x70°	Nozzle
<b>NLG74219</b>	VVM-T213g					10x0,60x72°	Nozzle
<b>NLG74220</b>	VVM-T213h					10x0,40x70°	Nozzle
<b>NLG74221</b>	VVM-T213i					10x0,58x70°	Nozzle
<b>NLG74222</b>	VVM-T213k					10x0,60x70°	Nozzle
<b>NLG74223</b>	VVM-T213l					10x0,45x70°	Nozzle

Our Ref.	Stamping	Part Number	CP	DLC	D/A	Technical Data	Description
<b>NLG75V01</b>	VVM-U901					1x4.50	Nozzle
<b>NLG76135</b>	VVO-U935K					10x0,71x150°	Nozzle
<b>NLG76143</b>	VVO-U943g/E					11x0,59x154°	Nozzle
<b>NLG76153</b>	VVO-U953g/E					11x0,59x155°	Nozzle
<b>NLG76176</b>	VVO-U976L/E					12x0,57x155°	Nozzle
<b>NLG77A00</b>	VVP-U900a	4 holes				10x0,60x140°	Nozzle
<b>NLG77A01</b>	VVP-U900a	6 holes				10x0,60x140°	Nozzle
<b>NLG77B00</b>	VVP-U900b	4 holes				10x0,55x140°	Nozzle
<b>NLG77B01</b>	VVP-U900b	6 holes				10x0,55x140°	Nozzle
<b>NLG77C00</b>	VVP-U900c	4 holes				10x0,65x140°	Nozzle
<b>NLG77C01</b>	VVP-U900c	6 holes				10x0,65x140°	Nozzle
<b>NLG77D00</b>	VVP-U900d					10x0,50x140°	Nozzle
<b>NLG77E00</b>	VVP-U900e					10x0,52x140°	Nozzle
<b>NLG77F00</b>	VVP-U900f					9x0,68x140°	Nozzle
<b>NLG77I00</b>	VVP-U900i					10x0,48x140°	Nozzle
<b>NLG77L00</b>	VVP-U900l					10x0,625x140°	Nozzle
<b>NLG77M00</b>	VVP-U900m					10x0,725x140°	Nozzle
<b>NLG78101</b>	VXP-U901a					10x1,00x140°	Nozzle
<b>NLG79105</b>	VXW-U905					1x3.0	Nozzle
<b>NLG79200</b>	VWK-U900A/E					11x0,72x150°	Nozzle
<b>NLG79201</b>	VWK-U901A/E					11x0,71x150°	Nozzle
<b>NLG79301</b>	VWM-U901	4D14552 & 4D14557				1x4,5	Nozzle
<b>NLG79350</b>	VWM-T950S	D140214				10x0,60x144°	Nozzle
<b>NLG79502</b>	VWW-U902a					1x2.0	Nozzle
<b>NZS1065</b>	WAF 1065-140-45	G203011200				10x0,65	Nozzle
<b>NZS1070</b>	WAF 1070-140-45	G203017000				10x0,70	Nozzle

## Yanmar

<b>400011</b>	DN4SK 1						Pintle Nozzle
<b>43563</b>	Y-DN0PD2						Pintle Nozzle
<b>45204</b>	Y150P204 BO						Nozzle
<b>45244</b>	Y150P244					4x0,24x150°	Nozzle
<b>45265</b>	Y159P165					5x0,16x159°	Nozzle
<b>76316</b>	N16-5C					4x0,30x100°	Nozzle
<b>76317</b>	N16-5F	103200-53000				4x0,30x100°	Nozzle
<b>76320</b>	NP 35					5x0,31x148°	Nozzle
<b>763205</b>	Y-DLLA140S324 B4	127610-53004					Nozzle
<b>76321</b>	Y-DLLA140S344 B2					4x0,34x139°	Nozzle
<b>76323</b>	Y-DLLA150S294 N0	105700-53000				4x0,29x150°	Nozzle
<b>76324</b>	Y-DLLA150S325 A2					5x0,31x143°	Nozzle
<b>76325</b>	Y-DLLA150S334 S0					4x0,33x150°	Nozzle
<b>76326</b>	Y-DLLA150S364 A1					4x0,36x150°	Nozzle
<b>76327</b>	Y-DLLA150S384 A1					4x0,34x139°	Nozzle
<b>76329</b>	Y-DLLA155S355 A20					5x0,35x155°	Nozzle
<b>763291</b>	Y-DLL145S 336 G1					6x0,31x143°	Nozzle
<b>763292</b>	Y-DLL150S 287 GZA					7x0,27x151°	Nozzle
<b>763293</b>	Y-DLL150S 307 HZ					7x0,29x151°	Nozzle
<b>763294</b>	Y-DLL150S 317 GD1					7x0,28x149°	Nozzle
<b>763296</b>	Y-DLL150S 326 AT					6x0,31x152°	Nozzle
<b>763297</b>	Y-DLL150S 345 B0					5x0,33x149°	Nozzle
<b>763298</b>	Y-DLL150S 355 A0					5x0,34x151°	Nozzle
<b>76330</b>	Y-DLL150S 366H					6x0,36x150°	Nozzle
<b>763301</b>	Y-DLL150S 366 K0					6x0,36x149°	Nozzle
<b>76333</b>	Y-DLL155S 297 KZ					7x0,28x153°	Nozzle

Our Ref.	Stamping	Part Number	CP	DLC	D/A	Technical Data	Description
<b>Yanmar</b>							
76335	Y-DLL155S 298EZ0					8x0,28x155°	Nozzle
76345	Y-DLL160278S90224FA					8x0,29+4x0,22x160°	Nozzle
76348	Y-DLL160308S90224FA2					8x0,27+4x0,22x160°	Nozzle
NYM10505	YDL150T258D	137600-53000				8x0,25x150°	Nozzle
NYM10510	YDL150T308S					8x0,30x150°	Nozzle
NYM10511	YDL160T308					8x0,30x160°	Nozzle
NYM10513	YDL160T318					8x0,31x160°	Nozzle
NYM10515	YDL150T328S					8x0,32x150°	Nozzle
NYM10526	YDL150T366D1	140677-53001				6x0,36x150°	Nozzle
NYM10540	YDL150T408S					8x0,40x150°	Nozzle
NYM15318	YDLL-140T388B					8x0,38x140°	Nozzle
NYM15343	YDLL-1532910T90205U						Nozzle
NYM15353	YDLL-153288T90224C					8x0,28+4x0,22	Nozzle
NYM153531	YDLL-153288T90224C					8x0,28+4x0,22	Nozzle
NYM15363	YDLL-153348T90284C					8x0,34+4x0,28	Nozzle
NYM153631	YDLL-153348T90284C					8x0,34+4x0,28	Nozzle
NYM20288	YDLF150T288 DVH					8x0,28x150°	Nozzle
NYM20298	YDLF150T358 DV	141616-53110				8x0,35x150°	Nozzle
NYM30409	YDL135U409	159626-53011				9x0,40x135°	Nozzle
NYM30429	YDL135U459K					9x0,45x135°	Nozzle
NYM30458	YDLF150U408	Yanmar 208				8x0,40x150°	Nozzle
NYM30569	YDLF-135V569B					9x0,56x135°	Nozzle
NYM305691	YDLF-135V569B					9x0,56x135°	Nozzle
NYM30570	YDLF140V5312					12x0,53x140°	Nozzle
NYM30571	YDLF150V5312					12x0,53x150°	Nozzle
NYM305711	YDLF154V5312					12x0,53x154°	Nozzle
NYM30572	YDLF155V5312					12x0,53x155°	Nozzle

## Zexel

43500	DN15PDN 100	105007-1000					Pintle Nozzle
43502	DN0PDN 102	105007-1020					Pintle Nozzle
43508	DN0PDN 108	105007-1080					Pintle Nozzle
43512	DN0PDN 112	105007-1120					Pintle Nozzle
43513	DN0PDN 113	105007-1130					Pintle Nozzle
43517	DN4PDN 117	105007-1170					Pintle Nozzle
43521	DN0PDN 121	105007-1210					Pintle Nozzle
43522	DN0PDN 122	105007-1222					Pintle Nozzle
43524	DN0PDN 124	105007-1240					Pintle Nozzle
43529	DN10PDN 129	105007-1290					Pintle Nozzle
43530	DN10PDN 130	105007-1300					Pintle Nozzle
43535	DN10PDN 135	105007-1350					Pintle Nozzle
43554	DN4PDN 154	105007-1540					Pintle Nozzle
43558	DN0PDN 158	105007-1580					Pintle Nozzle
43561	DN4PD 1	105007-1180					Pintle Nozzle
43562	DN0PD 2	105007-1390					Pintle Nozzle
43567	DN4PD 57	105007-1260					Pintle Nozzle
73001	NP-DLL140S256NP 1	105015-0550				6x0,25x140°	Nozzle
73002	NP-DLL150S328NP 33	105015-2570				8x0,32x150°	Nozzle
73003	NP-DLL140S256NP 38	105015-2790				6x0,25x140°	Nozzle
73004	NP-DLL150S328NP 52	105015-3280				8x0,32x150°	Nozzle
73005	NP-DLL35S671NP 92	105015-3720				1x0,67x35°	Nozzle
73006	NP-DLL16S561N 389	105015-3890				1x0,56x16°	Nozzle
73008	NP-DLL155S288N 431	105015-4310				8x0,28x155°	Nozzle
73009	NP-DLL160S307N 435	105015-4350				7x0,30x160°	Nozzle

<i>Our Ref.</i>	<i>Stamping</i>	<i>Part Number</i>	<i>CP</i>	<i>DLC</i>	<i>D/A</i>	<i>Technical Data</i>	<i>Description</i>
<b>Zexel</b>							
730095	NP-DLL155SN 521	105015-5210				8x0,36x155°	Nozzle
730096	NP-DLL155SN 595	105015-5950				5x0,38x155°	Nozzle
730097	NP-DLL160SN 683	105015-6830					Nozzle
730098	NP-DLL160SN 716	105015-7160				8x0,27x160°	Nozzle
730099	NP-DLL157SN 829	105015-8290				8x0,28x157°	Nozzle
73011	NP-DLLA150S334NP 3	105015-2670				4x0,33x150°	Nozzle
73012	NP-DLLA169S304NP 5	105015-2770				4x0,30x169°	Nozzle
73013	NP-DLLA166S374NP 6	105015-2780				4x0,37x166°	Nozzle
73014	NP-DLLA150S384NP 13	105015-3090				4x0,38x150°	Nozzle
73015	NP-DLLA150S404NP 13	105015-3210				4x0,40x150°	Nozzle
73016	NP-DLLA14.5S701NP 15	105015-3150				1x0,70x14,5°	Nozzle
73017	NP-DLLA150S3840NP 16	105015-3160				2x0,38+2x0,40	Nozzle
73018	NP-DLLA166S414NP 46	105015-3100				2x0,37+2x0,40	Nozzle
73019	NP-DLLA152S324NP 48	105015-3240				4x0,32x152°	Nozzle
730191	NP-DLLA152S344NP 48	105015-3220				4x0,34x152°	Nozzle
73020	NP-DLLA160S354NP 49	105015-3690				4x0,35x160°	Nozzle
73021	NP-DLLA154S344NP 54	105015-3310				4x0,34x154°	Nozzle
73022	NP-DLLA156S344NP 55	105015-3330				4x0,34x156°	Nozzle
73023	NP-DLLA171S374NP 58	105015-3360				2x0,33+2x0,36	Nozzle
73024	NP-DLLA168S304NP 59	105015-3370				4x0,30x168°	Nozzle
730249	NP-DLLA166S384NP 72	105015-3510				2x0,35+2x0,37	Nozzle
73025	NP-DLLA150S384NP 73	105015-3520				4x0,38x150°	Nozzle
73026	NP-DLLA150S394NP 76	105015-3550				2x0,35+2x0,38	Nozzle
730269	NP-DLLA176S324NP 80	105015-3590				4x0,33x176°	Nozzle
73027	NP-DLLA154S324NP 81	105015-3600				4x0,32x154°	Nozzle
73028	NP-DLLA150S344NP 82	105015-3610				4x0,34x150°	Nozzle
73029	NP-DLLA150S414NP 83	105015-3620				4x0,41x150°	Nozzle
73030	NP-DLLA151S354NP 86	105015-3650				4x0,35x151°	Nozzle
73031	NP-DLLA160S354NP 88	105015-3670				4x0,35x160°	Nozzle
73032	NP-DLLA150S334NP 89	105015-3680				4x0,33x150°	Nozzle
73033	NP-DLLA155S334NP 96	105015-3760				2x0,31+2x0,33	Nozzle
73034	NP-DLLA166S384NP 97	105015-3770				4x0,38x166°	Nozzle
73035	NP-DLLA150S334N 385	105015-3850				4x0,33x150°	Nozzle
73036	NP-DLLA154S284N 393	105015-3930				4x0,28x154°	Nozzle
730361	NP-DLLA144S354N 403	105015-4030				4x0,35x144°	Nozzle
7303611	NP-DLLA160S354N 405	105015-4050				4x0,35x160°	Nozzle
730362	NP-DLLA152S354N 406	105015-4060				4x0,35x152°	Nozzle
730363	NP-DLLA138S364N 409	105015-4090				4x0,36x138°	Nozzle
730364	NP-DLLA150S394N 411	105015-4110				2x0,36+2x0,39	Nozzle
73037	NP-DLLA154S324N 413	105015-4130				4x0,32x154°	Nozzle
730371	NP-DLLA150S374N 414	105015-4140				2x0,34+2x0,37	Nozzle
73038	NP-DLLA137S374N 417	105015-4170				4x0,37x137°	Nozzle
730381	NP-DLLA154S334N 419	105015-4190				4x0,33x154°	Nozzle
73039	NP-DLLA160S295N 422	105015-4220				5x0,29x160°	Nozzle
73040	NP-DLLA154S344N 424	105015-4240				4x0,34x154°	Nozzle
73041	NP-DLLA160S385N 426	105015-4260				5x0,38x160°	Nozzle
730412	NP-DLLA160S424N 427	105015-4270				4x0,42x160°	Nozzle
73042	NP-DLLA146S394N 430	105015-4300				2x0,37+2x0,39	Nozzle
730425	NP-DLLA105S304N 433	105015-4330				4x0,30x105°	Nozzle
73044	NP-DLLA158S325N 437	105015-4370				5x0,32x158°	Nozzle
73045	NP-DLLA154S374N 438	105015-4380				4x0,37x154°	Nozzle
73046	NP-DLLA146S344N 439	105015-4390				4x0,34x146°	Nozzle
730460	NP-DLLA154S324N 451	105015-4510				4x0,32x154°	Nozzle
7304602	NP-DLLA150S394N 452	105015-4520				2x0,36+2x0,38	2 Springs Nozzle

<i>Our Ref.</i>	<i>Stamping</i>	<i>Part Number</i>	<i>CP</i>	<i>DLC</i>	<i>D/A</i>	<i>Technical Data</i>	<i>Description</i>
<b>Zexel</b>							
730461	NP-DLLA145S344N 453	105015-4530				4x0,34x145°	Nozzle
730462	NP-DLLA146S394N 455	105015-4550				4x0,39x146°	Nozzle
730463	NP-DLLA155S324N 456	105015-4560				2x0,29+2x0,31	Nozzle
730464	NP-DLLA162S384N 457	105015-4570				2x0,34+2x0,38	Nozzle
730467	NP-DLLA155S365N 458	105015-4580				5x0,36x155°	Nozzle
73047	NP-DLLA154S424N 459	105015-4590				4x0,42x154°	Nozzle
730478	NP-DLLA150S334N 462	105015-4620				4x0,33x150°	Nozzle
730479	NP-DLLA150S374N 464	105015-4640				2x0,34+2x0,37	Nozzle
73048	NP-DLLA150S355N 467	105015-4670				5x0,35x150°	Nozzle
730480	NP-DLLA155S324N 468	105015-4680				4x0,32x155°	Nozzle
730481	NP-DLLA150S424N 470	105015-4700				2x0,40+2x0,42	2 Springs Nozzle
73049	NP-DLLA154S304N 474	105015-4740				4x0,30x154°	Nozzle
730495	NP-DLLA150S285N 484	105015-4840				5x0,28x150°	Nozzle
73050	NP-DLLA150S424N 493	105015-4930				4x0,42x150°	Nozzle
73051	NP-DLLA103S314N 495	105015-4950				4x0,31x103°	Nozzle
73120	NP-DLLA142S354N 502	105015-5020				4x0,35x142°	Nozzle
73121	NP-DLLA133SN 504	105015-5040				5x0,36x133°	Nozzle
73122	NP-DLLA160S325N 507	105015-5070				5x0,32x160°	2 Springs Nozzle
73123	NP-DLLA155SN 515	105015-5150				5x0,30x155°	Nozzle
73124	NP-DLLA151SN 517	105015-5170				4x0,31x151°	Nozzle
73128	NP-DLLA145SN 523	105015-5230				4x0,29x145°	Nozzle
73132	NP-DLLA155SN 532	105015-5320				5x0,28x155°	Nozzle
73133	NP-DLLA154SN 533	105015-5330				4x0,37x154°	2 Springs Nozzle
73135	NP-DLLA160SN 539	105015-5390				4x0,37x160°	2 Springs Nozzle
73138	NP-DLLA148SN 545	105015-5450				4x0,37x148°	2 Springs Nozzle
73140	NP-DLLA142S344N 547	105015-5470				4x0,34x142°	2 Springs Nozzle
731401	NP-DLLA150SN 548	105015-5480				4x0,40x150°	2 Springs Nozzle
73141	NP-DLLA150SN 555	105015-5550				2x0,37+2x0,40	2 Springs Nozzle
73143	NP-DLLA160SN 564	105015-5640				5x0,29x160°	Nozzle
73145	NP-DLLA160SN 566	105015-5660				4x0,32x160°	Nozzle
73146	NP-DLLA160SN 567	105015-5670				5x0,31x160°	Nozzle
73160	NP-DLLA143SN 580	105015-5800				5x0,37x143°	2 Springs Nozzle
73161	NP-DLLA142SN 581	105015-5810				5x0,33x142°	Nozzle
73164	NP-DLLA142SN 582	105015-5820				2x0,33+2x0,35	Nozzle
73166	NP-DLLA154SN 586	105015-5860				4x0,33x154°	Nozzle
73170	NP-DLLA154SN 606	105015-6060				4x0,30x154°	Nozzle
73171	NP-DLLA154SN 607	105015-6070				4x0,32x154°	Nozzle
73173	NP-DLLA142SN 613	105015-6130				5x0,32x142°	2 Springs Nozzle
73175	NP-DLLA150SN 615	105015-6150				5x0,34x150°	2 Springs Nozzle
73177	NP-DLLA150SN 623	105015-6230				5x0,30x150°	2 Springs Nozzle
73178	NP-DLLA154SN 625	105015-6250				4x0,35x154°	2 Springs Nozzle
73180	NP-DLLA140SN 634	105015-6340				5x0,36x140°	2 Springs Nozzle
731801	NP-DLLA155SN 635	105015-6350				4x0,33x155°	Nozzle
73181	NP-DLLA158SN 638	105015-6380				5x0,30x158°	Nozzle
731812	NP-DLLA154SN 640	105015-6400				4x0,31x154°	Nozzle
731816	NP-DLLA144SN 649	105015-6490				5x0,27x144°	Nozzle
73182	NP-DLLA154SN 665	105015-6651				5x0,32x154°	2 Springs Nozzle
731821	NP-DLLA160SN 670	105015-6700				8x0,34x160°	Nozzle
731822	NP-DLLA160SN 671	105015-6710				5x0,31x160°	2 Springs Nozzle
731823	NP-DLLA152SN 681	105015-6810				5x0,36x152°	2 Springs Nozzle
731827	NP-DLLA155SN 687	105015-6870				5x0,31x155°	2 Springs Nozzle
73183	NP-DLLA148SN 693	105015-6930				4x0,37x148°	2 Springs Nozzle
73185	NP-DLLA160SN 698	105015-6980				5x0,30x160°	Nozzle
73186	NP-DLLA150SN 702	105015-7020				5x0,36x150°	2 Springs Nozzle

<i>Our Ref.</i>	<i>Stamping</i>	<i>Part Number</i>	<i>CP</i>	<i>DLC</i>	<i>D/A</i>	<i>Technical Data</i>	<i>Description</i>
<b>Zexel</b>							
73188	NP-DLLA142SN 718	105015-7180				5x0,31x142°	Nozzle
73189	NP-DLLA150SN 722	105015-7220				5x0,34x150°	Nozzle
731893	NP-DLLA155SN 727	105015-7270				5x0,30x155°	2 Springs Nozzle
73190	NP-DLLA160SN 731	105015-7310				5x0,32x160°	2 Springs Nozzle
73194	NP-DLLA153SN 736	105015-7360				5x0,30x153°	Nozzle
73195	NP-DLLA150SN 739	105015-7390				2x0,40+2x0,42	2 Springs Nozzle
73196	NP-DLLA150SN 742	105015-7420				5x0,35x150°	2 Springs Nozzle
731964	NP-DLLA160SN 744	105015-7440				5x0,31x160°	2 Springs Nozzle
73197	NP-DLLA150SN 758	105015-7580				5x0,29x150°	2 Springs Nozzle
73199	NP-DLLA150SN 762	105015-7620				5x0,32x150°	2 Springs Nozzle
73208	NP-DLLA157SN 778	105015-7780				5x0,33x157°	Nozzle
73211	NP-DLLA155SN 789	105015-7890				6X0,32x155°	2 Springs Nozzle
73221	NP-DLLA158SN 821	105015-8210				5x0,29x158°	Nozzle
732216	NP-DLLA163SN 823	105015-8230				5x0,33x163°	2 Springs Nozzle
732218	NP-DLLA160SN 827	105015-8270				5x0,30x160°	Nozzle
73223	NP-DLLA148SN 841	105015-8410				1x0,25+6x0,31	2 Springs Nozzle
732238	NP-DLLA150SN 843	105015-8430				6x0,34x150°	2 Springs Nozzle
73224	NP-DLLA160SN 844	105015-8440				5x0,33x160°	2 Springs Nozzle
73228	NP-DLLA157SN 848	105015-8480				5x0,32x157°	2 Springs Nozzle
73229	NP-DLLA158SN 852	105015-8520				8x0,29x158°	Nozzle
73230	NP-DLLA150SN 854	105015-8540				1x0,25+6x0,31	2 Springs Nozzle
732308	NP-DLLA155SN 858	105015-8580				5x0,33x155°	2 Springs Nozzle
732309	NP-DLLA150SN 859	105015-8590				5x0,27x150°	2 Springs Nozzle
732326	NP-DLLA150SN 866	105015-8660				5x0,32x150°	2 Springs Nozzle
732329	NP-DLLA150SN 868	105015-8680				5x0,29x150°	2 Springs Nozzle
73233	NP-DLLA158SN 869	105015-8690				5x0,28x158°	Nozzle
73235	NP-DLLA150SN 871	105015-8710				6x0,29x150°	2 Springs Nozzle
73237	NP-DLLA150SN 876	105015-8760				5x0,30x150°	Nozzle
732371	NP-DLLA150SN 877	105015-8770				5x0,36x150°	2 Springs Nozzle
732372	NP-DLLA158SN 878	105015-8780				8x0,27x159°	Nozzle
73239	NP-DLLA146SN 886	105015-8860				5x0,34x146°	Nozzle
73242	NP-DLLA150SN 892	105015-8920				6x0,30x150°	2 Springs Nozzle
73243	NP-DLLA160SN 893	105015-8930				5x0,27x160°	2 Springs Nozzle
73248	NP-DLLA155SN 898	105015-8980				5x0,27x155°	Nozzle
73253	NP-DLLA150SN 906	105015-9060				6x0,30x150°	2 Springs Nozzle
732535	NP-DLLA155SN 913	105015-9130				5x0,33x155°	2 Springs Nozzle
73254	NP-DLLA156SN 921	105015-9210				6x0,29x156°	2 Springs Nozzle
73255	NP-DLLA160SN 922	105015-9220				5x0,27x160°	Nozzle
73257	NP-DLLA150SN 953	105015-9530				6x0,27x150°	2 Springs Nozzle
732575	NP-DLLA155SN 955	105015-9551				6x0,31x155°	2 Springs Nozzle
73281	NP-DLLA153SN 7131	105015-7131				2x0,29+2x0,31	Nozzle
73288	NP-DLL130SM 128	105025-1280				6x0,20+6x0,27	Nozzle
732904	NP-DLLA160SM 004	105025-0040				5x0,26x160°	2 Springs Nozzle
732908	NP-DLLA145SM 012	105025-0120				6x0,33x145°	Nozzle
73291	NP-DLLA150SM 018	105025-0180				6x0,27x150°	2 Springs Nozzle
73292	NP-DLLA153SM 029	105025-0290				5x0,27x153°	Nozzle
732925	NP-DLLA152SM 043	105025-0430				6x0,27x152°	2 Springs Nozzle
732931	NP-DLLA157SM 051	105025-0510				5x0,27x157°	2 Springs Nozzle
732933	NP-DLLA158SM 053	105025-0530				5x0,29x158°	Nozzle
732934	NP-DLLA157SM 054	105025-0540				5x0,25x157°	2 Springs Nozzle
73294	NP-DLLA155SM 061	105025-0610				5x0,29x155°	Nozzle
732945	NP-DLLA152SM 070	105025-0700				6x0,31x152°	2 Springs Nozzle
732946	NP-DLLA160SM 072	105025-0720				7x0,35x160°	Nozzle
732947	NP-DLLA158SM 073	105025-0730				5x0,34x158°	2 Springs Nozzle

<i>Our Ref.</i>	<i>Stamping</i>	<i>Part Number</i>	<i>CP</i>	<i>DLC</i>	<i>D/A</i>	<i>Technical Data</i>	<i>Description</i>
<b>Zexel</b>							
73295	NP-DLLA160SM 080	105025-0800				5x0,32x160°	Nozzle
732957	NP-DLLA160SM 087	105025-0870				7x0,30x160°	Nozzle
732959	NP-DLLA142SM 095	105025-0950				5x0,29x156°	Nozzle
732968	NP-DLLA150SM 116	105025-1160				5x0,29x150°	2 Springs Nozzle
732971	NP-DLLA155SM 157	105025-1570				6x0,25x155°	2 Springs Nozzle
732975	NP-DLLA155SM 194	105025-1940				6x0,22x155°	Nozzle
732978	NP-DLLA146SM 224	105025-2240				5x0,29x146°	Nozzle
732980	NP-DLLA157SM 273	105025-2730				6x0,21x155°	Nozzle
732983	NP-DLLA150SM 303	105019-2900				5x0,28x150°	Nozzle
732984	NP-DLLA149SM 304	105025-3040				5x0,26x149°	Nozzle
732986	NP-DLLA140SM 353	105025-3530				6x0,29x140°	Nozzle
732988	NP-DLLA158SM 388	105025-3880				8x0,30x160°	Nozzle
73299	NP-DLLA156SM 420	105025-4200				7x0,22x156°	Nozzle
7329942	NP-DLLA158SM 442	105025-4420				10x0,30x158°	Nozzle
7329944	NP-DLLA158SM 454	105025-4540				8x0,23x158°	Nozzle
7329947	NP-DLLA123SM 457	105025-4570				8x0,25+4x0,19x123°	Nozzle
733019	NP-DLLA150P 9	105017-0750				4x0,31x150°	Nozzle
73303	NP-DLLA140PN 003	105017-0030				2x0,26+2x0,29	Nozzle
73304	NP-DLLA160PN 004	105017-0040				5x0,29x160°	Nozzle
73305	NP-DLLA154PN 005	105017-0051				4x0,26x154°	Nozzle
73306	NP-DLLA154PN 006	105017-0061				4x0,28x154°	Nozzle
73307	NP-DLLA154PN 007	105017-0070				5x0,27x154°	Nozzle
73309	NP-DLLA152PN 009	105017-0090				4x0,30x152°	Nozzle
73310	NP-DLLA160PN 010	105017-0100				5x0,30x160°	Nozzle
73313	NP-DLLA140PN 013	105017-0130				2x0,27+2x0,29	Nozzle
73314	NP-DLLA152PN 014	105017-0140				4x0,29x152°	Nozzle
73318	NP-DLLA154PN 018	105017-0181				4x0,25x154°	Nozzle
73321	NP-DLLA150PN 021	105017-0210				4x0,34x150°	Nozzle
73325	NP-DLLA154PN 025	105017-0250				4x0,32x154°	Nozzle
73331	NP-DLLA160PN 031	105017-0310				3x0,30+2x0,32	Nozzle
73336	NP-DLLA160PN 036	105017-0360				5x0,30x160°	Nozzle
73344	NP-DLLA150PN 044	105017-0440				4x0,30x150°	2 Springs Nozzle
73349	NP-DLLA154PN 049	105017-0490				4x0,26x154°	Nozzle
73355	NP-DLLA146PN 055	105017-0550				4x0,30x146°	Nozzle
73356	NP-DLLA150PN 056	105017-0560				4x0,29x150°	Nozzle
73357	NP-DLLA155PN 057	105017-0570				3x0,26+2x0,29	Nozzle
73358	NP-DLLA154PN 058	105017-0580				4x0,30x154°	Nozzle
73361	NP-DLLA154PN 061	105017-0610				4x0,31x154°	Nozzle
73362	NP-DLLA154PN 062	105017-0620				4x0,29x154°	Nozzle
73364	NP-DLLA154PN 064	105017-0640				4x0,32x154°	Nozzle
73367	NP-DLLA154PN 067	105017-0670				4x0,26x154°	Nozzle
73368	NP-DLLA154PN 068	105017-0680				4x0,29x154°	Nozzle
73385	NP-DLLA160PN 085	105017-0850				5x0,28x160°	Nozzle
73386	NP-DLLA151PN 086	105017-0861				4x0,30x151°	Nozzle
73387	NP-DLLA154PN 087	105017-0870				4x0,28x154°	Nozzle
73388	NP-DLLA150PN 088	105017-0880				5x0,28x150°	Nozzle
73404	NP-DLLA158PN 104	105017-1040				5x0,31x158°	Nozzle
73409	NP-DLLA161PN 109	105017-1090				4x0,33x161°	2 Springs Nozzle
73416	NP-DLLA154PN 116	105017-1160				4x0,24x154°	Nozzle
73418	NP-DLLA155PN 118	105017-1180				4x0,31x155°	Nozzle
73421	NP-DLLA156PN 121	105017-1210				4x0,31x153°	Nozzle
73423	NP-DLLA155PN 123	105017-1230				4x0,30x155°	Nozzle
73435	NP-DLLA160PN 135	105017-1350				5x0,28x160°	Nozzle
73441	NP-DLLA160PN 141	105017-1410				5x0,30x160°	Nozzle

<i>Our Ref.</i>	<i>Stamping</i>	<i>Part Number</i>	<i>CP</i>	<i>DLC</i>	<i>D/A</i>	<i>Technical Data</i>	<i>Description</i>
<b>Zexel</b>							
73459	NP-DLLA160PN 159	105017-1590				5x0,28x156°	Nozzle
73461	NP-DLLA154PN 161	105017-1610				4x0,25x154°	Nozzle
73477	NP-DLLA153PN 177	105017-1770				5x0,25x153°	Nozzle
73478	NP-DLLA153PN 178	105017-1780				5x0,25x153°	Nozzle
73479	NP-DLLA155PN 179	105017-1790				4x0,31x155°	Nozzle
73485	NP-DLLA154PN 185	105017-1850				5x0,29x154°	Nozzle
73486	NP-DLLA154PN 186	105017-1860				5x0,27x154°	Nozzle
73509	NP-DLLA158PN 209	105017-2090	CP			5x0,21x158°	Nozzle
73510	NP-DLLA146PN 218	105017-2181	CP			6x0,23x146°	2 Springs Nozzle
735105	NP-DLLA146PN 220	105017-2200	CP			5x0,285x146°	Nozzle
735108	NP-DLLA152PN 232	105017-2320	CP			5x0,22x152°	2 Springs Nozzle
73511	NP-DLLA145PN 238	105017-2380	CP			5x0,215x145°	2 Springs Nozzle
73515	NP-DLLA143PN 265	105017-2650	CP			5x0,22x143°	2 Springs Nozzle
73517	NP-DLLA154PN 270	105017-2700	CP			5x0,205x154°	2 Springs Nozzle
73519	NP-DLLA155PN 276	105017-2760	CP			5x0,25x155°	Nozzle
73526	NP-DLLA148PN 306	105017-3060	CP			6x0,19x148°	2 Springs Nozzle
73529	NP-DLLA144PN 309	105017-3090	CP			5x0,22x144°	2 Springs Nozzle
73532	NP-DLLA150PN 315	105017-3150				5x0,29x160°	Nozzle
73535	NP-DLLA143PN 325	105019-1470	CP			5x0,23x143°	2 Springs Nozzle
73537	NP-DLLA148PN 345	105017-3450	CP			5x0,23x148°	Nozzle
73538	NP-DLLA145PN 357	105017-3570	CP			5x0,185x145°	Nozzle
73554	NP-DSLA154PN 114	105017-1140				4x0,30x154°	2 Springs Nozzle
73563	NP-DSLA149PN 903	105017-9030	CP			5x0,26x149°	Nozzle
NZX10128	DL130T328NP20	105011-9260				8x0,32x130°	Nozzle
NZX10162	DL150T268NP22	105011-9340				8x0,26x150°	Nozzle
NZX10168	DL150T288NP22	105011-9330				8x0,28x150°	Nozzle
NZX10178	DL150T348NP20	105011-9270				8x0,34x150°	Nozzle
NZX10184	DL150T388NP20	105011-9250				8x0,38x150°	Nozzle
NZX10187	DL155T308NP26	105011-9500				8x0,30x155°	Nozzle
NZX10189	DL155T3110NP34	105018-0220				10x0,31x155°	Nozzle
NZX10190	DL155T3310NP40					10x0,33x155°	Nozzle
NZX10192	DL155TE3710N8	105018-0521/0522				10x0,37x155°	Nozzle
NZX10194	DL155TE3910N8					10x0,39x155°	Nozzle
NZX101945	DL158TE2710N12						Nozzle
NZX10195	DL158TE3110N14					10x0,31x158°	Nozzle
NZX10196	DL160T306NP1	105011-2310				6x0,30x160°	Nozzle
NZX10197	DL160T3110NP47E	105018-0880				10x0,33x160°	Nozzle
NZX10199	DL160T3310NP34	105018-0470				10x0,33x160°	Nozzle
NZX10203	DL160T32510NP40	105018-0480				10x0,325x160°	Nozzle
NZX10205	DL160T3510NP40	105018-0450				10x0,35x160°	Nozzle
NZX10214	DL145TE324.284N4	105018-0290				4x0,28+4x0,32	Nozzle
NZX12228	DL150U428NP9	105012-0570				8x0,42x150°	Nozzle
NZX12980	DLL137TE2610					10x0,26x137°	Nozzle
NZX12989	DLL135TE2810					10x0,28x135°	Nozzle
NZX12990	DLL137TE2810					10x0,28x137°	Nozzle
NZX12991	DLL140TE2810					10x0,28x140°	Nozzle
NZX12993	DLL137TE3010					10x0,30x137°	Nozzle
NZX12994	DLL140TE3010					10x0,30x140°	Nozzle
NZX12996	DLL137TE3210					10x0,32x137°	Nozzle
NZX12997	DLL140TE3210					10x0,32x140°	Nozzle
NZX12998	DLL135TE288					8x0,28x135°	Nozzle
NZX13000	DLL140TE288	105016-1530/1531				8x0,28x140°	Nozzle
NZX14038	DLL137UE3810N3					10x0,38x137°	Nozzle
NZX140381	DLL140UE3810					10x0,38x140°	Nozzle

<i>Our Ref.</i>	<i>Stamping</i>	<i>Part Number</i>	<i>CP</i>	<i>DLC</i>	<i>D/A</i>	<i>Technical Data</i>	<i>Description</i>
<b>NZX14039</b>	DLL140UE3412N3					12x0,34x140°	Nozzle
<b>NZX14040</b>	DLL140UE4010N2					10x0,40x140°	Nozzle
<b>NZX14042</b>	DLL140UE4210N2					10x0,42x140°	Nozzle
<b>NZX14044</b>	DLL140UE4410N2					10x0,44x140°	Nozzle
<b>NZX14046</b>	DLL140UE4610N2					10x0,46x140°	Nozzle
<b>NZX14047</b>	DLL140UE4810					10x0,48x140°	Nozzle
<b>NZX14048</b>	DLL150UE4810					10x0,48x150°	Nozzle
<b>NZX15202</b>	DLF130TB328N17	105011-7240				8x0,32x130°	Nozzle
<b>NZX15204</b>	DLF140TB304-264N3	105011-7980				4x0,30/4x0.26x140°	Nozzle
<b>NZX15218</b>	DLF145TB308N20	105011-7360				8x0,30x145°	Nozzle
<b>NZX15220</b>	DLF148TB338					8x0,33x148°	Nozzle
<b>NZX15221</b>	DLF145TB328	105011-6130				8x0,32x145°	Nozzle
<b>NZX15223</b>	DLF150TB268	105011-7680				8x0,26x150°	Nozzle
<b>NZX15228</b>	DLF150TB308	105011-6010				8x0,30x150°	Nozzle
<b>NZX15238</b>	DLF150TB328N23 C	105011-7450				8x0,32x150°	Nozzle
<b>NZX15250</b>	DLF150TB348N17	105011-7260				8x0,34x150°	Nozzle
<b>NZX15268</b>	DLF150TB368N27	105011-7740				8x0,36x150°	Nozzle
<b>NZX15289</b>	DLF150TB388N17	105011-7250				8x0,38x150°	Nozzle
<b>NZX15306</b>	DLF160TB306N8	105011-6640				6x0,30x160°	Nozzle
<b>NZX15320</b>	DLF137TE3010					10x0,30x137°	Nozzle
<b>NZX15336</b>	DLF140TE2610	105011-8450/8451				10x0,26x140°	Nozzle
<b>NZX15340</b>	DLF140TE2810	105011-8460/8461				10x0,28x140°	Nozzle
<b>NZX15344</b>	DLF140TE3010	105011-8470/8471				10x0,30x140°	Nozzle
<b>NZX15347</b>	DLF140TE3210	105011-8480/8481				10x0,32x140°	Nozzle
<b>NZX15358</b>	DLF145TE308N1 C	105011-8090				8x0,30x145°	Nozzle
<b>NZX15362</b>	DLF145TE284.264N3C					4x0,28+4x0,26	Nozzle
<b>NZX15364</b>	DLF145TE324.284N3C	105011-8200				4x0,32+4x0,28	Nozzle
<b>NZX15370</b>	DLF145TE328N1	105011-8110				8x0,32x145°	Nozzle
<b>NZX15380</b>	DLF145TE348					8x0,34x145°	Nozzle
<b>NZX16048</b>	DLF140UB4810	105012-6240/6241				10x0,48x140°	Nozzle
<b>NZX16052</b>	DLF140UB5210	105012-6270/6271				10x0,52x140°	Nozzle
<b>NZX16079</b>	DLF150UB479N9	105012-5630				9x0,47x150°	Nozzle
<b>NZX16152</b>	DLF140UB529					9x0,52x140°	Nozzle
<b>NZX16238</b>	DLF137UE3810N8 C	105012-6280				10x0,38x137°	Nozzle
<b>NZX16340</b>	DLF140UE4010N3					10x0,40x140°	Nozzle
<b>NZX163401</b>	DLF150UE4010N3C					10x0,40x150°	Nozzle
<b>NZX16342</b>	DLF150UE4210N3C					10x0,42x150°	Nozzle
<b>NZX16344</b>	DLF150UE4410N3C	105012-6320/6321				10x0,44x150°	Nozzle
<b>NZX17561</b>	DLF145VE5611N4	105013-4291				11x0,56x145°	Nozzle

**PRODUCT UPDATE - September 2010 (last update 16.03.2026)**



## Nozzles and spare parts for DENSO® COMMON RAIL INJECTORS AND PUMPS suitable for many European and Japanese vehicles

In late 1995, Denso® launched its first common rail system and it continues to develop and improve it. In fact Denso® introduced in the European market in June 2002 a 1800-bar common rail system. Denso®'s Common Rail system achieved a high injection pressure and five-time multiple injections at a high accuracy. This system comfortably cleared Euro 4/5 emission regulations without a diesel particulate filter.

In Europe, many vehicles like Primera, Almera, Tino, and X-Trail of Nissan®, MPV and Mazda 6 of Mazda® and Avensis of Toyota® are equipped with this system.

In Japan and in many other countries Hilux and Prado of Toyota® and pickups DMAX and light truck ELF of Isuzu® are equipped with this system.

We produce over 140 different nozzles.

Check out in next pages our Common Rail products suitable for Denso®.



## NOZZLES

Seven Code	Stamping	Part Number	DLC	Injector No.	Main Applications
73810	ND-DLLA155P 683	093400-6830			
738103	ND-DLLA144P 690	093400-6900	DLC	095000-014X 095000-019X	Isuzu 6HK1 and F-Series Truck
738108	ND-DLLA149P 703	093400-7030	DLC	095000-016X	Isuzu 8-94392862-#
73811	ND-DLLA155P 706	093400-7060	DLC		
738121	ND-DLLA154P 717	093400-7170	DLC		
73815	ND-DLLA144P 720	093400-7200	DLC		
73817	ND-DLLA147P 747	093400-7470	DLC	095000-042X 095000-057X	Toyota Avensis, Avensis Verso, Previa II and RAV 4 II 23670-27030 (042) 23670-29035 (057)
73818	ND-DLLA145P 748	093400-7480	DLC		
738189 ••	ND-DLLA147P 752	093400-7520	DLC	095000-043X 095000-064X	Toyota Corolla 23670-27020 (043) 23670-27025 (064)
73819	ND-DLLA155P 753	093400-7530	DLC	095000-053X 095000-075X	Toyota Land Cruiser (Prado / Colorado) 23670-30020 (053) 23670-39025 (075)
73821	ND-DLLA143P 761	093400-7610		095000-056X	Komatsu 6218113100/01/10
73822	ND-DLLA147P 762	093400-7620	DLC	095000-061X	Kobelco BM800 and Hino 500 Series with Hino P11C engine
73823	ND-DLLA148P 763	093400-7630	DLC	095000-054X	John Deere 8.1L RE504181
73824	ND-DLLA148P 764	093400-7640	DLC	095000-055X	John Deere 8.1L RE501010
738241	ND-DLLA148P 765	093400-7650	DLC	095000-051X	Nissan X-Trail 16600-8H80#
738251	ND-DLLA147P 788	093400-7880	DLC	095000-077X 095000-094X	Toyota Dyna, Hiace III, IV, V and Hilux II III 23670-30030 (077) 23670-39035 (094)
73829	ND-DLLA142P 793	093400-7930	DLC	095000-080X	
73830	ND-DLLA152P 798	093400-7980	DLC	095000-501X	Isuzu 4HJ1 8-97306073-#
73831	ND-DLLA156P 799	093400-7990	DLC	095000-500X 095000-550X	Isuzu 8-97306071-# (500) 8-97367552-# (550)

DLC (Diamond-Like Carbon) = needle with special black coating



## NOZZLES

Seven Code	Stamping	Part Number	DLC	Injector No.	Main Applications
73832 ••	ND-DLLA148P 800	093400-8000	DLC		Nissan Primera
73835	ND-DLLA152P 805	093400-8050	DLC	095000-503X 095000-587X 095000-785X 095000-883X	Mazda 6 and MPV II RF5C13H50A (503) RF5C13H50B (587) RFY013H50A (883) RFY013H50B (785)
738371	ND-DLLA155P 807	093400-8070	DLC		Toyota 23670-30060
73838	ND-DLLA133P 814	093400-8140	DLC	095000-505X	John Deere 4.5L/6.8L RE516540-RE519730 RE507860
73839	ND-DLLA150P 815	093400-8150	DLC	095000-512X 095000-542X	Toyota Avensis and Corolla 23670-0G010 (512) 23670-09030 (542)
738395	ND-DLLA148P 816	093400-8160	DLC	095000-507X 095000-513X	Nissan Almera, Primera and X-Trail 16600-AW42# (507) 16600-AW40# (513)
738401	ND-DLLA148P 817	093400-8170	DLC	095000-508X	Opel Astra, Combo, Corsa and Meriva 8-97313861-#
738402	ND-DLLA148P 820	093400-8200	DLC	095000-516X	John Deere 8.1L RE518725-RE524362 RE504181
738403	ND-DLLA148P 821	093400-8210	DLC		
738404 ••	ND-DLLA148P 824	093400-8240	DLC	095000-517X 095000-518X	Nissan Almera and Primera 16600-BN82# (517) 16600-BN80# (518)
738405	ND-DLLA148P 826	093400-8260	DLC	095000-519X	John Deere 8.1L RE524364-RE518723
738406	ND-DLLA148P 828	093400-8280	DLC	095000-523X	John Deere 8.1L RE524360
738409	ND-DLLA158P 834	093400-8340	DLC	095000-522X	Hino 700-Series 23670-E0341
73841 •	ND-DLLA150P 835	093400-8350	DLC	095000-521X	Hino P11C 23670-E0351
738417 •	ND-DLLA155P 840	093400-8400	DLC	095000-655X	Toyota/Hino 23670-78140
73842	ND-DLLA155P 842	093400-8420	DLC	095000-659X	Hino J08/New Holland 23670-E0010
738431	ND-DLLA158P 844	093400-8440	DLC	095000-534X	Isuzu Forward 8-97602485-# (534)



## NOZZLES

Seven Code	Stamping	Part Number	DLC	Injector No.	Main Applications
73844	ND-DLLA155P 848	093400-8480	DLC	095000-635X	Kobelco SK200-8 and SK260-8 23670-E0050
738450	ND-DLLA139P 851	093400-8510	DLC	095000-548X	John Deere 4.5L RE520240-RE520333
738451	ND-DLLA142P 852	093400-8520	DLC	095000-121X	Komatsu 6156113300
7384541	ND-DLLA158P 854	970950-0547	DLC	095000-547X	Isuzu 4HK1/6HK1 8-97329703-#
73846	ND-DLLA157P 855	093400-8550	DLC	095000-545X	Mitsubishi 6M60
73847	ND-DLLA155P 856	093400-8560	DLC	095000-660X	Hino 500 Series or Ranger 23670-E0040 23670-E0041
7384911 •	ND-DLLA152P 862	093400-8620	DLC	095000-543X 095000-610X	Isuzu DMAX 8-97311372-# (543) 8-98011604-# (610) 8-98055862-# (610)
7384931	ND-DLLA155P 863	093400-8630	DLC	095000-544X 095000-592X	Toyota Hilux III, Toyota Land Cruiser (Prado) and Hiace 23670-0L020 (544) 23670-09070 (592)
7384941	ND-DLLA145P 864	093400-8640	DLC	095000-552X 095000-588X 095000-593X	Toyota Hilux 2.5L 23670-09060 (593) 23670-0L010 (552) 23670-30050 (588)
7384951	ND-DLLA152P 865	093400-8650	DLC		
738496	ND-DLLA150P 866	093400-8660	DLC	095000-555X 095000-831X	Hyundai County and Mighty 33800-4570#
7384971	ND-DLLA145P 870	093400-8700	DLC	095000-560X	Mitsubishi L200 and Pajero Sport II 1465A041
738498 •	ND-DLLA148P 872	093400-8720	DLC	095000-565X	Nissan Navara D40 and Pathfinder 16600-EB30#
7384991 •	ND-DLLA145P 875	093400-8750	DLC	095000-576X 095000-811X	Mitsubishi L, Pajero IV and Montero 1465A054 (576) 1465A307 (811)
7384992	ND-DLLA155P 876	093400-8760	DLC	095000-604X 095000-623X	USE P1028 23670-0R020 (604) 23670-09140 (623)



## NOZZLES

Seven Code	Stamping	Part Number	DLC	Injector No.	Main Applications
<b>7384999</b>	ND-DLLA155P 880	093400-8800	DLC	095000-676X 095000-703X 095000-740X 095000-741X	USE P1025 Toyota Hilux 23670-30140 (676) 23670-39185 (703) 23670-30220 (740) 23670-39215 (741)
<b>73850</b>	ND-DLLA154P 881	093400-8810	DLC	095000-578X 095000-786X	Mazda 3, 5 and 6 RF7J13H50 (578) RF8G13H50 (786)
<b>738510</b>	ND-DLLA153P 884	093400-8840	DLC	095000-580X	Citroen Jumper, FIAT Ducato, Ford Transit and Tourneo, Peugeot Boxer 6C1Q9K546AC (580) 1980J7 (580) 71794621 (580) 71724128 (580)
<b>738511</b> •	ND-DLLA153P 885	093400-8850	DLC	095000-581X 095000-706X	Ford Transit and Tourneo, Land Rover Defender 6C1Q9K546BB (581) 6C1Q9K546BC (706)
<b>73852</b>	ND-DLLA139P 887	093400-8870	DLC	095000-649X	John Deere 4.5L/6.8L RE546781-RE524382 RE529118
<b>73853</b>	ND-DLLA125P 889	093400-8890	DLC	095000-648X	John Deere 9.0L RE546776-RE528407 RE529149
<b>73854</b>	ND-DLLA129P 890	093400-8900	DLC	095000-647X	John Deere 9.0L RE546777-RE528408 RE529151
<b>738551</b>	ND-DLLA156P 905	093400-9050	DLC		
<b>73856</b>	ND-DLLA150P 906	093400-9060	DLC		
<b>738565</b>	ND-DLLA158P 909	093400-9090	DLC	095000-597X	Toyota Dyna 200 23670-E0360-A
<b>738571</b> •	ND-DLLA148P 915	093400-9150	DLC	095000-607X	Komatsu 6251-11-3100
<b>7385713</b>	ND-DLLA152P 917	093400-9170	DLC	095000-602X	Nissan X-Trail 16600-ES60# 16600-ES61#
<b>7385714</b> ••	ND-DLLA138P 919	093400-9190	DLC	095000-612X	Komatsu engine SAA6D140E-5 6261-11-3100
<b>7385715</b>	ND-DLLA148P 924	093400-9240	DLC	095000-613X	Opel Astra, Corsa, Meriva and Zafira 8-97376270-#



## NOZZLES

Seven Code	Stamping	Part Number	DLC	Injector No.	Main Applications
<b>7385717</b>	ND-DLLA139P 925	093400-9250	DLC	095000-650X	John Deere 4.5L/6.8L RE546782-RE529117 RE529414
<b>738581</b>	ND-DLLA150P 927	093400-9270	DLC	095000-594X 095000-622X	Wuxi Diesel 6DL1
<b>738582</b>	ND-DLLA152P 929	093400-9290	DLC	095000-630X	Isuzu N-Series 15.7L 1-15300436-0
<b>7385831</b> •	ND-DLLA148P 932	093400-9320	DLC	095000-624X	Nissan Cabstar 16600-MB40#
<b>738589</b>	ND-DLLA155P 939	093400-9390	DLC	095000-641X 095000-696X 095000-730X 095000-731X 095000-766X 095000-767X	Toyota Avensis 23670-0R030 (641) 23670-09180 (696) 23670-0R140 (730) 23670-09240 (731) 23670-0R190 (766) 23670-09280 (767)
<b>738590</b> •	ND-DLLA155P 941	093400-9410	DLC	095000-847X	Toyota Dyna 200 23670-E0410 23670-78160
<b>738591</b>	ND-DLLA127P 944	093400-9440	DLC	095000-631X	John Deere 4.5L/6.8L RE546784-RE530362 RE531209
<b>738592</b> •	ND-DLLA127P 945	093400-9450	DLC	095000-632X	John Deere 4.5L/6.8L RE546783-RE530361 RE531210
<b>738593</b>	ND-DLLA152P 947	093400-9470	DLC	095000-625X	Nissan Navara D40, NP300 and Pathfinder 16600-EC00#
<b>7385951</b>	ND-DLLA151P 955	093400-9550	DLC	095000-662X	Ford Transit 3.2L 7C169K546AB
<b>738605</b> •	ND-DLLA155P 960	093400-9600	DLC	095000-768X 095000-769X	Toyota Avensis, Auris, Corolla, Corolla Verso and RAV4 23670-0R180 (768) 23670-09270 (769)
<b>738609</b>	ND-DLLA155P 964	093400-9640	DLC	095000-679X	Shanghai Diesel 6114
<b>738611</b>	ND-DLLA155P 965	093400-9650	DLC	095000-670X	Sino Truck Howo
<b>738621</b>	ND-DLLA150P 966	093400-9660	DLC		USE P1026
<b>73865</b>	ND-DLLA155P 970	093400-9700	DLC	095000-753X	Toyota Land Cruiser 200 23670-59025 (753)



## NOZZLES

Seven Code	Stamping	Part Number	DLC	Injector No.	Main Applications
<b>73866</b>	ND-DLLA155P 971	093400-9710	DLC	095000-674X 095000-718X 095000-805X 095000-806X 095000-974X 095000-977X	Toyota Land Cruiser 23670-51040 (805) 23670-51041 (974) 23670-59016 (806) 23670-59018 (977)
<b>73867</b>	ND-DLLA153P 977	093400-9770	DLC	095000-708X	
<b>73870</b>	ND-DLLA152P 980	093400-9800	DLC	095000-698X	Isuzu DMAX 8-98011604-#
<b>73871</b>	ND-DLLA152P 981	093400-9810	DLC	095000-699X	Isuzu DMAX 8-98011605-#
<b>738712</b>	ND-DLLA129P 983	093400-9830	DLC	095000-688X	John Deere 4.5L/6.8L RE546780-RE532216 RE531210
<b>738713</b>	ND-DLLA158P 984	093400-9840	DLC	095000-637X	Isuzu 8-97609789-#
<b>738714</b> ●●	ND-DLLA155P 985	093400-9850	DLC	095000-574X 095000-589X	Toyota Land Cruiser 23670-30080 (574) 23670-39135 (589)
<b>73872</b>	ND-DLLA152P 989	093400-9890	DLC	095000-714X (9709500-714)	Hyundai Mighty, Mega Truck and County 33800-52000
<b>73873</b>	ND-DLLA150P 991	093400-9910	DLC	095000-717X	Hino 23670-E0370
<b>73875</b>	ND-DLLA150P 1023	093400-1023	DLC	095000-755X 095000-758X	Toyota Avensis and Corolla 23670-0G040 (755) 23670-09250 (758)
<b>73876</b>	ND-DLLA145P 1024	093400-1024	DLC	095000-738X 095000-775X 095000-776X 095000-853X 095000-874X	Toyota Hilux 2.5L D-4D 23670-30240 (738) 23670-30300 (775) 23670-39275 (776) 23670-0L070 (853) 23670-09360 (874)
<b>738761</b>	ND-DLLA155P 1025	093400-1025	DLC	095000-754X 095000-773X 095000-778X	Toyota Hilux III and Land Cruiser (Prado) 23670-30280 (754) 23670-39295 (773) 23670-39315 (778) 23670-39316 (778)
<b>7387615</b>	ND-DLLA150P 1026	093400-1026	DLC	095000-779X 095000-780X	Toyota Hiace 23670-30310 (779) 23670-39285 (780)



## NOZZLES

Seven Code	Stamping	Part Number	DLC	Injector No.	Main Applications
<b>7387616</b>	ND-DLLA155P 1027	093400-1027	DLC	095000-561X 095000-611X 095000-690X 095000-724X 095000-725X 095000-760X 095000-761X	Toyota Avensis 23670-0R010 (561) 23670-09130 (611) 23670-0R110 (724) 23670-09200 (725) 23670-0R160 (760) 23670-09260 (761)
<b>738762</b>	ND-DLLA155P 1028	093400-1028	DLC	095000-763X 095000-764X	Toyota Corolla Verso and RAV4 III 23670-0R170 (763) 23670-09290 (764)
<b>7387629</b>	ND-DLLA155P 1030	093400-1030	DLC	095000-749X 095000-956X	Mitsubishi L200 and Pajero 1465A257 (956) 1465A297 (749)
<b>738763</b>	ND-DLLA145P 1031	093400-1031	DLC	095000-750X	Mitsubishi Pajero 1465A279
<b>738764</b>	ND-DLLA149P 1036	093400-1036	DLC	095000-515X 095000-756X	John Deere 8.1L RE518726 (515) RE524361 (756) RE535961 (756)
<b>738766</b>	ND-DLLA152P 1040	093400-1040	DLC	095000-837X	Isuzu 8-98119228-#
<b>738768</b>	ND-DLLA155P 1044	093400-1044	DLC	095000-652X	Toyota Dyna 200 23670-79026 23670-E0091
<b>73877</b>	ND-DLLA145P 1049	093400-1049	DLC	095000-801X	Sino Truck Howo
<b>73881</b>	ND-DLLA150P 1052	093400-1052	DLC	095000-810X	Sino Truck
<b>738813</b>	ND-DLLA150P 1054	093400-1054	DLC	095000-681X	Hino 23670-E0201
<b>738817</b> •	ND-DLLA150P 1059	093400-1059	DLC		Hyundai
<b>73882</b>	ND-DLLA155P 1062	093400-1062	DLC	095000-822X 095000-829X	Toyota Hilux III and Land Cruiser (Prado) 23670-0L050 (822) 23670-09330 (829)
<b>73890</b>	ND-DLLA155P 1090	093400-1090	DLC	095000-679X	LiuGong, SDLG, Shantui and XCMG
<b>73892</b> •	ND-DLLA158P 1092	093400-1092	DLC	095000-636X	Isuzu Forward 8-97609788-# (636)
<b>73896</b> •	ND-DLLA158P 1096	093400-1096	DLC	095000-890X	Isuzu N-Series 8-98151837-# (890)
<b>738961</b>	ND-DLLA152P 1097	093400-1097	DLC	095000-551X	Isuzu 6WF1-TC 8-97603415-#
<b>73905</b> ••	ND-DLLA152P 1115	093400-1115	DLC	095000-803X	Isuzu D-Max 3.0 d 8-98074909-0



## NOZZLES

Seven Code	Stamping	Part Number	DLC	Injector No.	Main Applications
73959	G3S1		DLC	295050-001X	Mazda 3, 6 and CX7 R2AA13H50
73960	G3S3		DLC	295050-005X	Chevrolet Cruze and Trax, Opel Astra 1.7L, Corsa, Meriva and Mokka 821005 55567729
739601 ●●	G3S4		DLC	295050-012X	Citroen C4 Aircross, Peugeot 4008, Mitsubishi ASX, Lancer and Outlander 16 078 541 80 1465A323
73961	G3S6		DLC	295050-018X 295050-020X 295050-046X 295050-052X	Toyota Hilux 23670-0L090 (018) 23670-30400 (020) 23670-39365 (046) 23670-09350 (052)
73962	G3S7		DLC	295050-019X 295050-021X 295050-047X 295050-053X	Toyota Hiace 23670-0L100 (019) 23670-30410 (021) 23670-39255 (047) 23670-09340 (053)
739621 ●●	G3S8		DLC	DCRI300250 295050-025X	Subaru 16613-AA030
73963 ●	G3S10		DLC	DCRI300300 295050-030X	Nissan Navara, Murano and Pathfinder 16600-5X00# 16600-1AT0A
739632 ●●	G3S12		DLC	295050-023X	Hino 23670-E0400
73964	G3S16		DLC	295050-033X	Perkins C4.4 and C7.1 3425761
73965	G3S17		DLC	259050-061X	John Deere 9.0L RE543605 RE543352
739659 ●●	G3S21		DLC	295050-038X	Xichai
73966 ●●	G3S22		DLC	295050-040X	Perkins C6.6 3425-763
739667 ●●	G3S29		DLC	295050-171X	Isuzu NLR 8-98238318-1



## NOZZLES

Seven Code	Stamping	Part Number	DLC	Injector No.	Main Applications
73967 •	G3S32		DLC	295050-056X	Mitsubishi Pajero/Montero 1465A351
73968	G3S33		DLC	295050-054X 295050-081X	Toyota Dyna 23670-0L110 (054) 23670-09380 (081)
739685 •	G3S41		DLC	295050-076X	Hino 300 23670-E9260
739686 ••	G3S42		DLC	295050-079X	Hino 23670-E0530
73969	G3S45		DLC	295050-089X	Mitsubishi L200 and Pajero Sport 1465A367
739691 ••	G3S46		DLC	295050-090X	Nissan Cabstar 16600-5X00#
739692	G3S47		DLC	295050-091X 295050-190X	Isuzu D-Max 2.5L 8-98159583-0 (091) 8-98260109-0 (190)
739695	G3S48		DLC	295050-093X	Isuzu and Qingling 8-98178247-3
73970	G3S49		DLC		
739701	G3S50		DLC	295050-096X	Toyota Vigo (Hilux)
739702 •	G3S51		DLC	295050-105X	Nissan Frontier 2.5L 16600-5X30A
739703	G3S52		DLC	295050-106X	Nissan Navara, NP300 and Pathfinder 16600-3XN0#
739704	G3S53		DLC	5296723	Foton Cummins ISF3.8 Euro IV
739705 •	G3S54		DLC	295050-117X	Hino J08E 23670-E0031
73972	G3S58		DLC	295050-124X	Volvo Penta 21785960
73973	G3S60		DLC	295050-129X	Isuzu NPR, Novociti, Novolux, Novo, Novo Ultra and Turkuaz 8-98207435-0
73974 ••	G3S62		DLC	295050-116X	Caterpillar
739741 ••	G3S63		DLC		
73975	G3S69		DLC		
73976 ••	G3S72		DLC	295050-143X	John Deere



## NOZZLES

Seven Code	Stamping	Part Number	DLC	Injector No.	Main Applications
739762 ●●	G3S74		DLC	295050-146X	Xichai
73977	G3S77		DLC	295050-176X	Mitsubishi L200 1465A439
73979 ●●	G3S79		DLC	295050-159X	Toyota 23670-E0590
73981	G3S81		DLC		
73983	G3S87		DLC		
73990 ●●	G3S112		DLC	9729505-220X	Cummins 5344766
73995 ●●	G3S126		DLC	295050-248X	Isuzu D-Max 8-98331847-1
73996 ●●	G3S132		DLC	295050-345X	
73G411 ●●	G4S011		DLC	295700-014X DCRI400140	Hyundai H1 33800-4A900
73G411K ●●	G4S011	KIT	DLC	295700-014X DCRI400140	Hyundai H1 33800-4A900
73G412 ●●	G4S012		DLC	295700-021X DCRI400210 295700-040X DCRI400400	Mazda 2, 3 and CX3 S550-13H50
73G412K ●●	G4S012	KIT	DLC	295700-021X DCRI400210 295700-040X DCRI400400	Mazda 2, 3 and CX3 S550-13H50



## CONTROL VALVES AND PLUNGERS



Injector No.	Control Valve Seven Code	Plunger Seven Code
095000-036X	<b>12036 *</b>	<b>14036</b>
095000-042X	<b>12042 *</b>	<b>14042</b>
095000-043X	<b>12043 *</b>	<b>14043</b>
095000-051X	<b>12051 *</b>	-
095000-052X	<b>12052 *</b>	<b>14052</b>
095000-053X	<b>12053 *</b>	<b>14053</b>
095000-057X	<b>12057 *</b>	<b>14057</b>
095000-063X	<b>12063 *</b>	<b>14063</b>
095000-064X	<b>12064 *</b>	<b>14064</b>
095000-074X	<b>12074 *</b>	<b>14074</b>
095000-075X	<b>12075 *</b>	<b>14075</b>
095000-077X	<b>12077 *</b>	<b>14077</b>
095000-088X	<b>12088 *</b>	<b>14088</b>
095000-094X	<b>12094 *</b>	<b>14094</b>
095000-095X	<b>12095 *</b>	<b>14095</b>
095000-505X	<b>12505</b>	-
095000-508X	<b>12508</b>	<b>14508</b>
095000-512X	<b>12512</b>	<b>14512</b>
095000-513X	<b>12513</b>	<b>14513</b>
095000-521X	<b>12521</b>	<b>14521</b>
095000-522X	<b>12522</b>	<b>14522</b>
095000-534X	<b>12534</b>	<b>14534</b>
095000-544X	<b>12544</b>	<b>14544</b>
095000-547X	<b>12547</b>	<b>14547</b>
095000-548X	<b>12548</b>	<b>14548</b>
095000-551X	<b>12551</b>	<b>14551</b>
095000-555X	<b>12555</b>	<b>14555</b>

Injector No.	Control Valve Seven Code	Plunger Seven Code
095000-560X	<b>12560</b>	<b>14560</b>
095000-565X	<b>12565</b>	<b>14565</b>
095000-576X	<b>12576</b>	<b>14576</b>
095000-578X	<b>12578</b>	<b>14578</b>
095000-580X	<b>12580</b>	<b>14580</b>
095000-592X	<b>12592</b>	<b>14592</b>
095000-593X	<b>12593</b>	<b>14593</b>
095000-602X	<b>12602</b>	<b>14602</b>
095000-604X	<b>12604</b>	-
095000-613X	<b>12613</b>	<b>14613</b>
095000-623X	<b>12623</b>	<b>14623</b>
095000-624X	<b>12624</b>	<b>14624</b>
095000-625X	<b>12625</b>	<b>14625</b>
095000-631X	<b>12631</b>	<b>14631</b>
095000-632X	<b>12632</b>	-
095000-635X	<b>12635</b>	<b>14635</b>
095000-641X	<b>12641</b>	-
095000-649X	<b>12649</b>	-
095000-650X	<b>12650</b>	<b>14650</b>
095000-652X	<b>12652</b>	-
095000-659X	<b>12659</b>	-
095000-670X	<b>12670</b>	-
095000-676X	<b>12676</b>	<b>14676</b>
095000-679X	<b>12679</b>	<b>14679</b>
095000-691X	<b>12691</b>	<b>14691</b>
095000-697X	<b>12697</b>	<b>14697</b>
095000-698X	<b>12698</b>	<b>14698</b>

\* Double control valves



## CONTROL VALVES AND PLUNGERS



Injector No.	Control Valve Seven Code	Plunger Seven Code
095000-699X	<b>12699</b>	<b>14699</b>
095000-703X	<b>12703</b>	<b>14703</b>
095000-706X	<b>12706</b>	<b>14706</b>
095000-728X	<b>12728</b>	<b>14728</b>
095000-733X	<b>12733</b>	<b>14733</b>
095000-739X	<b>12739</b>	<b>14739</b>
095000-741X	<b>12741</b>	<b>14741</b>
095000-753X	<b>12753</b>	<b>14753</b>
095000-754X	<b>12754</b>	<b>14754</b>
095000-763X	<b>12763</b>	<b>14763</b>
095000-764X	<b>12764</b>	<b>14764</b>
095000-766X	<b>12766</b>	<b>14766</b>
095000-768X	<b>12768</b>	<b>14768</b>
095000-769X	<b>12769</b>	<b>14769</b>
095000-771X	<b>12771</b>	<b>14771</b>
095000-772X	<b>12772</b>	<b>14772</b>
095000-773X	<b>12773</b>	-

Injector No.	Control Valve Seven Code	Plunger Seven Code
095000-775X	<b>12775</b>	<b>14775</b>
095000-776X	<b>12776</b>	<b>14776</b>
095000-778X	<b>12778</b>	<b>14778</b>
095000-779X	<b>12779</b>	<b>14779</b>
095000-780X	<b>12780</b>	<b>14780</b>
095000-789X	<b>12789</b>	<b>14789</b>
095000-801X	<b>12801</b>	<b>14801</b>
095000-822X	<b>12822</b>	<b>14822</b>
095000-829X	<b>12829</b>	-
095000-831X	<b>12831</b>	-
095000-837X	<b>12837</b>	-
095000-890X	<b>12890</b>	<b>14890</b>
095000-956X	<b>12956</b>	<b>14956</b>
095000-977X	<b>12977</b>	-
295050-020X	<b>12G20</b>	-
295050-046X	<b>12G46</b>	-
295050-081X	<b>12G81</b>	-



## INJECTORS SPARE PARTS



**33700**  
Butterfly Shutter



**33701**  
Hemisphere 2mm



**33702**  
Injector Filter

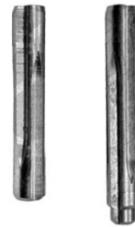

**337021** Bar Filter 27mm  
**337022** Bar Filter 30mm



**33703**  
Kit with Joint (2 ways) +  
Washer + Clip + O-rings



**33704**  
Kit with Joint (1 way) +  
Washer + Clip + O-rings



**33705**  
Nut



**33706**  
Shutter with  
hemisphere



**33707**  
Nut



**33714**  
Valve G4S  
Mazda  
295700-0210  
295700-0400



**33715**  
Valve G4S  
Toyota/Isuzu  
23670-0E010/020  
8-98399618-0



**33716**  
Valve G4S  
Toyota  
23670-0E060/070



**33717**  
Valve G4S  
Hyundai  
33800-4A900/  
4C940/4A950



**33730**  
Ø 17 – L. 33,5 – M15  
Min 25 pcs



**33731**  
Ø 19 – L. 41,5 – M17  
Min 25 pcs



**33732**  
Ø 19 – L. 42 – M17  
Min 25 pcs



## INJECTORS SPARE PARTS



**33733**  
 Ø 19 – L. 42 – M17  
 Min 25 pcs



**33734**  
 Ø 19 – L. 42,5 – M17  
 Min 25 pcs



**33735**  
 Ø 19 – L. 43 – M17  
 Min 25 pcs



**33736**  
 Ø 21 – L. 43,3 – M19  
 Min 25 pcs



**33737**  
 Ø 21,3 – L. 46,8 – M19  
 Min 25 pcs



**33738**  
 Ø 21,2 – L. 47,75 – M18  
 Min 25 pcs



## PUMPS SPARE PARTS

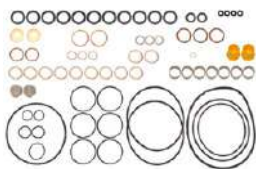

**33290**  
 094040-0010  
 for HP0 pump  
 (Mitsubishi)



**33295**  
 094040-0030  
 for HP0 pump  
 (John Deere series 20)



**33601**  
 097490-0010  
 for HP2 pump  
 (Toyota)



**33650**  
 294009-0030/31  
 for HP3 pump  
 (Nissan)



## PUMPS SPARE PARTS



**33651**  
294009-0032  
for HP3 pump



**33660**  
294009-0050/52  
for HP4 pump  
(John Deere series 30)



**33663**  
294009-0080  
for HP3 pump  
(Mitsubishi and  
Toyota)



**33665**  
294009-0110  
for HP3 pump  
(Citroen, FIAT, Ford,  
Opel and Peugeot)



**33667**  
For HP5 pump  
Pump ref. 2360020-  
AAA = 31405129 (Volvo)



**SCV0120**  
096710-0120 (RED)  
for HP2 pump



**SCV0130**  
096710-0130 (GREEN)  
for HP2 pump



**SCV0040**  
294200-0040  
for HP3 pump



**SCV0190**  
294200-0190  
for HP4 pump



**SCV0300**  
294200-0300  
for HP3 pump



**SCV0360**  
294200-0360  
for HP3 pump



**SCV0370**  
294200-0370  
for HP3 pump

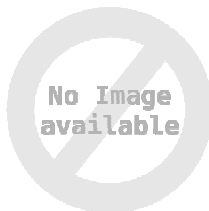

**SCV0380**  
294200-0380  
for HP4 pump

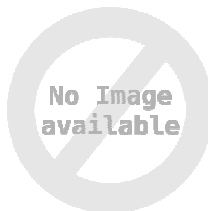

**SCV0460**  
294200-0460  
for HP3 pump



**SCV0650**  
294200-0650  
for HP3 pump



**SCV0660**  
294200-0660  
for HP3 pump



## PUMPS SPARE PARTS



SCV APPLICATION CHART		
<b>SCV0120</b> <b>SCV0130</b>	097300-0018 / 0041 / 0071 / 0090	
<b>SCV0040</b>	294000-0019 / 0065 / 0102 / 0119 / 0173 / 0356 / 0369 / 0435 / 0440 / 0544 / 0552 / 0700 / 0850 / 0890 / 0900 / 0910 / 0920 / 1040 / 1100 / 1310 / 1320 / 1510	
<b>SCV0190</b>	294050-0081 / 0091 / 0113 / 0133 / 0160 / 0194 / 0211	Hino Isuzu Mitsubishi
<b>SCV0300</b>	294000-0306 / 0316 / 0356 / 0369 / 0380 / 0435 / 0440 / 0544 / 0840 / 0860 / 0870 / 1040	Toyota
<b>SCV0360</b>	294000-0237 / 0334 / 0342 / 0404 / 0412 / 0424 / 0503 / 0532 / 0562 / 0581 / 0621 / 0640 / 0654 / 0662 / 0690 / 0751 / 0763 / 0770 / 0782 / 0952 / 1010 / 1240 / 1250	
<b>SCV0370</b>	294000-0460 / 0462 / 0490 / 0493 / 0570 / 0571 / 0573 / 0610 / 0612 / 0680 / 0681 / 1290	
<b>SCV0380</b>	294050-0060	John Deere
<b>SCV0460</b>	294000-0621	Mazda
<b>SCV0650</b>	294000-0030 / 0038 / 0039 / 0186 / 0196 / 0200 / 0205 / 0206 / 0294 / 0612 / 0673 / 0732 / 0822 / 0832 / 1150 / 1330 / 1390 / 1430	
<b>SCV0670</b>	294050-0036 / 0042 / 0071 / 0091 / 0105 / 0133 / 0160 / 0194 / 0203 / 0211 / 0223 / 0291 / 0430 / 0460 / 0500 / 0520	Mitsubishi
<b>SCV2750</b>	294000-1130 / 1140 / 1190 / 1200	Isuzu Mitsubishi
<b>SCV2760</b>	294000-1122 / 1180 / 1210 / 1220 / 1360 / 1370 / 1400	
<b>SCV2960</b>	294000-1700	Mitsubishi
<b>SCV3640</b>	294000-0594	Hino Toyota
<b>SCV9972</b>	294050-0420	Isuzu



## CALIBRATION SHIMS

**15121**  
Shim Kit  $\varnothing$  23,2 –  
Hole  $\varnothing$  20  
Total items 120 pcs. –  
12 shims size from  
2,99 to 3,10 (cut 0,01)

**15123**  
Shim Kit  $\varnothing$  24,3 –  
Hole  $\varnothing$  21,5  
Total items 120 pcs. –  
12 shims size from  
1,50 to 1,72 (cut 0,02)

**15124**  
Shim Kit  $\varnothing$  24,3 –  
Hole  $\varnothing$  21,5  
Total items 230 pcs. –  
24 shims size from  
1,50 to 1,72 (cut 0,01)



## TOOLS

**10100**  
Injector Disassembly  
Spanner for 3 pin ring  
nut for Denso CR

**10101**  
Wrench set to  
unlock/lock the 3 pin  
ring nut  
for Denso CR

**10102**  
Universal adapter for  
fixing Denso CR  
injectors

**10103**  
Wrench to  
unlock/lock nozzle  
nut. Hexagonal int 14  
mm / ext 27 mm

**10104**  
Wrench to  
unlock/lock coil nut.  
Size: 27mm - 6 Points

**PRODUCT UPDATE – March 2009 (last update 19.03.2026)**

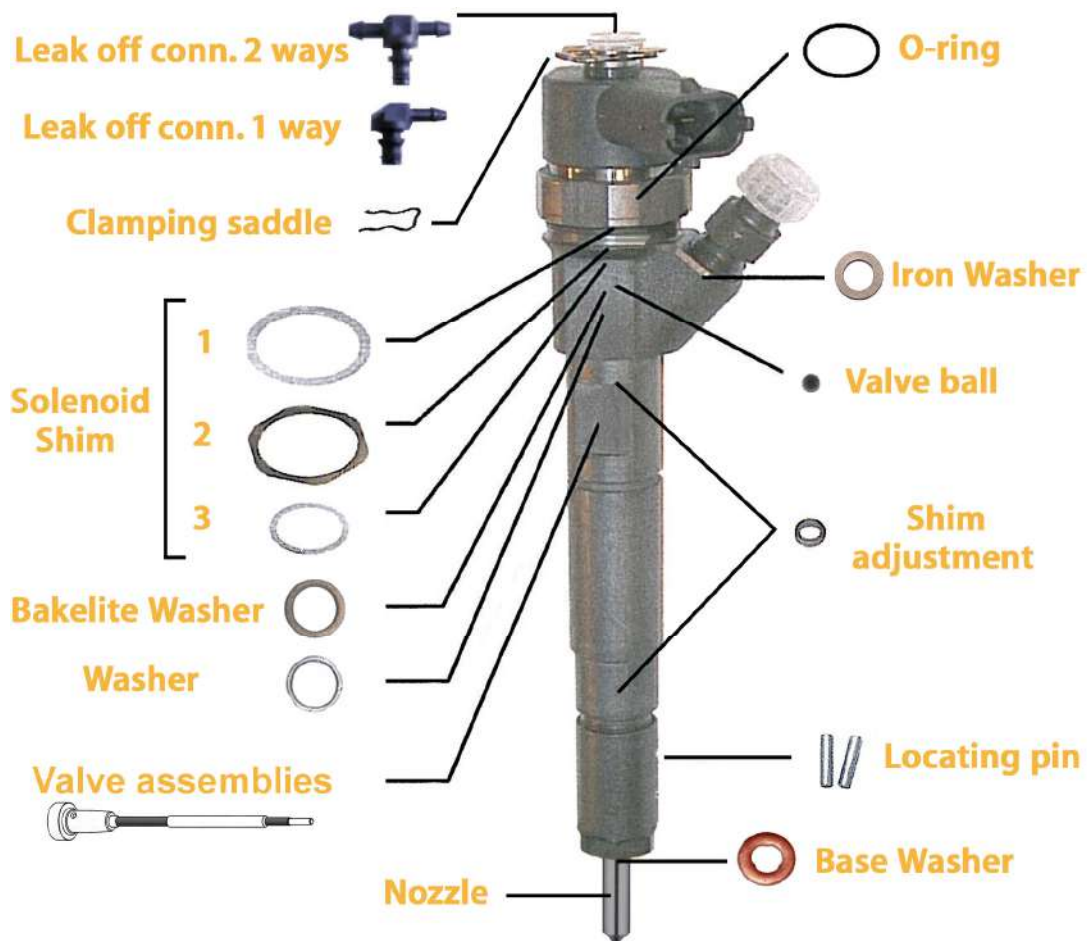

## Nozzles and spare parts for BOSCH® COMMON RAIL INJECTORS AND PUMPS for traditional and multijet systems

We actually have in our line **more than 100 nozzles** suitable for **Bosch® Common Rail systems** and we are now ready to offer also a wide range of spare parts for repairing injectors. **Common Rail is the present and the future** and will also break through in the emerging markets in Asia as a result of increasingly strict emissions standards. Modern Common Rail diesel engines use up to 30 per cent less fuel while emitting up to 25 per cent less carbon dioxide (CO<sub>2</sub>).

Check out in next pages our Common Rail products.



## NOZZLES

Seven Code	Stamping	Part Number	Injector No.	Main Applications
718962	DLLA155P 822	0433 171 562	0445 120 003 0445 120 004	Renault Premium
718970	DLLA156P 889/	0433 171 594	0445 110 034 0445 110 035	Mercedes E320, S320, Sprinter, Vito, V200 and V220
718974	DLLA145P 926			See 718975
718975	DLLA145P 926+	0433 171 616	0445 110 047 0445 110 266	BMW 330, 530, 730 and X5 and Range Rover III
7190038	DLLA150P1011/	0433 171 654	0445 110 064 0445 110 101 0445 110 731 0445 110 764	Hyundai Accent, Elantra, Matrix, Santa Fe and Trajet KIA Carens II and XTREK
7190069	DLLA144P 1050	0433 171 681	0445 120 012 0445 120 013	Renault Midlum and Premium
719007	DLLA140P 1051	0433 171 682	0445 120 016 0445 120 017	Renault Midlum
7190098	DLLA160P 1063+	0433 171 690	0445 110 080 0445 110 122 0445 110 131	BMW 320, 330, 530, 730 and X5
719010	DLLA148P 1067	0433 171 693	0445 110 081 0445 110 231 0445 110 336 0445 110 337	Agrale-Deutz Furgovan and Marrua, Chevrolet Blazer and S10, Marco Polo Volare V5 and V6, Nissan Frontier and XTerra, Volkswagen LT 28, 35, 46
7190102	DLLA143P 1069	0433 171 695	0445 110 084	Renault Avantime, Espace IV, Laguna II and Vel Satis
719011	DLLA150P 1076	0433 171 699	0445 120 019 0445 120 020 0445 120 084	Renault Kerax and Premium
7190141	DLLA156P 1107+	0433 171 712	0445 110 095 0445 110 096 0445 110 120 0445 110 121 0445 110 201 0445 110 202	Mercedes E320, S320, C200, C220, C270, CLK270, E200, E220 and E270 CDI, Sprinter, V200, V220 and Vito
719016	DLLA156P 1114	0433 171 719	0445 110 091 0445 110 092 0445 110 306	Hyundai H-1 and Starex CRDi KIA Sorento CRDi
719021	DLLA150P 1197/	0433 171 755	0445 110 126 0445 110 290 0445 110 729	Hyundai Santa Fe CRDi-VGT
719024	DLLA148P 1221	0433 171 771	0445 110 111	Alfa Romeo 147, 156, 166 and GT JTD, FIAT Stilo JTD and Lancia Thesis JTD



## NOZZLES

Seven Code	Stamping	Part Number	Injector No.	Main Applications
7190244	DLLA150P 1224	0433 171 774	0445 110 083	FIAT Albea, Doblò, Idea, Palio, Panda and Punto, Lancia Musa and Ypsilon, Opel Agila, Combo, Corsa, Meriva and Tigra, Suzuki Ignis, Swift and Wagon R+
719026	DLLA153P 1246++	0433 171 788	0445 110 137 0445 110 138 0445 110 162 0445 110 163 0445 110 191 0445 110 192	Mercedes Sprinter 316, 416 CDI, Vito and Viano CDI
7190291	DLLA153P 1270	0433 171 800	0445 110 155 0445 110 156 0445 110 176 0445 110 177 0445 110 193 0445 110 194	Mercedes C200, C220, CLC, CLK, E200, E220, E270, E320 and S320
719035	DLLA160P 1308	0433 171 817	0445 110 161 0445 110 216	BMW 120, 320, 330, 520, 530, X3 and X5
7190353	DLLA148P 1312	0433 171 819	0445 110 168 0445 110 880	Nissan and Renault Mascott and Master II
719036	DLLA148P 1334	0433 171 828	0445 110 175	Opel Astra 1.7 CDTi
719038	DLLA146P 1339++	0433 171 831	0445 120 030 0445 120 218	MAN Lion's Coach, TGA and TGS
7190386	DLLA148P 1347	0433 171 838	0445 110 159 0445 110 243 0445 110 391	Alfa Romeo 147, 156 and GT FIAT Bravo, Croma and Stilo Opel Astra, Signum, Vectra, Zafira and SAAB 9-3 and 9-5
7190394	DLLA142P 1363	0433 171 846	0445 110 187	FIAT Doblò and Idea and Lancia Musa
7190399	DLLA156P 1367	0433 171 847	0445 110 185 0445 110 283 0445 110 762	Hyundai Porter II
71904	DLLA156P 1368	0433 171 848	0445 110 186 0445 110 279 0445 110 730 0445 110 763	Hyundai H-1, Libero and Starex and KIA Sorento
719041	DLLA156P 1368/			See 71904
719042 •	DLLA150P 1373	0433 171 853	0445 110 188	Citroen C4, C5 and Xsara Picasso, Ford Focus and Fusion, Mazda 3 Peugeot 206, 307 and 407 Volvo C30, S40 and V50



## NOZZLES

Seven Code	Stamping	Part Number	Injector No.	Main Applications
719043	DLLA140P 1377/	0433 171 855	0445 120 036	IVECO Daily
719044	DLLA158P 1385	0433 171 860	0445 120 027	Chevrolet Silverado 3500 and GMC Sierra 2500
71905	DLLA143P 1404	0433 171 870	0445 120 043	Agrale 8500, 9200, W8, W9, MA and Volkswagen Worker
719050	DLLA146P 1405/	0433 171 871	0445 120 040	Daewoo
719051	DLLA144P 1417	0433 171 878	0445 120 044	MAN TGA
7190511	DLLA154P 1418	0433 171 879	0445 120 045	MAN Lion's City, NL243F, NL283F, TGA, TGL, TGM
7190513 ••	DLLA157P 1424	0433 171 886	0445 120 048	Fuso
7190514 ••	DLLA157P 1425	0433 171 887	0445 120 049	Fuso Canter 4.9L
7190550	DLLA149P 1471/	0433 171 914	0445 110 239 0445 110 311	Citroen Berlino, C3, C4, Jumpy and Xsara, FIAT Scudo, Ford Fiesta, Focus, Fusion and C-MAX, Mazda 2 and 3, Peugeot 207, 307, Expert and Partner and Suzuki SX4
7190551	DLLA155P 1493	0433 171 921	0445 110 250	Mazda BT50 2.5L
719055124	DLLA155P 1514	0433 171 935	0445 110 249	Mazda BT50 3.0L
719055125	DLLA149P 1515/	0433 171 936	0445 110 259 0445 110 281 0445 110 297	Citroen C3, C4, C5 and XSara, Ford C-Max and Focus, Mazda 3, MINI One D and Cooper D, Peugeot 206, 207, 307, 308 and 407 and Volvo C30, S80 and V70
719055127	DLLA148P 1524++	0433 171 939	0445 120 061 0445 120 128 0445 120 217 0445 120 274	MAN TGA, TGS, TGX, SU, NL, NG, Lion's City, Lion's Regio and Lion's Coach
719055129	DLLA143P 1532	0433 171 944	0445 110 252	Citroen C2, C3 and NEMO Peugeot 206, 207 and Bipper
71905516	DLLA143P 1536	0433 171 947	0445 120 054	Case 580, 590 and 695, Irisbus Proway, Iveco 170, 240, 260, EuroCargo, EuroMidi, Vertis and New Holland B100, B110 and B115
71905519	DLLA144P 1539	0433 171 949	0445 120 070 0445 120 241	Cummins 8.9L for Jinlong and Dongfeng buses and Kamaz 6520
71905521 ••	DLLA146P 1545	0433 171 953	0445 120 050 0445 120 185	RAM 3500 6.7L Pickup



## NOZZLES

Seven Code	Stamping	Part Number	Injector No.	Main Applications
719055211 ••	DLLA152P 1546	0433 171 954	0445 120 072	Mitsubishi Canter 3L and 4.9L
719055227 ••	DLLA149P 1562	0433 171 961	0445 120 063 0445 120 340	Cummins IPL26/Ziris 20S
719055229 ••	DLLA150P 1564	0433 171 963	0445 120 064 0445 120 136 0445 120 137	Deutz, Renault Midlum, Premium and Volvo FE
71905523	DLLA144P 1565	0433 171 964	0445 120 066	KHD engine for Volvo excavator
71905524 ••	DLLA150P 1566	0433 171 965	0445 120 074 0445 120 138 0445 120 139	Renault Midlum II, Premium II and Volvo B7R Urbano
71905525 •	DLLA137P 1577	0433 171 966	0445 120 075 0445 120 638	Case 4.5L and 6.7L, Case IH Puma, Maxxum, Patriot and New Holland
71905526	DLLA146P 1581	0433 171 968	0445 120 067	KHD engine for Volvo excavator
71905528	DLLA142P 1595	0433 171 974	0445 110 273 0445 110 435	Citroen Jumper, FIAT Ducato, Iveco Daily, Peugeot Boxer and UAZ Patriot
71905534 •	DLLA153P 1608	0433 171 982	0445 110 274 0445 110 275 0445 110 724	Dodge H100, Hyundai H-1 2.5 CRDi and Starex and KIA Sorento
71905535	DLLA146P 1610	0433 171 984	0445 120 080	
71905539	DLLA143P 1619	0433 171 988	0445 120 089	MWM Diesel, Volvo VM, Volkswagen Constellation
7190554	DLLA150P 1622	0433 171 991		FAW J6 and Golden Dragon GDR1
7190556	DLLA145P 1647	0433 172 010		VM Motori
7190558	DLLA142P 1654	0433 172 015		WDEW Weichai Power Co. FOTON Auman 9.7D and Shanqi Delong 9.7D
7190559	DLLA145P 1655	0433 172 016		Weichai, CNHTC, Shanqi, JAC, FOTON
719056	DLLA151P 1656	0433 172 017		FAW
7190562 ••	DLLA148P 1660	0433 172 019	0445 110 299 0445 110 308 0445 110 327	Alfa Romeo 159, Brera, Giulietta, Spider, Chevrolet Malibu, FIAT Bravo, Doblò, Sedici, Lancia Delta, Opel Astra, Combo, Cascada, Insigna, Zafira, SAAB 9-3
7190563 ••	DLLA152P 1661+	0433 172 020	0445 110 300	Alfa Romeo MiTo, FIAT Bravo, Doblò, Grande Punto, Idea, Linea and Punto Evo, Lancia Delta and Musa, Opel Combo
7190566	DLLA150P 1666	0433 172 022		Great Wall



## NOZZLES

Seven Code	Stamping	Part Number	Injector No.	Main Applications
7190568	DLLA82P 1668	0433 172 024		JMC
719057	DLLA155P 1674	0433 172 026		BAW Fenix 3.2 FAW LD Truck 3TCK
7190575 ●●	DLLA152P 1681	0433 172 029	0445 110 310	Mahindra Maxximo and Scorpio
7190578	DLLA145P 1686	0433 172 033		Weichai WP6 (or Deutz 226B)
719058	DLLA148P 1688	0433 172 034		Yuchai
7190582	DLLA152P 1690	0433 172 036		King Long
7190583	DLLA118P 1691	0433 172 037		Ford Cargo and Volkswagen Constellation
71905836	DLLA143P 1696	0433 172 039		Weichai WEC2 11.6L Eu3
71905837	DLLA118P 1697	0433 171 984	0445 120 125	Cummins
71905838 ●●	DLLA147P 1702	0433 172 044	0445 110 313 0445 110 445 0445 110 446	Changfeng and Foton
7190586 ●	DLLA144P 1707	0433 172 045	0445 120 122	Dongfeng DFL/DFZ ISLe375 8.9L
7190584	DLLA142P 1709	0433 172 047	0445 120 121	Dongfeng Prima 3138 K 8.9L
71905849 ●●	DLLA139P 1711	0433 172 048	0445 110 298	Volvo C70, S80, V70, XC60, XC70
7190585	DLLA150P 1712	0433 172 049	0445 120 117	FAW J6 12.4L
71905852 ●●	DLLA145P 1714	0433 172 051	0445 120 133	Cummins
7190587	DLLA145P 1720	0433 172 055		
7190588	DLLA153P 1721	0433 172 056		Dongfeng
719059	DLLA146P 1724	0433 172 058		Weichai
7190591	DLLA146P 1725	0433 172 059		Weichai
7190592 ●●	DLLA148P 1726	0433 172 060	0445 120 105	MAN D0836
7190595	DLLA150P 1734	0433 172 061	0445 110 322	Lancia Ypsilon
7190596 ●●	DLLA145P 1738	0445 110 321	0433 172 062	Land Wind 2.5D
7190597	DLLA147P 1740	0433 172 064	0445 120 143 0445 120 180	Case IH
7190598 ●●	DLLA150P 1744	0433 172 067	0445 110 326 0445 110 425 0445 110 450	Chevrolet Aveo, Beat, Enjoy, Sail, Opel Astra, Corsa and Meriva
719060	DLLA152P 1768	0433 172 078		Weichai
7190611	DLLA150P 1781	0433 172 088		Weichai



## NOZZLES

Seven Code	Stamping	Part Number	Injector No.	Main Applications
7190613 ••	DLLA149P 1787	0433 172 091	0445 120 142	YAMZ
7190614 ••	DLLA145P 1794	0433 172 093	0445 120 157	IVECO Crossway, Magelys, Stralis, Trakker and Urbanway, New Holland CR, FR, T8 and T9, Case 1021, 1121, AF6130, AF7130 and AF7230
7190615	DLLA154P 1795	0433 172 094	0445 120 147	MAN Lion's City, NL, NM, SU, TGL and TGM
7190629 ••	DLLA147P 1814	0433 172 107	0445 120 153	Kamaz 5460, 5480 and 62115 all 11.8L
719063	DLLA148P 1815	0433 172 108	0445 120 156 0445 120 290	Yuchai YCL_EU3 8.4L
7190634	DLLA152P 1819	0433 172 111	0445 120 170 0445 120 224	Weichai
7190637	DLLA150P 1827	0433 172 115	0445 120 164 0445 120 293	Yuchai 6JA Eu3
7190638	DLLA150P 1828	0433 172 116	0445 120 163 0445 120 226	Yuchai 6G Eu3
71906387	DLLA153P 1831	0433 172 119	0445 120 186 0445 120 308	MAN TGL and TGM and Volkswagen Constellation
7190639	DLLA152P 1832	0433 172 120	0445 120 162 0445 120 307	MAN NM, Lion's City, Lion's Intercity, TGL and TGM and Volkswagen 15, 17, Constellation and Worker
7190641 ••	DLLA150P 2118	0433 172 118	0445 110 338	Opel Vivaro, Renault Trafic II
7190643 •	DLLA150P 2123	0433 172 123	0445 120 291 0445 120 438	Yuchai XCM4 QY8B.5 4.3L
71906435 ••	DLLA151P 2128	0433 172 128	0445 110 362 0445 110 363	JMC Lightruck 2.8L
71906436 ••	DLLA148P 2129	0433 172 129	0445 110 364 0445 110 365	Dongfeng DFL110 Pickup 2.8L
7090644	DLLA145P 2135	0433 172 135	0445 110 354	Chevrolet S10 2.8L and Trailblazer 2.8L
71906441 ••	DLLA155P 2136	0433 172 136	0445 110 339	Citroen C3, DS3, Ford Fiesta, Peugeot 2008, 206+, 207, 207+, 208
71906442 ••	DLLA152P 2137	0433 172 137	0445 110 340 0445 110 379	Citroen Berlingo, C-Elysee, C3, C4, DS3 and Jumpy, Ford Fiesta, FIAT Scudo, Peugeot 2008, 207, 208, 301, 308, Expert and Partner
71906448 ••	DLLA150P 2143	0433 172 143	0445 120 191 0445 120 260	Weichai



## NOZZLES

Seven Code	Stamping	Part Number	Injector No.	Main Applications
71906449 ••	DLLA145P 2144	0433 172 144	0445 120 187 0445 120 336 0445 120 366 0445 120 414 0445 120 417	Cummins Engine QSB 6.7L
7190645 •	DLLA146P 2145	0433 172 145	0445 120 050 0445 120 185 0445 120 193	Dodge RAM 3500 6.7L
71906456 •	DLLA141P 2146	0433 172 146	0445 120 134	Cummins CUM142, Foton Aumark 3.8L and GAZ Valday
71906457 ••	DLLA150P 2147	0433 172 147	0445 110 375 0445 110 634	Opel Movano 2.3L and Vivaro 2.0L and Renault Master 2.3L
719064573	DLLA145P 2150	0433 172 150	0445 120 177	Cummins 4.5L, 5.9L and 6.7L
71906458 ••	DLLA150P 2153	0433 172 153	0445 120 178	YMZ 4.4L and 6.7L
71906459 ••	DLLA150P 2154	0433 172 154	0445 120 192	Foton Aolin 4.0L
7190646	DLLA143P 2155	0433 172 155	0445 120 071 0445 120 161 0445 120 184 0445 120 204	Cummins 4.5L and 5.9L, Ford Cargo C 4.5L, Dodge RAM 3500 6.7L and 4500 6.7L and Tata Prima 4928S 6.7L
7090647 ••	DLLA148P 2158	0433 172 158	0445 120 202	MAN Lion's Coach, TGS and TGX
7190648 •	DLLA162P 2160+	0433 172 160	0445 110 368 0445 110 369 0445 110 429 0445 110 646	Audi A1, A3, A4, A5, A6, Q3, Q5 and TT, Seat Alhambra, Altea, Exeo, Ibiza and Leon, Skoda Octavia, Super and Yeti, Volkswagen Amarok, Beetle, CC, Caddy, Crafter, EOS, Golf VI, Jetta, Passat, Scirocco, Sharan, Tiguan and Touran
7190649 •	DLLA146P 2161	0433 172 161	0445 120 199	Cummins
719065 •	DLLA149P 2166	0433 172 166	0445 120 215 0445 120 394	FAW J6 11L
7190652 •	DLLA145P 2168	0433 172 168	0445 110 376 0445 110 594	Agrale Marrua 2.8L, Ford F350 2.8L and F4000 2.8L, Marco Polo Cinco 2.8L, GAZ GAZelle and Sobol, JAC T140
71906525 ••	DLLA160P 2176	0433 172 176	0445 110 382 0445 110 478 0445 110 595 0445 110 616 0445 110 617	BMW 120, 320, 330, 420, 430, 518, 520, 530, 730, X1, X3, X4, X5 and X6
71906531 ••	DLLA151P 2182	0433 172 182	0445 120 227 0445 120 228	Weichai



## NOZZLES

Seven Code	Stamping	Part Number	Injector No.	Main Applications
7190654	DLLA120P 2185	0433 172 185		
71906543 ••	DLLA153P 2189	0433 172 189	0445 120 232 0445 120 309	Dongfeng
71906546 ••	DLLA150P 2197	0433 172 197	0445 120 247 0445 120 395	FAW
7190655	DLLA128P 2201	0433 172 201	0445 120 237	Case MX 335 with Cummins engine
7190656 •	DLLA118P 2203	0433 172 203	0445 120 236	Cummins 6.7L
7190657 ••	DLLA153P 2210	0433 172 210	0445 120 261	Weichai
7190658 •	DLLA146P 2213	0433 172 213	0445 120 257	Ford Cargo C and Volkswagen Constellation
7190659 ••	DLLA152P 2217	0433 172 217	0445 120 262 0445 120 396	FAW
71906592 ••	DLLA150P 2219	0433 172 219	0445 120 263	FAW
719066 •	DLLA148P 2221	0433 172 221	0445 120 265	Weichai WP12 Eu4
7190660 ••	DLLA148P 2222	0433 172 222	0445 120 266	Weichai
7190661 •	DLLA139P 2229	0433 172 229	0445 110 418 0445 110 520	Citroen Jumper, FIAT Ducato, Iveco Daily and Peugeot Boxer
71906613 ••	DLLA145P 2236	0433 172 236	0445 124 015 0445 124 036	Astra HD9 12.9L
71906614 ••	DLLA149P 2239	0433 172 239	0445 110 420	Chery
71906615 ••	DLLA151P 2240	0433 172 240	0445 120 277 0445 120 397	FAW J6 11L D
71906617 ••	DLLA138P 2246	0433 172 246	0445 110 421 0445 110 422	Iveco
71906619 ••	DLLA148P 2254	0433 172 254	0445 110 430	Jeep Grand Cherokee 3.0L
7190662 •	DLLA150P 2259	0433 172 259	0445 120 225 0445 120 439	Yuchai V7 5.2L
7190663 •	DLLA142P 2262	0433 172 262	0445 120 289	Cummins ISDe
7190664	DLLA145P 2270	0433 172 270	0445 120 297 0445 120 416	Agrale Deutz, Daewoo Lestar, Mercedes LO815, Sunlong Bus SLK6875, Foton Aumark, JAC HFC and Yuejin NJ1317-NJ914
7190665 •	DLLA144P 2273	0433 172 273	0445 120 304	Cummins ISLe Eu3



## NOZZLES

Seven Code	Stamping	Part Number	Injector No.	Main Applications
71906655 ●●	DLLA140P 2281	0433 172 281	0445 110 465 0445 110 466	
71906666	DLLA163P 2291+			Audi, Seat, Skoda and Volkswagen
71906668 ●●	DLLA154P 2302	0433 172 302	0445 110 485	Dacia Dokker, Duster, Lodgy, Logan and Sandero, Nissan Evalia, Kubistar, Micra, NP200, NV200 and Note, Renault Captur, Clio IV and Symbol
71906684 ●●	DLLA155P 2307	0433 172 307	0445 110 489	Ford B-Max, C-Max, Fiesta, Focus, Ka+, Kuga, Mondeo, Tourneo, Transit, Grand C-Max
71906669 ●●	DLLA150P 2339	0433 172 339	0445 110 511	Iveco
71906692 ●●	DLLA152P 2344	0433 172 344	0445 120 343	Weichai
71906693 ●●	DLLA138P 2355	0433 172 355		
71906694 ●●	DLLA148P 2369	0433 172 369	0445 120 321	Sinotruck
71906695 ●●	DLLA146P 2370	0433 172 370	0445 120 342	Dodge and RAM
719066955 ●●	DLLA160P 2380	0433 172 380	0445 110 546	Nissan NV300, Qashqai, Xtrail, Renault Espace V, Kadjar, Koleos, Megane IV, Scenic III + IV, Grand Scenic III + IV, Talisman, Trafic III
71906696 ●●	DLLA150P 2386	0433 172 386	0445 120 357	Sinotruck
71906698 ●●	DLLA145P 2397	0433 172 397	0445 120 361	Iveco
719066981 ●●	DLLA160P 2398	0433 172 398	0445 110 569	FIAT Talento, Opel Vivaro, Renault Espace, Grand Scenic, Megane, Scenic, Talisman and Trafic
719066985 ●●	DLLA155P 2400+	0433 172 400	0445 110 573 0445 110 574	Mercedes Benz 114, 116 and 119 CDI, V200, V220 and V250
719066986	DLLA156P 2401	0433 172 401	0445 110 565 0445 110 566	Citroen Berlingo, C3, C4, C-Elysee, DS3, DS4, DS5, Jumpy and SpaceTourer
719066987 ●●	DLLA150P 2432	0433 172 432	0445 110 614	Alfa Romeo MiTo, Citroen Nemo, FIAT 500, Fiorino, Panda, Qubo, Lancia Ypsilon, Opel Combo and Peugeot Bipper



## NOZZLES

Seven Code	Stamping	Part Number	Injector No.	Main Applications
7190699 ••	DLLA150P 2440	0433 172 440	0445 110 628 0445 110 629	JMC
7190670 ••	DLLA156P 2457	0433 172 457	0445 110 653 0445 110 654	Jaguar, Land Rover Discovery and Range Rover Evoque
7190671 ••	DLLA156P 2458	0433 172 458	0445 110 652	Dacia Dokker, Duster, Lodgy, Logan and Sandero
7190674 ••	DLLA147P 2474	0433 172 474	0445 120 391	CNHTC Howo Foton, JAC J4 and SEI 2, Foton AUV Bus, Auman, Aumark, Forland and Ollin
71908 ••	DLLA150P 2641		0445 110 937 0445 110 938	FIAT 500L, 500X, Doblò, Fiorino, Qubo and Tipo
719832	DSLA156P 736	0433 175 163		Mercedes C200, C220, C270, CLK270, E200, E220, E270, V200, V220, Sprinter and Vito CDI
719833	DSLA156P 737	0433 175 164		Mercedes A160 and A170
719835	DSLA145P 763	0433 175 175		Alfa Romeo 145, 146, 156, and 166 JTD FIAT Brava, Bravo, Marea, Marengo and Multipla JTD Lancia Kappa and Lybra JTD
719836	DSLA145P 763+			See 719835
719852	DSLA142P 795	0433 175 196		Chevrolet Tracker Citroen Berlingo, Evasion, Jumpy, Xantia and Xsara HDi FIAT Scudo and Ulysse JTD Lancia Zeta JTD Peugeot 206, 306, 406, 806, Expert and Partner HDI Suzuki Grand Vitara Tdi
7198544	DSLA136P 804	0433 175 203		Citroen Jumper HDi, FIAT Ducato JTD, Iveco Cityclass, Daily and Scudato, Peugeot Boxer HDI, Renault Mascott 110, 130, 140 and 150
719855	DSLA136P 804/	0433 175 203		See 7198544
719866	DSLA140P 862+	0433 175 230		Nissan Primastar dCi Opel Movano and Vivaro CDTI/DTI, Renault Laguna I & II, Megane, Scenic, Traffic and Espace IV
719868	DSLA145P 864+	0433 175 232	0445 110 029	BMW 530d and 730d



## NOZZLES

Seven Code	Stamping	Part Number	Injector No.	Main Applications
719875	DSLA143P 970	0433 175 271	0445 120 007	Agrale-Deutz MA and MT Electronic, Dongfeng King Long Ford Cargo C Electronic and F250, Iveco 65, 75, 80, 90, 100, 120, 130, 140, 150, 170, 180 and 320, New Holland T7060, Paz Pavlovo 3237 Volkswagen Constellation
719876	DSLA144P 971+	0433 175 272	0445 110 057	Citroen C8, Evasion and Jumpy HDi, Peugeot 806, 807 and Expert HDi, Suzuki Grand Vitara
719878	DSLA144P 973+	0433 175 274		See 719941
719879	DSLA158P 974+	0433 175 275	0445 120 008	GMC and Isuzu
7198939	DSLA140P 1033/	0433 175 297	0445 120 011	FIAT Ducato and Daily JTD
719894	DSLA154P 1034	0433 175 298	0445 110 069 0445 110 070	Mercedes Sprinter, Vito, V200 and V220
719899	DSLA146P 1055/	0433 175 308	0445 110 075 0445 110 135	Citroen C2, C3 and Xsara Peugeot 206 and 307
71990	DSLA143P 1058	0433 175 309	0445 120 018 0445 120 113	Cummins
71991	DSLA156P 1079/+	0433 175 314	0445 110 054 0445 110 055	Mercedes E200, E220, E270 CDI
719914	DSLA145P 1091	0433 175 318	0445 110 087	Nissan Primastar and Interstar dCi, Opel Movano and Vivaro CDTI, Renault Master and Trafic DCI
719930	DSLA154P 1129/	0433 175 333		See 719956
719931	DSLA140P 1131	0433 175 334	0445 110 109 0445 110 144	Renault Kangoo, Megane and Scenic
719941	DSLA144P 1213	0433 175 363	0445 110 019	FIAT Palio Weekend, Punto and Strada JTD
719945	DSLA153P 1242++	0433 175 366	0445 110 139 0445 110 140 0445 110 263 0445 110 264 0445 110 294 0445 110 295	Mercedes Sprinter, Viano and Vito
719951	DSLA144P 1295	0433 175 386	0445 110 119	Alfa Romeo 147, 156 and 166 JTD, FIAT Doblo, Marea, Marengo, Multipla and Stilo JTD, Lancia Lybra, Thesis JTD
719954	DSLA124P 1309	0433 175 390		See 719989



## NOZZLES

Seven Code	Stamping	Part Number	Injector No.	Main Applications
719956	DSLA154P 1320	0433 175 395	0445 110 105 0445 110 106 0445 110 107 0445 110 108 0445 110 170 0445 110 171 0445 110 181 0445 110 182 0445 110 189 0445 110 190	Jeep Grand Cherokee CRD Mercedes Sprinter, V200, V220 and Vito
719980	DSLA142P 1474	0433 175 431	0445 110 062 0445 110 076 0445 110 240	Citroen C4, C5, Berlingo, Jumper, Jumpy and Xsara, FIAT Scudo and Ducato, Peugeot 206, 306, 307, 406, 607, Boxer, Expert, Partner
719982	DSLA128P 1510	0433 175 449		See 719996
719989	DSLA124P 1659	0433 175 470	0445 120 032 0445 120 103 0445 120 114	Cummins and Dodge
719993	DSLA140P 1723	0433 175 481	0445 120 123	Dongfeng Cummins Engine Company DCEC, Kamaz, KAVZ 4235 and 4238, Paz Pavlolo, Tata Marcopolo and Prima
7199948 ●●	DSLA143P 5499	0433 175 499	0445 120 210	Cummins
7199949 ●●	DSLA124P 5500	0433 175 500	0445 120 208	Cummins
719995	DSLA143P 5501	0433 175 501	0445 120 212	Ford Cargo C and F250, New Holland TS 4.5L and 6.7L, Volkswagen 8.150, 9.150, Worker and Constellation
719996	DSLA128P 5510	0433 175 510	0445 120 059 0445 120 231	Cummins 4.5L, 5.9L and 6.7L and Komatsu
719997	DSLA124P 5516	0433 175 516	0445 120 238	Dodge 5.9L
7199971 ●●	DSLA143P 5517	0433 175 517	0445 120 060 0445 120 250	DAF CF and LF and Dongfeng ISDE6
719998	DSLA143P 5519	0433 175 519	0445 120 018 0445 120 113 0445 120 210 0445 120 255	RAM 2500 and 3500



## INJECTORS SPARE PARTS

Common Rail Injector Parts Set	Seven Code	Description
	17000	with Bakelite Washer + Washer + O-ring + Iron washer + Valve ball (F00VC05001)
	17002	with Bakelite Washer + Washer + O-ring + Iron washer + Valve ball (F00VC05006)
	17004	with Bakelite Washer + Washer + O-ring + Iron washer + Valve ball (F00VC05008)

Valve Ball	Seven Code	Description
	17010	Steel - ø 1,34 mm - 50 pcs. Suitable for F00VC05001
	17011	Ceramic - ø 1,34 mm - 50 pcs. Suitable for F00VC05002
	17012	Ceramic - ø 1,50 mm - 50 pcs. Suitable for F00VC05006
	17014	Ceramic - ø 1,34 mm - 50 pcs. Suitable for F00VC05008
	17015	Ceramic - ø 1,50 mm - 50 pcs. Suitable for F00VC05009
	17016	Steel - ø 1,50 mm - 50 pcs. Suitable for F00VC05010



Note: F00VC05002 = F00VC05008 and F00VC05006 = F00VC05009



## INJECTORS SPARE PARTS



**17033**  
F00V C21 001  
Guide Ball



**170331**  
F00V C21 002  
Guide Ball



**17034**  
F00V C22 003  
Clamping saddle



**17035**  
Tabs cap



**17036**  
Leak off connector 1  
way



**17038**  
Leak off connector 2  
ways



**17040**  
F00V C17 503  
15 x 7 x 1,5  
(Min. 50 pcs)



**17041**  
F00V C17 504  
15 x 7 x 2  
(Min. 50 pcs)



**17042**  
F00V C17 505  
15 x 7 x 2,5  
(Min. 50 pcs)



**17043**  
F00V C17 506  
15 x 7 x 3  
(Min. 50 pcs)



**17100**  
F00V C01 200  
For 0445 110 351/  
398



**17101**  
F00V C01 201  
For 0445 110 418



**17102**  
F00V C01 202  
For 0445 110 419



**17103**  
F00V C01 502  
For 0445 110 369/  
646/647/688/689



**17104**  
F00V C01 503  
For 0445 110 616/617



**171045**  
T643  
For 0445 110 818/819



## INJECTORS SPARE PARTS

 <p><b>17105</b> F00V C01 504 For CR12-20 0445 110 522</p>	 <p><b>171055</b> F00V C01 505 For 0445 110 430</p>	 <p><b>17106</b> F00V C01 506 For 0445 110 433/ 490/491/795/857</p>	 <p><b>17107</b> F00V C01 507 For 0445 110 476</p>
 <p><b>17109</b> F00V C01 509 For 0445 110 485</p>	 <p><b>17114</b> F00V C01 514 For 0445 110 546</p>	 <p><b>17124</b> F00V C45 204 For 0445 110 520</p>	 <p><b>17125</b> F00V C45 205 For 0445 110 614/618</p>
 <p><b>17142</b> F00V C01 542 For 0445 110 737/738</p>	 <p><b>17143</b> F00V C01 543 For 0445 110 768</p>	 <p><b>17200</b> F00R J00 220 Solenoid O-ring (Min. 100 pcs)</p>	 <p><b>17205</b> F00R J00 233 Solenoid nut</p>
 <p><b>17210</b> F00R J01 637 Solenoid nut</p>	 <p><b>17211</b> F00R J01 638 Solenoid nut</p>	 <p><b>SB0395</b> F00R J00 395 Solenoid</p>	 <p><b>SB2697</b> F00R J02 697 Solenoid</p>



## INJECTORS SPARE PARTS



**SB2703**  
F00R J02 703  
Solenoid



**SB2704**  
F00R J02 704  
Solenoid



**SB3054**  
F00R J30 054  
Solenoid



**SB3057**  
F00R J30 057  
Solenoid



**SB3058**  
F00R J30 058  
Solenoid



**SB3318**  
F00R J30 318  
Solenoid



**SB3319**  
F00R J30 319  
Solenoid



## CALIBRATION SHIMS AND WASHERS

Description		Seven Code
	<b>Base washer</b>	Total pcs. 1032 - Total items 15 (2 items are the leak off connectors 17036 and 17038)
	<b>Shim adjustment</b>	Set $\varnothing$ 5,43 mm - Hole $\varnothing$ 3,40 mm - Total items 240 pcs. - 24 shims size from 1,20 to 1,70 (cut 0,02)
	<b>Solenoid shim</b>	<b>Type 1:</b> Set $\varnothing$ 23,50 mm - Hole $\varnothing$ 19,00 mm - Total items 110 pcs. - 11 shims size from 1,00 to 1,10 mm (cut 0,01)
		<b>Type 2:</b> Set $\varnothing$ 22,00 mm - Hole $\varnothing$ 19,00 mm - Total items 110 pcs. - 11 shims size from 1,00 to 1,10 mm (cut 0,01)
	<b>Type 3:</b> Set $\varnothing$ 15,70 mm - Hole $\varnothing$ 10,50 mm - Total items 110 pcs. - 11 shims size from 1,20 to 1,30 mm	
		<b>17050</b>
		<b>17060</b>
		<b>17070</b>
		<b>17071</b>
		<b>17072</b>

Applications: Mercedes Sprinter, Citroen/Peugeot Hdi, FIAT Ulysse/Marea/Isuzu/VM, Ford Focus, Renault Dci/Peugeot Hdi, BMW/FIAT/SAAB 9.3, Renault Scenic, Iveco Eurocargo Tector, BMW 3.0d, Mazda 6, Citroen/Peugeot Hdi 1.4.



## CRIN VALVE ASSEMBLIES

Seven Code	Suitable for	Injector No.
180005	F00R J00 005	0445 120 002
180218	F00R J00 218	0445 120 003/004
180339	F00R J00 339	0445 120 007/018/032/079/103
180399	F00R J00 399	0445 120 009/010/014/015/019/020/084/085
180420	F00R J00 420	0445 120 011
180995	F00R J00 995	0445 120 031
181159	F00R J01 159	0445 120 024/027/044/045/053/055/056/068/105/154
181176	F00R J01 176	0445 120 036/119
181218	F00R J01 218	0445 120 030/061/100/274
181278	F00R J01 278	0445 120 054
181428	F00R J01 428	0445 120 048/049/090
181451	F00R J01 451	0445 120 064/065/074/136/137/138/139
181479	F00R J01 479	0445 120 066/067
181657	F00R J01 657	0445 120 078/124/247/262/395/396
181683	F00R J01 683	0445 120 080
181692	F00R J01 692	0445 120 130/149/150/163/169/170/191/200/214/224/226/ 227/228
181714	F00R J01 714	0445 120 050/071/161/177/184/185/187/188/193/204/267/ 269/332/336/342/356/384
181727	F00R J01 727	0445 120 265/266
181819	F00R J01 819	0445 120 157
181865	F00R J01 865	0445 120 098/099/147/148
181895	F00R J01 895	0445 120 012/013/016/017/043/077/089
181941	F00R J01 941	0445 120 037/070/097/112/115/120/121/122/125/140/144
181945	F00R J01 945	0445 120 046/113/114
182004	F00R J02 004	0445 120 050/071/085/161/177/184/185/187/188/193/204/ 267/332/336/342/356/384
182005	F00R J02 005	0445 120 008
182035	F00R J02 035	0445 120 117/145/146/158/160/192/215/261/277/397
182044	F00R J02 044	0445 120 143



## CRIN VALVE ASSEMBLIES

Seven Code	Suitable for	Injector No.
<b>182056</b>	F00R J02 056	0445 120 106/142/232/309
<b>182073</b>	F00R J02 073	0445 120 128/131/196
<b>182130</b>	F00R J02 130	0445 120 059/060/123/132/152/208/209/211/212/250
<b>182246</b>	F00R J02 246	0445 120 073
<b>182449</b>	F00R J02 449	0445 120 162/186/307/308
<b>182266</b>	F00R J02 266	0445 120 126
<b>182410</b>	F00R J02 410	0445 120 179/180/197/201/202/220/229
<b>182454</b>	F00R J02 454	0445 120 025
<b>182466</b>	F00R J02 466	0445 120 217/218/219
<b>182806</b>	F00R J02 806	0445 120 156/164/290/291/293/304/438



## CRI VALVE ASSEMBLIES

Seven Code	Suitable for	Injector No.
191001	F00V C01 001	0445 110 003/004/010/012/015/025/035/045/046/069/071/ 073/093/094
191003	F00V C01 003	0445 110 008/020/044/062
191004	F00V C01 004	0445 110 029
191007	F00V C01 007	0445 110 022/023
191015	F00V C01 015	0445 110 059
191022	F00V C01 022	0445 110 084/087/102/141/184
191023	F00V C01 023	0445 110 081/125/231/336/337
191033	F00V C01 033	0445 110 091/092/185/186/279/283/306
191034	F00V C01 034	0445 110 109/110/127/144/145/160/178
191036	F00V C01 036	0445 110 111
191037	F00V C01 037	0445 110 112/187
191038	F00V C01 038	0445 110 083
191042	F00V C01 042	0445 110 019
191043	F00V C01 043	0445 110 047/266
191044	F00V C01 044	0445 110 064/101/126/290
191045	F00V C01 045	0445 110 095/099/100/104/106/107/120/121/151/152/ 170/171
191046	F00V C01 046	0445 110 119
191051	F00V C01 051	0445 110 181/189/199/201/205/207/208/224/225
191053	F00V C01 053	0445 110 076
191057	F00V C01 057	0445 110 031
191301	F00V C01 301	0445 110 077/078/349/350
191306	F00V C01 306	0445 110 085/142/143/153/154/214/215
191310	F00V C01 310	0445 110 122/131
191312	F00V C01 312	0445 110 134/229
191313	F00V C01 313	0445 110 118/174/175
191315	F00V C01 315	0445 110 136/188/220/239/259/271/282/285/311
191317	F00V C01 317	0445 110 150/228/230
191324	F00V C01 324	0445 110 162/163/184/193/194/294/295



## CRI VALVE ASSEMBLIES

Seven Code	Suitable for	Injector No.
<b>191328</b>	F00V C01 328	0445 110 137/138/139/140/155/156/176/177/180/191/ 192/235/263/264
<b>191329</b>	F00V C01 329	0445 110 168/169/284/315
<b>191331</b>	F00V C01 331	0445 110 216
<b>191334</b>	F00V C01 334	0445 110 183/260/309/310/316/322/331
<b>191338</b>	F00V C01 338	0445 110 247/248
<b>191341</b>	F00V C01 341	0445 110 237/238
<b>191342</b>	F00V C01 342	0445 110 252
<b>191344</b>	F00V C01 344	0445 110 244/276
<b>191346</b>	F00V C01 346	0445 110 253/254/257/258/269/270/329/330
<b>191347</b>	F00V C01 347	0445 110 255/256/319/320
<b>191349</b>	F00V C01 349	0445 110 249/250
<b>191352</b>	F00V C01 352	0445 110 274/275/277/278
<b>191354</b>	F00V C01 354	0445 110 281/297
<b>191357</b>	F00V C01 357	0445 110 289/401/600/601
<b>191358</b>	F00V C01 358	0445 110 291/358/359/366/367/386/396
<b>191359</b>	F00V C01 359	0445 110 293/305/313/332/335/343/346/355/357/364/365/ 379/380/392/395/466
<b>191360</b>	F00V C01 360	0445 110 299/300/308/327
<b>191363</b>	F00V C01 363	0445 110 304/317/348/370
<b>191365</b>	F00V C01 365	0445 110 421/422/511
<b>191366</b>	F00V C01 366	0445 110 298
<b>191367</b>	F00V C01 367	0445 110 318/361/384/385
<b>191368</b>	F00V C01 368	0445 110 321/389/390
<b>191369</b>	F00V C01 369	0445 110 326/425/450
<b>191371</b>	F00V C01 371	0445 110 333/334/360/372/383
<b>191372</b>	F00V C01 372	0445 110 340/739
<b>191376</b>	F00V C01 376	0445 110 338
<b>191383</b>	F00V C01 383	0445 110 376/594







## SHAFTS FOR CP4 PUMPS

Seven Code	Suitable for	Pump Part Number
<b>30670</b>	1466C05040	0445 010 536/539/548/549/569/571/576/577
<b>30679</b>	1466C06022	0445 010 612
<b>30680</b>	1466C06025	0445 010 506/509/510/521/524/547/557/580/581/582/617/ 623/665/688/707/711/713/715/717/807/809
<b>30681</b>	1466C06030	0445 010 507/508/520/541/542/543/546/555
<b>30683</b>	1466C06034	0445 010 611/639/646/659/669/673/685/686
<b>30685</b>	1466C06042	0445 010 512/525/545/559/618/655/680
<b>30687</b>	1466C06045	0445 010 513/514/526/529/532/533/534/535/550/551/562/ 565/566/567/568
<b>306872</b>	1466C06051	0445 010 624/642/650/658/675/676/677/682/683/692/693/801
<b>306874</b>	1466C06054	0445 010 517/528/553/561/573/574/627/666/719/783/784/ 785/794
<b>306876</b>	1466C06064	0445 010 684/690/691/696
<b>306878</b>	1466C06076	0445 010 519/554/723/725
<b>30688</b>	1466C06079	0445 010 634/638/667/678/679/808/852/853/854/855
<b>306882</b>	1466C06082	0445 010 511/522/544/556/636/637
<b>306884</b>	1466C06085	0445 010 699/740/830
<b>306886</b>	1466C06088	0445 010 635
<b>306888</b>	1466C06091	0445 010 645/672
<b>30689</b>	1466C06094	0445 010 537/538/570/583
<b>30691</b>	1466C06098	0445 010 530/704
<b>306912</b>	1466C06104	0445 010 540/721/727/755
<b>306914</b>	1466C06113	0445 010 587/588/709
<b>3069146</b>	1466C06122	0445 010 578/579/592/738/739
<b>306915</b>	1466C06125	0445 010 598
<b>3069152</b>	1466C06128	0445 010 825
<b>3069158</b>	1466C06137	0445 010 804/810
<b>306916</b>	1466C06140	0445 010 703/759/773

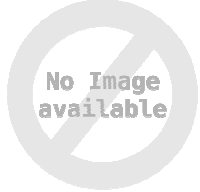
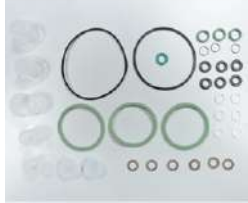

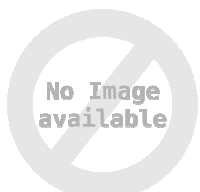
## PUMPS SPARE PARTS

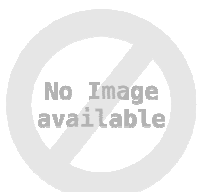
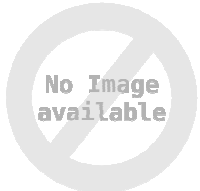
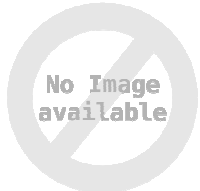
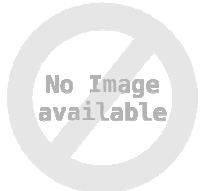
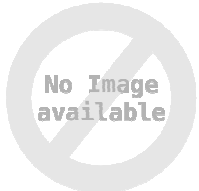
 <p><b>30601</b> F01M 100 275 Kit for CP1 pump Alfa Romeo, FIAT, Lancia</p>	 <p><b>30602</b> F01M 100 275S Kit for CP1 pump with 2 oil seals Mercedes</p>	 <p><b>30603</b> F01M 100 276 Kit for CP1 pump BMW, FIAT, Iveco, Mercedes, Peugeot, Renault</p>	 <p><b>30604</b> F01M 100 277 Kit for CP1 pump BMW, FIAT, Iveco, Mercedes, Peugeot, Renault</p>
 <p><b>30605</b> F01M 100 278 Kit for DRV</p>	 <p><b>30610</b> F01M 101 455=456 Kit for CP1 pump</p>	 <p><b>30620</b> F00N 201 973 Kit for CP3 pump Audi, BMW, Iveco, Mercedes, Opel, Renault, VW</p>	 <p><b>30621</b> F00N 201 974 Kit for CP3 pump Audi, BMW, Iveco, Mercedes, Opel, Renault, VW</p>
 <p><b>30622</b> F00N 201 975 Kit for CP3 pump Audi, BMW, Iveco, Mercedes, Opel, Renault, VW</p>	 <p><b>30623</b> F00N 201 976 Kit for CP3 pump Audi, BMW, Iveco, Mercedes, Opel, Renault, VW</p>	 <p><b>30624</b> F00N 201 977 Kit for CP3 pump Audi, BMW, Iveco, Mercedes, Opel, Renault, VW</p>	 <p><b>30625</b> F00N 201 978 Kit for CP3 pump Audi, BMW, Iveco, Mercedes, Opel, Renault, VW</p>



## PUMPS SPARE PARTS

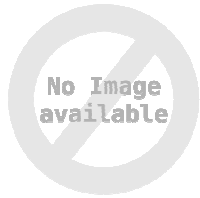

**30626**

F00N 201 979  
Kit for CP3 pump  
Audi, BMW, Iveco, Opel,  
Mercedes, Renault, VW



**30630**

Kit for CP4 Pump  
Mono Plunger  
e.g. 0445 010 506/507/  
508/530/543/546/563/..



**306301**

Kit for CP4 Pump  
Mono Plunger  
e.g. 0445 010 516/552



**306302**

Kit for CP4 Pump  
Mono Plunger  
e.g. 0445 010 767/768



**30631**

Kit for CP4 Pump  
Double Plungers  
e.g. 0445 010 611/  
659/669/673/685



**306311**

Kit for CP4 Pump  
Double Plungers  
e.g. 0445 010 512/  
525/545/559



**306312**

Kit for CP4 Pump  
Double Plungers  
e.g. 0445 010 622/  
649/851



**306315**

Kit for CPN5 Pump  
With oil seals  
e.g. 0445 020 195



**306316**

Kit for CPN5 Pump  
Without oil seals  
e.g. 0445 020 195



**306317**

Kit for CPN5 Pump  
e.g. 0445 020 126



**30641**

ROLLER HOLDER  
For CP4 pump



**30642**

ROLLER  
For CP4 pump



**30643**  
SCREW

For CP4 pump



**30644**

BUSH 22x26x15  
For CP4 pump



**30645**

BUSH 22x26x22  
For CP4 pump



**30646**

BUSH 25x29x21  
For CP4 pump



## PUMPS SPARE PARTS



**30647**  
FLANGED BUSH  
For CP4 pump



## TOOLS



**10120**  
Wrench for valve  
1467C45003 for  
CP4 pumps



**10125**  
Injector Disassembly  
Spanner for  
0445 110 351 / 418 /  
520



**10126**  
Injector Assembly tool  
for  
0445 110 351 / 418 /  
520



**10127**  
Injector Disassembly  
Spanner for 0445 110  
368/ 369/429/646



**10128**  
Injector Assembly tool  
for  
0445 110  
368/369/429/646

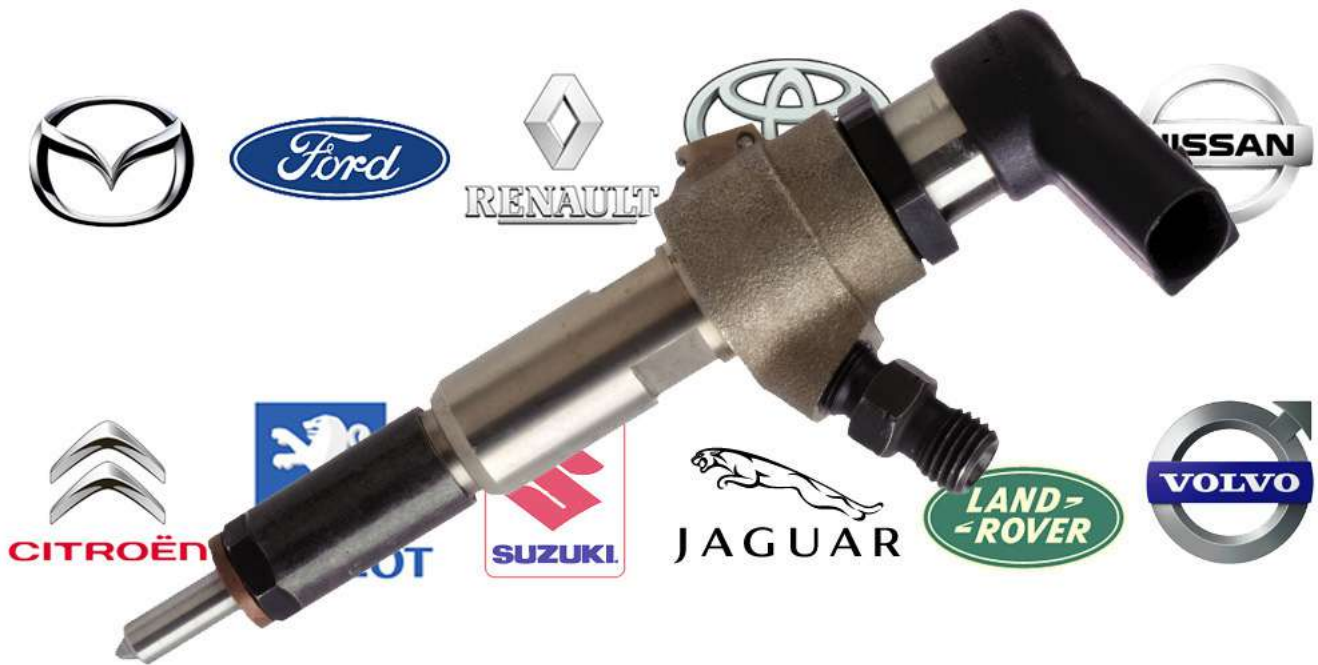

## Nozzles and spares for PIEZO COMMON RAIL INJECTORS AND PUMPS suitable for Continental® system (ex Siemens VDO®)

The worldwide first high-pressure diesel injection system with Piezo injectors was the forerunner Continental® Common Rail Diesel System.

The Piezo Common Rail direct injection system, the first of its kind in the automotive industry, takes common rail technology a step further by advancing the efficiency and power of diesel engines. In 2007 Continental® bought Siemens® VDO Automotive AG becoming one of the top 5 companies in the automotive industry.

These systems are very popular on Citroën®, Ford®, Jaguar®, Land Rover®, Mazda®, Nissan®, Opel®, Peugeot®, Renault®, Suzuki®, Toyota®, Volvo®.

Check out our parts for these injectors and pumps



## NOZZLES

Seven Code	Stamping	Injectors	Main Applications
76501	M0001P153	5WS40252	Engine: LION V6 UPGRADE Jaguar X-Type, Land Rover Freelander and Sport
76502	M0002P156	5WS40249	Engine: DT17 / LION V6 EU4 Citroen C6, Ford, Jaguar X-Type and XJ, Land Rover Discovery and Sport, Peugeot 407 and 607
76503	M0003P153	5WS40156-6 and -Z	Engine: DW10B Citroen C4, C5, C8 and Picasso, Ford C-Max, Focus, Galaxy, Mondeo and S-Max, Peugeot 307, 407, 607 and 807, Volvo C30, S40 and V50
765034	M0004P153	5WS40253	Engine: Lion V8 Land Rover Freelander 3.6L and Range Rover Sport 3.6L
765035	M0005P153	5WS40200	Engine: DW10U MFMA Citroen Dispatch, FIAT Scudo, Peugeot Expert
76504	M0006P154	1875702C91 1875072C91 8C3Z-9E527-DRM	Ford Powerstroke 6.4L
765045	M0008P155	5WS40536	Engine: K9K EU5 Nissan Qashqai and Tiida, Renault Clio, Kangoo, Megane, Modus and Scenic
76505	M0011P162	5WS40539	Engine: VW CR CAYA/B/C Audi A3, Seat Altea, Ibiza, Leon, Skoda Fabia, Octavia, Roomster, Superb and Yeti, VW Caddy, Golf, Jetta, Passat, Polo and Touran
765051	M0012P154	5WS40677	Engine: DV6C Citroen Berlingo, C2, C3, C4, C5, FIAT Scudo, Ford C-Max, Fiesta, Focus, Fusion, Mazda 3, Peugeot 207, 307, 308, 407 and Expert
765053	M0019P140	5WS40745	Engine: PUMA EU5 Citroen Jumper, Ford Ranger and Transit, Land Rover Defender, Mazda BT50 and Peugeot Boxer



## NOZZLES

Seven Code	Stamping	Injectors	Main Applications
765055	M0027P155	A2C59507596	Engine: K9K EU6 1.5L DCi / CDI Mercedes A, B, CLA, GLA and Citan, Nissan Juke, Qashqai and NV200, Renault Captur, Kadjar, Kangoo, Megane, Scénic and Grand Scénic
765057	M0031P145	5WS40932	Engine: MWM Sprint 3.2L Ford Ranger and Troller T4
7650571	M0032P150	A2C335190080	Nissan Interstar 2.3L Cdti, Opel Movano II 2.3L Cdti and Renault Master III 2.3L Dci
7650575 ●●	M0034P150	A2C8139490080	Ford Ranger 2.2L TDCI
76506	M0502P147.6	5WS40087	Engine: K9K EU4 Nissan Qashqai and Tiida, Renault Clio, Kangoo, Megane, Modus and Scenic
76510	M0604P142	5WS40149-Z	Engine: DV4 EU4 Citroen C2 and C3, Ford Fiesta and Fusion, Mazda 2, Peugeot 307 and Toyota Aygo
76511	M1001P152	5WS40086	Engine: LYNX Ford Focus C-Max, Galaxy, Mondeo, S-Max, Tourneo, Transit Connect, Peugeot 407
765115 ●●	M1002P153	5WS40103	Citroen C5 and C6, Jaguar S-Type and XF-Type, Land Rover Discovery and Range Rover Sport, Peugeot 407 and 607
76512	M1003P152	5WS40250	Engine: LYNX_V227 Ford Focus
76515	M1600P150	5WS40080	Engine: IESA NGD 3.0L Ford Ranger and Troller T4/Pantanal
76520	V0600P142	5WS40000-Z	Engine: DW10TD Citroen C5, Xantia, Xsara and Xsara Picasso, Peugeot 206, 306, 307, 406 and Partner, Suzuki Vitara
76530	V0605P144	5WS40148-Z	Engine: DV4TED EU3 Citroen C3 Pluriel, Ford Fusion, Peugeot 1007
76553	V0203P152	03G 130 073D	Volkswagen 2.0L Audi A4, VW Golf and Passat, Seat Leon
76560	V0208P152		

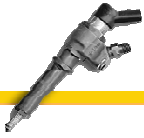

## INJECTORS SPARE PARTS



**36501**  
X11-800-001-001Z  
Min. 25 pcs



**36502**  
X11-800-001-002Z  
Min. 25 pcs



**36503**  
X11-800-001-003Z  
Min. 25 pcs



**36510**  
Leak off connector  
1 way - Plastic



**36511**  
Leak off connector  
2 ways Y - Plastic



**36512**  
Leak off connector  
2 ways - Metal



**36513**  
Leak off connector  
2 ways Y - Metal



**36514**  
Leak off connector  
2 ways Y - Plastic



**36521**  
X11-800-002-001Z  
16 x 7 x 2,5 (Min. 100  
pcs)



**36522**  
X11-800-002-002Z  
15 x 7 x 1,5 (Min. 100  
pcs)



**36523**  
X11-800-002-003Z  
14 x 7,5 x 2 (Min. 100  
pcs)



**36524**  
X11-800-002-004Z  
16 x 7 x 2,5 (Min. 100  
pcs)



**36540**  
Nut  
Ø15



**36541**  
Nut  
Ø19



**36616**  
X11-800-002-  
016Z/017Z  
Fitting +  
Microforated tablet



## CALIBRATION SHIMS

**15160**  
Shim Kit  $\varnothing$  20 –  
Hole  $\varnothing$  13,7  
Total items 210 pcs. –  
24 shims size from  
0,80 to 1,20 (cut 0,02)

**15161**  
Shim Kit  $\varnothing$  5,7 –  
Hole  $\varnothing$  3  
Total items 120 pcs. –  
12 shims size from  
1,25 to 1,80 (cut 0,05)

**15162**  
Shim Kit  $\varnothing$  18 –  
Hole  $\varnothing$  14  
Total items 240 pcs. –  
24 shims size from  
0,90 to 1,13 (cut 0,01)

**15163**  
Shim Kit  
Total items 220 pcs. –  
24 shims size from  
7,76 to 8,18 (cut 0,02)



## PUMPS SPARE PARTS

**36601**  
X39-800-300-001Z  
Citroën, Peugeot

**36604**  
X39-800-300-004Z

**36619**  
X39-800-300-019Z  
Citroën, Ford, Mazda,  
Peugeot, Toyota

**36620**  
X39-800-300-020Z  
Citroën, Ford, Peugeot,  
Volvo

**36650**  
Siemens 1.5L

**SCV9000**  
9805746880

**SR9000**  
A2C59506225

**SR9001**  
A2C2000385980

**PRODUCT UPDATE - September 2012 (last update 25.07.2024)**



Nozzles and spare parts for  
**DELPHI® COMMON RAIL INJECTORS AND PUMPS**  
Suitable for Renault®, Mercedes®, Ford® and Kia® vehicles

Since the first **Delphi®**-equipped Common Rail vehicle was launched in 2001, demand for these high-pressure direct injection vehicles has continued to expand. There are over 5 million Delphi® Common Rail-equipped vehicles currently on the roads. Delphi® supply the worlds largest vehicle manufacturers, including Dacia®, FIAT®, Ford®, Hyundai®, Kia®, Mercedes-Benz®, Peugeot®, Renault® and SSangYong®.

Check out in next page our Common Rail products.



## NOZZLES

Seven Code	Stamping	Part Number	Injector	Main Applications	Control Valve		OEM Kit
					OEM ref.	Seven Code	
703721 ●●	L096 PBD	L096 PBD	EJDR00101Z EJDR00301Z	Ford Mondeo	28239294	199621	7135-652
703722 ●	L097 PBD	L097 PBD	EJBR02801D EJBR03601D	Hyundai Terracan and KIA Carnival	28239294	199621	7135-659
703728 ●	L120 PBD	L120 PBD	EJBR01801A EJBR04001D	Nissan Almera, Kubistar and Micra, Renault Clio, Megane, Scenic, Kangoo and Modus	28239294	199621	7135-647
703729 ●	L121 PBD	L121 PBD	EJBR01302Z EJBR01601Z EJBR02201Z	Ford Focus, Tourneo and Transit Connect	28239294	199621	7135-651
703733 ●	L133 PBD	L133 PBD	EJDR00501Z	Ford Mondeo and Jaguar X-Type	28239294	199621	7135-654
703734 ●	L135 PBD	L135 PBD	EJDR00503Z EJDR00504Z	Ford Mondeo and Jaguar X-Type	28239294	199621	7135-656
70380 ●	L087 PRD	L087 PRD	EJBR01401Z EJBR01701Z EJBR02101Z EJBR04101D	Dacia Logan 1.5L	28239294	199621	7135-644
70382 ●	L136 PRD	L136 PRD	EJBR02501Z EJBR03001D	KIA Bongo, Pregio and Frontier 2.9L CRD	28239294	199621	7135-660
703821 ●●	L137 PRD	L137 PRD	EJBR02401Z EJBR02901D EJBR03701D	Hyundai Terracan and KIA Carnival	28239294	199621	7135-661



## NOZZLES

Seven Code	Stamping	Part Number	Injector	Main Applications	Control Valve		OEM Kit
					OEM ref.	Seven Code	
703822 ●●	L138 PRD	L138 PRD	EJBR02601Z EJBR04601D	SSangYong Rodius, Rexton and Kyron	28239294	199621	7135-649
70383 ●●	L157 PRD	L157 PRD	EJBR03401D	SsangYong Actyon and Kyron	28239294	199621	7135-650
703833 ●●	L163 PRD	L163 PRD	EJBR03301D	JMC Teshun/Transit	28239295	199622	7135-625
703836 ●●	L244 PRD	L244 PRD	EJBR04501D	SSangYong Actyon, Rexton and Kyron	28239295	199622	7135-619
70384 ●	L274 PRD	L274 PRD	EJBR05301D	Dong Feng Xiaobawang	28239295	199622	7135-626
70385 ●	L281 PRD	L281 PRD	EJBR05501D	Kia Bongo	28239295	199622	7135-623
703853 ●●	L286 PRD	L286 PRD	28232234 28237259 R05601D	Dacia Duster, Logan and Sandero, Nissan Pathfinder, Renault Clio, Fluence, Kangoo, Laguna, Megane Scenic and Twingo	28239295	199622	7135-616
703855 ●●	L340 PRD	H340	28235143 R00201D R00202D R00203D	Hyundai i20 and i30, KIA Cee'd, Rio and Venga	28297167	-	7135-582
703856 ●●	L341 PRD	H341	R00301D	SsangYong Korando, Actyon, Rexton and Rodius	28346624 28439531 28626161	199637	7135-583
703857 ●●	L342 PRD	H342	R00101D R00101DP	Citroen C4 Picasso, C4, C5, C8, Jumpy III, FIAT Scudo, Ford C-Max, Focus, Galaxy, Kuga, Mondeo, S- Max, Peugeot 308, 3008, 407, 508, 5008, 807, Expert and RCZ	9308-625C	-	7135-581



## NOZZLES

Seven Code	Stamping	Part Number	Injector	Main Applications	Control Valve		OEM Kit
					OEM ref.	Seven Code	
70386 ●●	L347 PRD	H347	R00002D 28348371 28342997	Jeep Compass and Patriot, Mercedes C, CLS, E, GLK, Sprinter, V, Viano and Vito	28626162	199639	7135-580
			28307309		28343134 28615824	199635	7135-701
70387 ●●	L363 PRD	L363 PRD	28231462	Seat Ibiza, Skoda Fabia and Roomster, Volkswagen Polo	28277709	-	7135-575
703871 ●●	L364 PRD	H364	28264952 28489562	Chevrolet Captiva, Cruze, Orlando	28277576 28525582	-	7135-578
					28264094	-	7135-579
703872 ●●	L365 PRD	H365	28239766 29264951 29489548	Chevrolet Captiva and Opel Antara	28297165	199629	7135-577
70388 ●●	L374 PRD	H374	28229873	Hyundai H1 and Kia Bongo	28277576 28525582	199633	7135-573
703881 ●●	L375 PRD	H375	28236381	Hyundai H1, iLoad, H300, Montana, iMax, i800, Starex	28265514 28346624 28439531 28626161	199637	7135-576
70390 ●●	L381 PRD	L381 PRD	EJBR05102D	Dacia Logan, Renault Clio, Kangoo, Megane, Modus and Scenic and Samsung SM3	28239294	199621	7135-646

Control valves cross references: 9308-918B = 9308-621C = 28239294 ⇒ 199621 and 9308-622A = 9308-622B = 28239295 = 28278897 ⇒ 199622



## NOZZLES

Seven Code	Stamping	Part Number	Injector	Main Applications	Control Valve		OEM Kit
					OEM ref.	Seven Code	
<b>70393</b> ●●	G467	G467	28370681 28565330	Audi, Seat, Skoda and Volkswagen Golf VII	28394612	-	7135-815
<b>70394</b> ●●	G488	G488	28475604 58565337 28654963	MAN TGE, Volkswagen California, Caravelle, Crafter, Multivan, Transporter	28475605	-	7135-835
70395 ●●	G523	G523	28506046 28565336	Audi, Seat, Skoda and Volkswagen Golf VII	28468551	-	7135-816



## PUMPS SPARE PARTS

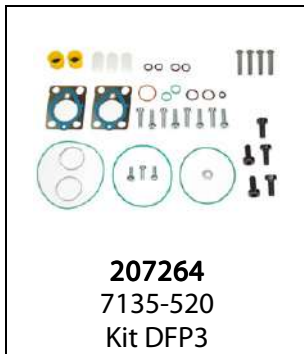

## TOOLS

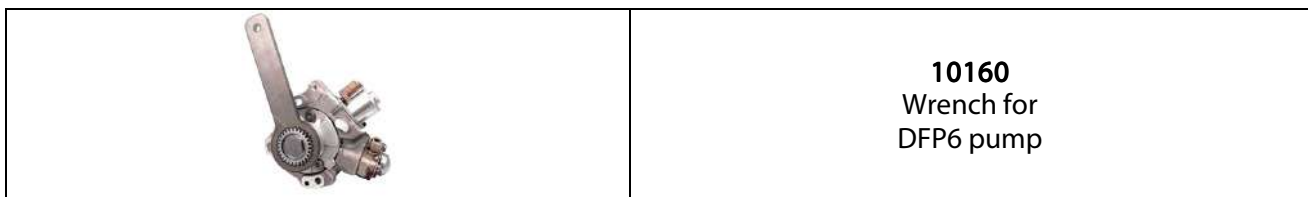

**PRODUCT UPDATE - September 2016 (last update 29.09.2025)**



## Nozzles and spare parts for CATERPILLAR® COMMON RAIL SYSTEM suitable for Perkins® and Mitsubishi® applications

Caterpillar® also developed a Common Rail system capable of multiple injection.

Multiple injection allows optimal combustion and low emissions at all loads.

Caterpillar® CR fuel system is the most effective technology to match emission regulations. The main components are a high pressure (HP) pump, rail, injector and electronics. Caterpillar® C4.4 and C6.6 ACERT Industrial Diesel Engines offer the perfect balance between durability, fuel efficiency and low emissions. These engines use Common Rail fuel systems and advanced control systems to deliver maximum uptime in the harshest environment. Applications powered by C4.4 and C6.6 ACERT engines include: Agriculture, Tractors, Aircraft Ground Support, Grinders, Harvesters, Compactors/Rollers, Compressors, Construction, Cranes, Forestry, Forklifts, General Industrial, Irrigation Equipment, Loaders, Mining. Perkins® is using this system on its 1100 Series. New Engines C7.3 and C9.3 with Common Rail system are also present in the markets worldwide.

Check out in next pages our products suitable for Caterpillar®



## NOZZLES

Seven Code	Stamping	Injector No.	Main applications	Engine
79842	2645A742	257-2500, 266-4434, 276-8280, 282-0480, 289-7500, 293-9580, 321-1080, 10R7667, 2645A703, 2645A704, 2645A708, 2645A742	Perkins	C6.6
79845	2645A745	320-0670, 10R7670, 2645A717, 2645A733, 2645A745	Perkins	C6.6
79847	2645A747	320-0680, 10R7672, 2465A718, 2645A734, 2645A747, 226779M1	Perkins and Massey Ferguson	C4.4/C6.6
79849	2645A749	320-0690, 10R7673 2645A719, 2645A735 2645A749	Perkins	C6.6
79861	32F61-00061	326-4740, 10R7676 32F61-00022 32F61-00061	Mitsubishi	315D/318D/319D
79862	32F61-00062	326-4700, 10R7675 32F61-00060 32F61-00062	Mitsubishi	320D/321D/323D



## INJECTORS SPARE PARTS





## INJECTORS SPARE PARTS



VALVES  
35661 and 35662 are  
slightly different



## PUMPS SPARE PARTS





## CALIBRATION SHIMS

**15140**  
Shim Kit  $\varnothing$  26 –  
Hole  $\varnothing$  22,5  
Total items 240 pcs. –  
24 shims size from  
2,04 to 2,50 (cut 0,02)

**15141**  
Shim Kit  $\varnothing$  26 –  
Hole  $\varnothing$  22,5  
Total items 470 pcs. –  
54 shims size from  
2,04 to 2,50 (cut 0,01)

**15142**  
Shim Kit  $\varnothing$  6,6  
Total items 360 pcs. –  
36 shims size from  
1,30 to 2,00 (cut 0,02)

**15143**  
Shim Kit  $\varnothing$  6,6  
Total items 360 pcs. –  
36 shims size from 2  
to 2,35 (cut 0,01)



## TOOLS

**10105**  
Key for mounting /  
dismounting the  
inner  
ring-nut

**10106**  
Key for mounting /  
dismounting the nut  
To be used with  
10105

**10110**  
12 Faces key for  
dismantling the  
electromagnet.  
Distance between  
faces 27.5 mm



Nozzles and spare parts for  
**BOSCH® PIEZO INJECTORS**  
suitable for many European vehicles

Piezoelectric technology is the modern Common Rail diesel heart. Its innovative technology led to greater efficiency, performance and reduced emissions. The crystal component is fundamentally critical: it generates an electrical charge when a mechanical stress is applied likewise changes its shape when an electrical charge is applied as well. It acts up to 5 times faster than a standard injector solenoid and motion is frictionless. The greatest advantage of Piezo technology is fuel delivery rate and precision since the actuator can be easily activated and deactivated.

At the 2003 Frankfurt Motor Show, Siemens®, Bosch® and Delphi® all launched piezoelectric fuel injection systems. Piezo actuators appeared on Bosch's third-generation Common Rail system on Audi's new 3L V-6 TDI engine that is optional on the A8 flagship.

Check out in next pages our Piezo Common Rail products suitable for Bosch®.



## NOZZLES

Seven Code	Stamping	DLC	Injector No.	Main Applications
71P210 ●●	F00VX20010	DLC	0445 115 026 0445 115 027 0445 115 063 0445 115 064 0445 115 071 0445 115 072 0445 115 075 0445 115 076	Chrysler 300C, Jeep Commander and Grand Cherokee, Mercedes Benz C, CLK, CLS, E, G, GL, GLK, ML, R, Sprinter, Viano and Vito
71P217	F00VX20017	DLC	0445 115 032 0445 115 068 0445 115 069 0445 115 073	Mercedes Benz Sprinter, Viano and Vito
71P307	F00VX30007	DLC	0445 115 008 0445 115 048 0445 115 070	BMW 330, 530, 730, X3 and X5
71P322 ●●	F00VX30022	DLC	0445 115 034 0445 115 036 0445 115 037 0445 115 051 0445 115 052 0445 115 078 0445 115 079 0445 115 082	Audi A4, A6, A8 and Q7, Volkswagen Phaeton and Touareg
71P326 *	F00VX30026	DLC	0445 116 001	BMW 120, 320, 520 and X3
71P341 ●●	F00VX30041	DLC	0445 116 024	BMW 120, 320, 325, 330, 520, 525, 530, 730, X1, X3, X5 and X6
71P379 *	F00VX30079	DLC	0445 117 030	BMW 125, 225, 325, 335, 425, 435, 525, 535, 640, 740, X1, X3, X4, X5 and X6
71P401 *	F00VX40001	DLC		See 71P423
71P414 ●●	F00VX40014	DLC	0445 115 028 0445 115 029 0445 115 030	Volkswagen Crafter
71P421 ●●	F00VX40021	DLC	0445 115 050 0445 115 077	BMW 330, 335, 530, 535, 635, X3, X5 and X6

DLC (Diamond-Like Carbon) = needle with special black coating



## NOZZLES

Seven Code	Stamping	DLC	Injector No.	Main Applications
<b>71P423</b> *	F00VX40023	DLC	0445 115 018 0445 115 019 0445 115 038 0445 115 039 0445 115 040 0445 115 053 0445 115 054 0445 115 057 0445 115 058 0445 115 080 0445 115 081 0445 115 085	Audi A4, A6 and A6 Allroad 2.7 TDI
<b>71P429</b> ••	F00VX40029	DLC	0445 116 004 0445 116 029 0445 116 030 0445 116 034 0445 116 035	Audi A3, A4, A5, A6, Q5 and TT, Seat Altea, Exeo, Leon and Toledo, Skoda Octavia, Superb and Yeti, Volkswagen EOS, Golf V, Golf VI, Jetta, Passat, Scirocco and Tiguan
<b>71P430</b> ••	F00VX40030	DLC	0445 116 007 0445 116 008 0445 116 014 0445 116 015 0445 116 022 0445 116 023	Audi A4, A5, A6, Q5 and Q7, Porsche Cayenne and Volkswagen Touareg
<b>71P460</b> *	F00VX40060	DLC	0445 117 015 0445 117 023	Ford Powerstroke 6.7L for F Series Pickups
<b>71P465</b> ••	F00VX40065	DLC	0445 116 039 0445 116 072	Audi A4, A5, A6, A7, A8 and Q5 3.0 TDI
<b>71P466</b> ••	F00VX40066	DLC	0445 117 021 0445 117 022 0445 117 076	Audi A4, A5, A6, A7, A8 and Q7, Porsche Cayenne and Panamera, Volkswagen Touareg
<b>71P478</b> *	F00VX40078	DLC	0445 117 028 0445 117 070	Audi A6, A6 Allroad, A7 and SQ5 and Porsche Panamera

DLC (Diamond-Like Carbon) = needle with special black coating



## INJECTORS SPARE PARTS



**17005**  
Valve Piezo  
For 0445 115 ...



**170051**  
Valve Piezo  
For 0445 116/117 ...



**17039**  
Leak off connector  
1 way  
(Min. 5 pcs)



**170391**  
Leak off connector  
2 ways  
(Min. 5 pcs)



**170392**  
Leak off connector  
1 way  
(Min. 5 pcs)



**170393**  
Leak off connector  
2 ways  
(Min. 5 pcs)



**17040**  
F00V C17 503  
15 x 7 x 1,5  
(Min. 50 pcs)



**17044**  
F00V P01 004  
13 x 7,3 x 1,5  
(Min. 50 pcs)



**17045**  
F00V P01 008  
12 x 7,7 x 2  
(Min. 50 pcs)



**17046**  
F00V P01 009  
14 x 7,7 x 2 (Min. 50  
pcs)

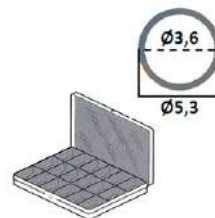

**17075**  
Shim Kit Ø5,3x3,6  
120 pcs. for Piezo



**17080**  
Nut Ø19 – L. 46 – M17  
Hexagonal



**17081**  
Nut Ø19 – L. 47 – M17  
Heptagonal



**17082**  
Nut Ø19 – L. 45,3 – M17  
Octagonal



**17083**  
Nut Ø19 – L. 47 – M17  
Hexagonal



**17090**  
O-ring 22x2 mm  
(Min. 100 pcs)



## INJECTORS SPARE PARTS



## TOOLS



**PRODUCT UPDATE – February 2010 (last update 06.11.2023)**



Nozzles and spare parts for  
**ELECTRONIC UNIT INJECTORS EUI**  
and **SMART INJECTORS**  
Suitable for Delphi® systems

The **Electronic Unit Injector (EUI)** system was developed by Delphi® in the 1990s, for use in large diesel engines, to meet the challenge posed by increasingly stringent emissions legislation. The Delphi® Diesel Electronic Unit Injectors are suitable for nine to 16 liter heavy duty diesel engines used for on- and off-highway applications. This system is very popular on John Deere®, Hyundai®, Land Rover®, Renault® and Volvo® vehicles. The **Smart Injectors** for medium and heavy duty diesel engines are a high pressure, electronically controlled diesel fuel injectors that are designed to be combined with Electric Unit Pump to provide high pressure delivery for “cam in block” engines or engines with separate cam boxes. Smart Injector system is fitted to a wide range of DAF® (MX and PR), Paccar® and Yuchai® applications.

Check out our parts for Electronic Unit Injectors and Smart Injectors.



## NOZZLES

Seven Code	Stamping	Part Number	Injector	Main Applications	Similar to*
70350	L010 PBB	L010 PBB	BEBE4B03001 BEBE4B13001	John Deere	
70351	L011 PBB	L011 PBB	BEBE4B04001 BEBE4B14001	John Deere	
70354	L014 PBB	L014 PBB	BEBE4B10101	Volvo	
70357	L017 PBB	L017 PBB	BEBE4B12004	Volvo	
70358	L018 PBB	L018 PBB	BEBE4B15001	Hyundai	
70360	L024 PBB	L024 PBB	BEBE4B15002	Hyundai	
70361	L029 PBB	L029 PBB	BEBE4B15003	Hyundai	
703699 ••	L023 PBC	L023 PBC	BEBE2A01001	Land Rover Discovery and Defender TD5	
70370 •	L025 PBC	L025 PBC	---	Volvo	L221 PBC
703702 •	L028 PBC	L028 PBC	---	Volvo	L222 PBC
7037025	L038 PBC	L038 PBC	---	Volvo	L052 PBC
703703	L045 PBC	L045 PBC	BEBE4C09101	Hyundai	L232 PBC
7037036	L048 PBC	L048 PBC	---	Hyundai	L233 PBC
703704	L051 PBC	L051 PBC	---	Renault Volvo	L210 PBC
7037040 ••	L052 PBC	L052 PBC	BEBE4D01001 BEBE4D01101 BEBE4D01201 BEBE4D01301 BEBE4D31001	Volvo	L038 PBC
7037041 •	L053 PBC **	L053 PBC	BEBJ1A00001 BEBJ1A00101 BEBJ1A00201 BEBJ1A05001	DAF	
70370415 ••	L055 PBC	L055 PBC	BEBE4D05001 BEBE4D17001	Nissan	
7037044 •	L193 PBC	L193 PBC	BEBE4D08004 BEBE4D16004 BEBE4D24004 BEBE4D24104	Renault Volvo	
7037045 •	L194 PBC	L194 PBC	BEBE4D08003 BEBE4D16003 BEBE4D24003 BEBE4D24103	Volvo	

\* Not interchangeable. Different Volvo series | \*\* Smart Injector



## NOZZLES

Seven Code	Stamping	Part Number	Injector	Main Applications	Similar to*
7037046	L195 PBC	L195 PBC	BEBE4D12001	Volvo	
7037047 ••	L196 PBC	L196 PBC	BEBE4D11001 BEBE4D11101 BEBE4D11201 BEBE4D11301 BEBE4D36001 BEBE4D41001 BEBE4D45001	Renault Volvo	
7037049 •	L209 PBC	L209 PBC	BEBE4D03201	Volvo	L050 PBC
703705 •	L210 PBC	L210 PBC	BEBE4D35002 BEBE4D04002	Renault Volvo	L051 PBC
7037052 •	L211 PBC	L211 PBC	BEBE4D04001	Renault Volvo	
7037055 •	L215 PBC	L215 PBC	BEBE4D08002	Volvo	
703706 •	L216 PBC	L216 PBC	BEBE4D08001 BEBE4D16001	Renault Volvo	
703707 ••	L218 PBC	L218 PBC	BEBE4B17101	John Deere	L021 PBC
703708 •	L221 PBC	L221 PBC	BEBE4C00001 BEBE4C00101	Renault Volvo	L025 PBC
7037082 •	L222 PBC	L222 PBC	BEBE4C01001 BEBE4C01101 BEBE4C02002 BEBE4C02102	Volvo	L028 PBC
7037083 ••	L223 PBC	L223 PBC	BEBE4C02001 BEBE4C03001 BEBE4C03101 BEBE4C14001	Volvo	L026 PBC
703709	L225 PBC	L225 PBC	BEBE4B17103	John Deere	L031 PBC
703710	L226 PBC	L226 PBC	BEBE4C04002	Volvo	L039 PBC
7037105 ••	L229 PBC	L229 PBC	BEBE4C08001	Volvo	L042 PBC
7037109 ••	L233 PBC	L233 PBC	BEBE4C09102	Hyundai	L048 PBC
703711	L234 PBC	L234 PBC	BEBE4C10001	Volvo	
7037112 ••	L240 PBC	L240 PBC	BEBE4D14001 BEBE4D14101	Volvo	

\* Not interchangeable. Different Volvo series | \*\* Smart Injector



## NOZZLES

Seven Code	Stamping	Part Number	Injector	Main Applications	Similar to*
7037113 ••	L242 PBC	L242 PBC	BEBE4C12001 BEBE4C12101	John Deere	
70371135 ••	L311 PBC	L311 PBC	BEBE4D19002	Hyundai	
7037114 •	L322 PBC	L322 PBC	BEBE4D23001 BEBE4D25001	Volvo	
7037115 •	L325 PBC	L325 PBC	BEBE4N01001 (UI)	Renault Volvo	
7037116 ••	L357 PBC	L357 PBC	BEBE4D21001	Hyundai	
7037118 •	L405 PBC **	L405 PBC	BEBJ1A00202 BEBJ1A05002	DAF	
70374	LP004 B	LP004 B	BEBE4B01001	Volvo	

\* Not interchangeable. Different Volvo series | \*\* Smart Injector



## INJECTORS SPARE PARTS





## INJECTORS SPARE PARTS



**PRODUCT UPDATE – December 2009 (last update 20.02.2024)**



## Nozzles and spare parts for Unit Injectors UIS/UPS suitable for Bosch® systems

The **Unit Injector System** (UIS or PDE), also known as the pump-nozzle system, is a diesel injection system developed in 1994 by Bosch®, combining the injection pump and the injector nozzle in a single component. The **Unit Pump System** (UPS or PLD) was introduced in 1995, the feature of the UPS is that each engine cylinder has a unit pump of its own.

These systems are very popular on Audi®, Ford®, Iveco®, Mercedes®, Scania®, Seat®, Skoda®, Volvo® and Volkswagen®.

Check out our parts for Unit Injectors and Unit Pumps.



## NOZZLES

Seven Code	Stamping	Part Number	Injector No.	Main Applications
71887	DLLA155P 572/	0433 171 433	0414 701 004 0414 701 055	Volvo
718872	DLLA155P 572/+			See 71887
718882	DLLA145P 580/	0433 171 439	0414 700 002	Iveco EuroMover, EuroTrakker, EuroTech, Stralis and Trakker
71891	DLLA150P 635	0433 171 470	0414 701 005 /017/105	Scania
718955	DLLA155P 765	0433 171 545		See 718969
718963	DLLA140P 826	0433 171 564	0445 700 005 0445 701 006 /021/053/084	Iveco Cursor 10
718967	DLLA150P 847	0433 171 575	0414 701 007 /020/044/056/ 066/080/081	Scania
718968	DLLA150P 848	0433 171 576	0414 701 008 /019/045/057/ 067/082	Scania
718969	DLLA155P 872	0433 171 584	0414 702 002 /003/005/010/ 017/021	Volvo BH12, FH12, FL12, FM12 and NH12
7189691	DLLA155P 872+			See 718969
718971	DLLA143P 894/	0433 171 596	0414 700 003 /004/008/009	Iveco EuroMover, EuroTrakker, EuroTech, Stralis and Trakker
718972	DLLA152P 903	0433 171 600	0414 702 006 0414 702 018	Volvo FH12 and FM12
718988	DLLA140P 947	0433 171 631	0414 701 013 /022/052/083	Iveco
719055126	DLLA145P 1517	0433 171 937	0414 703 004	Iveco
71905514	DLLA145P 1534	0433 171 946	0414 703 008	Case, Iveco and New Holland
7190552	DLLA145P 1540	0433 171 950	0414 700 006 /007/010	Iveco Stralis and Trakker
719843 ●	DSLA150P 783	0433 175 189	0414 720 005 /007/035	Audi, Seat, Skoda and VW
719853 ●	DSLA150P 800/	0433 175 199	0414 720 015 0414 720 037	Audi, Seat, Skoda and VW
719865 ●	DSLA150P 855	0433 175 227	0414 720 014 /036/086	Ford, Seat and VW
719897 ●	DSLA150P 1042	0433 175 303		Audi, Ford, Seat, Skoda and VW
719898 ●	DSLA150P 1043	0433 175 304	0414 720 013 0414 720 028 0414 720 039	Audi, Seat, Skoda and VW



## NOZZLES

Seven Code	Stamping	Part Number	Injector No.	Main Applications
<b>7198985</b> •	DSLA150P 1045	0433 175 306	0414 720 018 0414 720 029 0414 720 038	Ford Galaxy, Seat Alhambra and VW Sharan
<b>719935</b> •	DSLA150P 1156	0433 175 343	0414 720 124 0414 720 210	VW
<b>719947</b> •	DSLA150P 1247	0433 175 367	0414 720 206 0414 720 208 0414 720 213 0414 720 215	Audi, Seat, Skoda and VW
<b>7199471</b>	DSLA150P 1248	0433 175 368	0414 720 131 /204/209/214/ 216/231	VW
<b>719950</b>	DSLA152P 1287++	0433 175 379	0414 720 401 0414 720 402 0414 720 403 0414 720 404	VW
<b>719957</b> •	DSLA156P 1336	0433 175 402	0414 720 221	VW
<b>719958</b> •	DSLA156P 1381	0433 175 411	0414 720 224 0414 720 232	VW Caddy and Golf IV
<b>719959</b> •	DSLA146P 1409+	0433 175 414	0414 703 003	
<b>719969</b>	DSLA150P 1452	0433 175 428	0414 720 227	VW
<b>719978</b>	DSLA148P 1468	0433 175 429	0414 720 228	VW
<b>7199806</b> •	DSLA150P 1485	0433 175 437	0414 720 311 0414 720 361	VW Touareg
<b>7199807</b> •	DSLA150P 1489	0433 175 441	0414 720 229 0414 720 279	Audi, Seat, Skoda and VW
<b>7199808</b>	DSLA150P 1491	0433 175 444	0414 720 307 0414 720 313	VW
<b>719981</b>	DSLA150P 1499	0433 175 447	0414 720 121 0414 720 312	Audi, Seat, Skoda and VW
<b>7199815</b> •	DSLA150P 1508	0433 175 448	0414 720 304 0414 720 308 0414 720 314 0414 720 364	Audi, Seat, Skoda and VW
<b>719983</b> •	DSLA150P 1585	0433 175 460	0414 720 309	VW
<b>719984</b> •	DSLA150P 1586	0433 175 461	0414 720 310	VW California, Caravelle, Multivan and Transporter



## INJECTORS SPARE PARTS

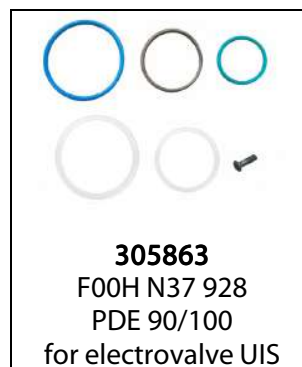
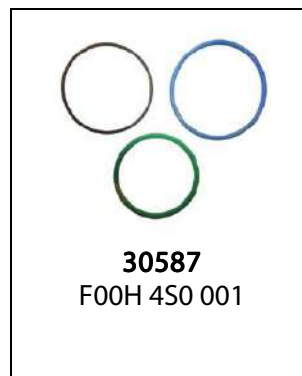
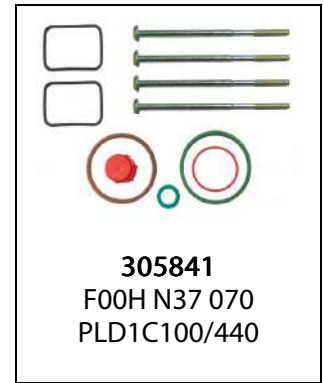
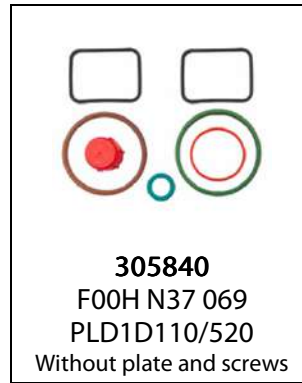



## INJECTORS SPARE PARTS



**305887**  
F00V X99 887  
Part set piston UIS



**305889**  
F00V X99 892  
PLD1B110/520



**305892**  
F00V X99 992  
PDE 100



**305894**  
F00V X99 994  
Part set piston UIS

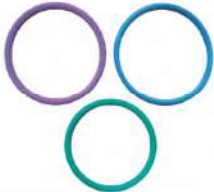

**305895**  
F00V X99 995  
PDE 100



**305896**  
F00V X99 996  
PDE 90



**305898**  
F00V X99 998  
PDE 100



**30590**  
F00V X99 999  
PDE 100

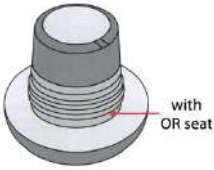

**30760**  
Unit Pump Tappet UIS  
(PDE)  
Total items 60 pcs. -  
12 tappet size from  
14,66 to 14,88 mm  
(cut 0,02)  
For reconditioned units

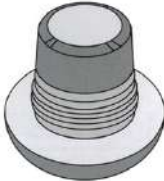

**30761**  
Unit Pump Tappet UIS  
(PDE)  
Total items 60 pcs. -  
12 tappet size from  
14,56 to 14,78 mm  
(cut 0,02)



**30762**  
Unit Pump Tappet UIS  
(PDE)  
Total items 80 pcs. -  
16 tappet size from  
14,80 to 15,10 mm  
(cut 0,02)



**30763**  
Unit Pump Tappet  
UPS (PLD)  
Total items 55 pcs. -  
11 tappet size from  
9,40 to 9,60 mm (cut  
0,02)



**30770**  
Electric Connector  
UIS (PDE)  
For inj. 2 pins  
0414 703 004



## INJECTORS SPARE PARTS

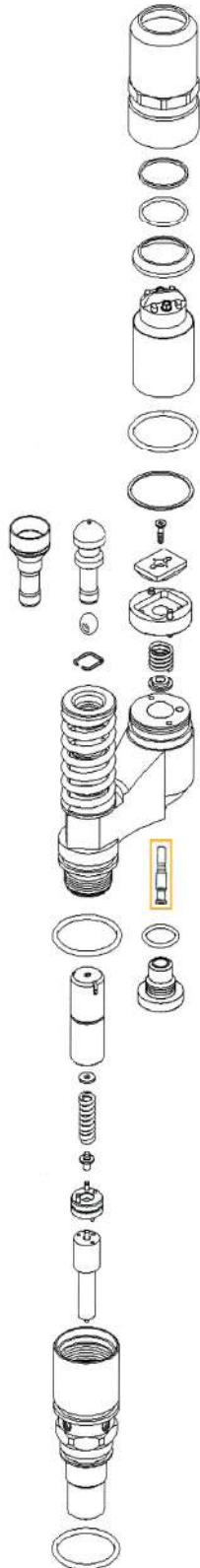

### ←← PISTON VALVE (PDE)

307000	Ø 7,000
307005	Ø 7,005
307010	Ø 7,010
307015	Ø 7,015
307020	Ø 7,020
307025	Ø 7,025
307030	Ø 7,030
307035	Ø 7,035
307040	Ø 7,040
307045	Ø 7,045
307050	Ø 7,050
307055	Ø 7,055
307060	Ø 7,060

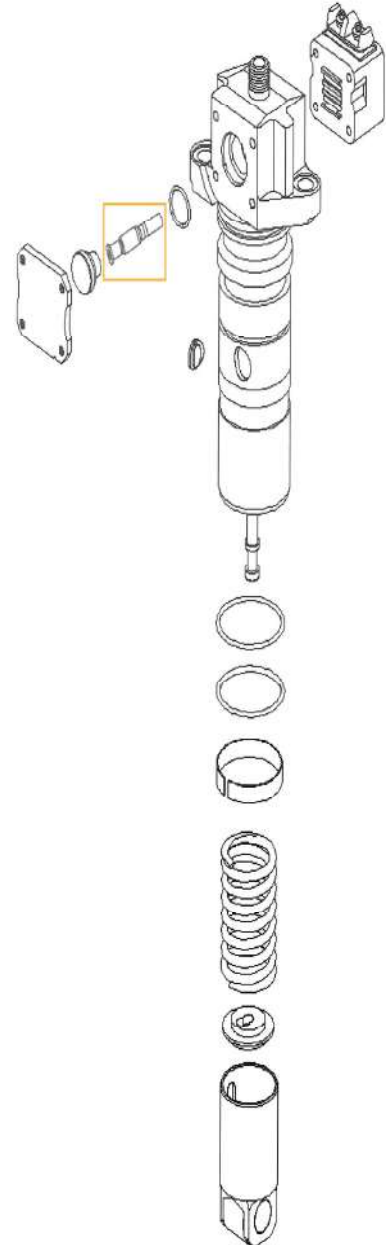

### PISTON VALVE (PLD) →→

307100	Ø 7,000
307105	Ø 7,005
307110	Ø 7,010
307115	Ø 7,015
307120	Ø 7,020
307125	Ø 7,025
307130	Ø 7,030
307135	Ø 7,035
307140	Ø 7,040
307145	Ø 7,045
307150	Ø 7,050
307155	Ø 7,055
307160	Ø 7,060



## INJECTORS SPARE PARTS

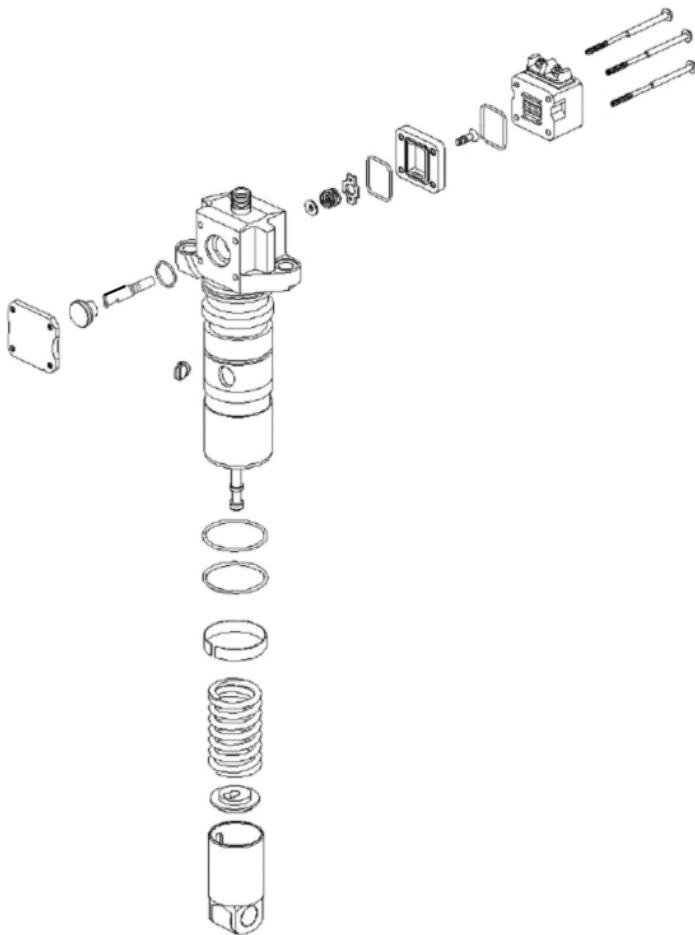

### REGISTER PLATE (PLD + PDE)



307400	3,90 mm
307401	3,91 mm
307402	3,92 mm
307403	3,93 mm
307404	3,94 mm
307405	3,95 mm
307406	3,96 mm
307407	3,97 mm
307408	3,98 mm
307409	3,99 mm
307410	4,00 mm

### UNIT PUMP CHROME PLATE (PLD)



307560	8,00 mm
307561	8,01 mm
307562	8,02 mm

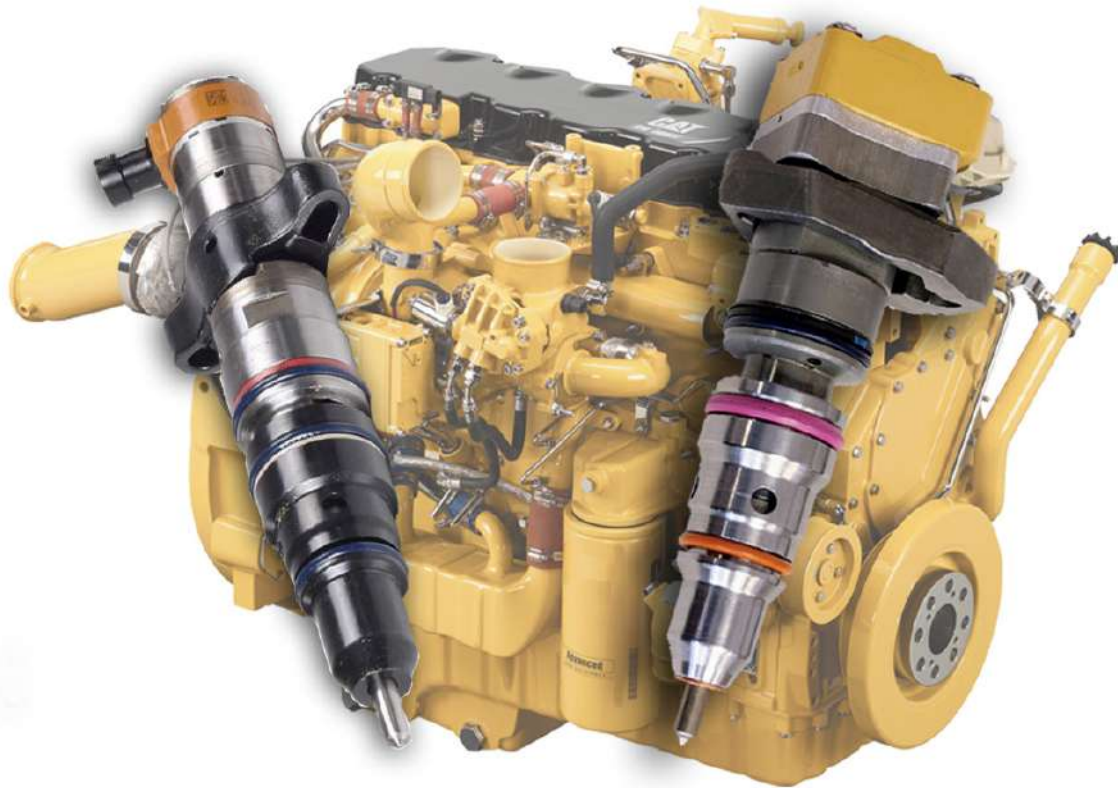

Nozzles and spare parts for  
**HYDRAULIC ELECTRONIC UNIT INJECTORS HEUI**  
Suitable for CAT® C7/9, 3500, 3406/C13/15/18/32 engines

The hydraulically actuated electronic unit injector was developed by Caterpillar® in the early 1990's. HEUI system uses the Electronic Control Module (ECM) in order to guarantee a total electronic control of the fuel delivery, optimizing the engine performance. One of the major benefits of the HEUI injection system was the engine control, as the characteristics of injection events can be controlled independently of any mechanical system. The results were cleaner emissions and greater economy fuel potential.

These systems are very popular on CAT®, Perkins® and John Deere® vehicles.

Check out our parts for these CAT® Injectors.



## NOZZLES suitable for CAT®

Seven Code	Stamping/ Injector Part Number	Holes	Injector Cross Reference	Engines	Fig.	Assembly
79608	10R7224	6x0,165x130°	166-1759, 172-5780, 217-2570, 235-2888, 236-0962	C9 – 950HC	1	79608A Fig. 1A
79611	10R7221 10R9001	5x0,20x128°	229-2018, 229-2019, 242-0616, 243-6846, 293-4065, 328-2575, 387-9440	C-9	2	79611A Fig. 2A
79612	10R7222 10R4764	5x0,24x126°	<b>10R4764</b> = 240-8063, 245-3516, 245-3517, 245-3518, 293-4067, 328-2577, 387-9438  <b>10R7222</b> = 254-4339, 267-3360, 267-3361, 293-4072, 328-2574, 387-9433	C9	2	79612A Fig. 2A
79616	10R7223 10R4844	5x0,23x126°	241-3182, 241-3187, 242-0136, 242-0137, 242-0139, 293-4068, 328-2578, 387-9437	C9 – C-9	2	79616A Fig. 2A
79623	10R7225 10R4763	6x0,20x135°	<b>10R4763</b> = 222-5958, 222-5962, 238-8091, 241-3400, 246-2343, 295-1410, 328-2582, 387-9428  <b>10R7225</b> = 263-8218, 268-1835, 268-1839, 295-1411, 328-2585, 387-9427	C7 - C9 - 329D	2	79623A Fig. 2A
79627	10R4761	6x0,17x136°	222-5959, 222-5961, 236-0973, 243-4502, 295-1408, 328-2583, 387-9430	C7	2	79627A Fig. 2A
79628	10R4762	6x0,17x134°	238-9808, 238-9809, 241-3229, 243-4503, 295-1409, 328-2584, 387-9429	C7	2	79628A Fig. 2A







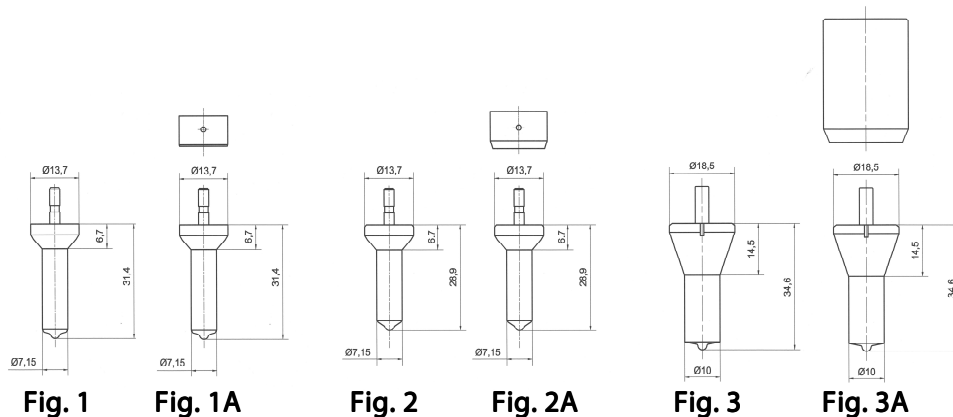



## NOZZLES suitable for CAT®

Seven Code	Stamping/ Injector Part Number	Holes	Injector Cross Reference	Engines	Fig.	Assembly
<b>79701</b> *	<b>10R0955</b>	6x0,22x132° Small Head	OR9803, 176-1150, 191-3005, 211-3025	3406E / C15	3	<b>79701A</b> Fig. 3A 
<b>79702</b>	<b>10R0956</b>	6x0,195x130° Small Head	OR4332, OR4895, OR9256, 102-6236, 109-5038, 117-0481, 118-7929, 118-9027, 140-8951, 159-2631, 191-3002, 211-3022, 10R2782	3406E / C15	3	<b>79702A</b> Fig. 3A 
<b>79703</b> *	<b>10R0957</b>	6x0,23x132° Small Head	OR4119, OR4300, OR4331, OR4894, OR9257, 102-2014, 103-4562, 109-5021, 117-0482, 118-8010, 118-9030, 140-8993, 159-2479, 191-3003, 211-3023, 10R2781, 10R8501	3406E / C15	3	<b>79703A</b> Fig. 3A 
<b>79704</b> *	<b>10R0958</b>	6x0,23x130° Small Head	OR4118, OR4668, OR4893, OR9258, 102-6230, 117-1146, 117-1148, 118-9035, 152-3680, 191-3004, 211-3024, 211-3027, 10R2780, 10R8059, 10R8502	3406E / C15	3	<b>79704A</b> Fig. 3A 
<b>79705</b> *	<b>10R0963</b>	6x0,20x130° Small Head	OR8773, 137-2500, 147-0373, 160-1090, 160-2303, 194-5083, 212-3463, 10R9235	C12 / 3196	3	<b>79705A</b> Fig. 3A 











## NOZZLES suitable for CAT®

Seven Code	Stamping/ Injector Part Number	Holes	Injector Cross Reference	Engines	Fig.	Assembly
79706	10R0967	6x0,18x150° Small Head	0R4987, 116-5414, 161-1785, 212-3462	C10 / 3176C	3	79706A Fig. 3A 
797065 *	10R1000 10R1273	*SPECIAL HOLES* Big Head	10R1000 = 173-9272, 229-5919  10R1273 = 239-4909, 249-0709	3406E / C15	3	797065A Fig. 3A 
79707	10R1275	10x0,255x160° Big Head	0R8215, 139-5221, 144-5665, 150-4455, 229-0192, 250-1312, 373-4087, 392-0212, 20R0848	3516B	3	79707A Fig. 3A 
79708	10R1305	*SPECIAL HOLES* Big Head	249-0707	C13	3	79708A Fig. 3A 
797085	10R1814	*SPECIAL HOLES* Big Head	229-5918	C12	3	797085A Fig. 3A 
79709	10R2977	*SPECIAL HOLES* Big Head	249-0708	C13	3	79709A Fig. 3A 
79710 *	10R3262	6x0,215x132° Small Head	249-0713	C11 / C13	3	79710A Fig. 3A 
797102	10R3265		244-7716, 253-0616	C27	3	797102A Fig. 3A 



## NOZZLES suitable for CAT®

Seven Code	Stamping/ Injector Part Number	Holes	Injector Cross Reference	Engines	Fig.	Assembly
79715	CH12013	6x0,29x130° Small Head		Perkins	3	79715A Fig. 3A 
79717 *	CH12071	6x0,32x131° Small Head	200-1117, 295-9085, 10R8988	Perkins	3	79717A Fig. 3A 
79720 *	CH10948	6x0,30x130° Small Head	276-8307, 10R7231	Perkins	3	79720A Fig. 3A 
79727	20R1271	8x0,29x160° Big Head	134-2601, 172-4672, 229-1099, 250-1307, 386-1759, 392-0207, 0R7977, 10R1277	3508, 3512, 3516	3	79727A Fig. 3A 
79732 *	10R2772 CH11945	6x0,28x133° Small Head	253-0618	C15 - C18 - C32 - Perkins	3	79732A Fig. 3A 
79739	20R2284	6x0,23x130° Small Head	374-0750	C18 - C32	3	79739A Fig. 3A 
79740 *	20R2285	6x0,217x125° Small Head	238-0489 244-7717 253-0617 374-0751	C15 - C27	3	79740A Fig. 3A 



## INJECTORS AND PUMPS SPARE PARTS

 <p><b>35619</b> BLUE O-RING C7 MIN. 10 PCS</p>	 <p><b>356191</b> BLACK O-RING C9 MIN. 10 PCS</p>	 <p><b>356192</b> PISTON GASKETS C7/C9</p>	 <p><b>356194</b> DOWEL C7/C9 Ø1,6x19 MIN. 100 pcs</p>
 <p><b>3561942</b> SPRING C7</p>	 <p><b>3561943</b> SPRING C9</p>	 <p><b>3561944</b> SPRING 3176C/3406E/3500E/ 3508E/3512E/3512E/ 3516E/C10/C13/C15/C16/ C18/C27/C32</p>	 <p><b>356197</b> NOZZLE NUT C7</p>
 <p><b>356198</b> NOZZLE NUT C9</p>	 <p><b>35620</b> C7 INTERNAL KIT</p>	 <p><b>35621</b> C7 EXTERNAL KIT</p>	 <p><b>35625</b> C9 INTERNAL KIT</p>
 <p><b>35626</b> C9 EXTERNAL KIT</p>	 <p><b>35630</b> INTERNAL KIT 3176C-C10-C12</p>	 <p><b>35631</b> EXTERNAL KIT 3176C-C10-C12</p>	 <p><b>35634</b> INTERNAL KIT 3406E-C11-C13-C15- C16-C18-C27-C32</p>



## INJECTORS AND PUMPS SPARE PARTS

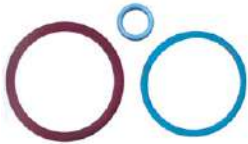

**35635**  
EXTERNAL KIT  
3406E-C11-C13-C15-  
C16-C18-C27-C32



**356351**  
SCREW SET  
3406E-C11-C13-C15-  
C16-C18-C27-C32  
MIN. 10 PCS



**35642**  
INTERNAL KIT  
3500 SERIE



**35643**  
EXTERNAL KIT  
3500 SERIE



**35650**  
KIT C7/9 HYDRAULIC  
PUMPS for 319-0676/7



**356503**  
SCREW SET CAT PUMP  
MIN. 2 PCS

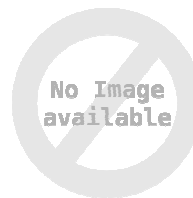

**35655**  
ACTUATOR VALVE

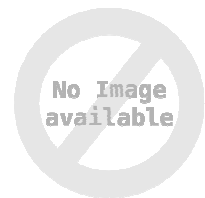

**35657**  
ACTUATOR VALVE

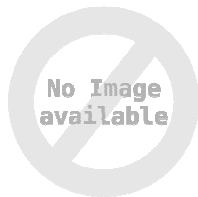

**35659**  
ACTUATOR VALVE



**35660**  
ACTUATOR VALVE



**356601**  
REGULATOR  
ASSEMBLY C7



**356602**  
REGULATOR  
ASSEMBLY C9



**356603**  
SPOOL VALVE C7



**356604**  
SPOOL VALVE C9



**356605**  
DIESEL VALVE C7



**356606**  
DIESEL VALVE C9



## INJECTORS AND PUMPS SPARE PARTS



**S99000**  
SOLENOID 3176C/  
3406E/3500/  
3508E/3512E/3516E



**S99001**  
SOLENOID C7/C9  
214-5427



**S99002**  
SOLENOID 3408/3412



**S99004**  
SOLENOID PUMP  
C7/C9 (w/o seat for O-  
ring) 312-5620



## CALIBRATION SHIMS



**15150**  
Solenoid  
Shim Kit C9  
Total items 40 pcs. –  
12 shims size from  
2,84 to 2,98 (cut 0,02)



## Nozzles and spare parts for CUMMINS® CELECT INJECTORS Suitable for L10, N14, M11 and ISM engines

With more than 80 years of experience in Fuel Systems business, Cummins® is a symbol of efficiency, fuel economy and engine capabilities, while remaining compliant with increasingly strict emission standards. Cummins® advanced Fuel Systems line includes the CELECT (Cummins® Electronic Engine Control) Fuel System.

Released in 1990, it is Cummins® first electronically controlled unit injection system. The CELECT System is a cam driven system that provides high injection pressure and is used on Cummins L10, N14, M11 and ISM engine platforms.

Check out our parts for Cummins® Celect Injectors.



## NOZZLES

Seven Code	Stamping	Injector	Engine
7641071	3076071	3652542	N14
7641081	3079963	3652540	L10
7641091	3084592	3411752	N14
7641101 *	3087791	3411763	M11
7641175	3088175	3411764	N14
7641243 *	3095043	3411753	M11
7641329 ●	3095729	3411754	M11
7641334	3095734	3411755	M11
7641378	3409978	3411762	N14
7641388 *	3411388	3411767	NTA14-E
7641404	3411404	3411758	M11
7641430	3411690	3411765	N14
7641434 *	3411694	3411766	NTA14-E
7641452	3609852	3411761	N14
7641455 *	3609855	3411760	NTA14-E
7641461	3609861	3411759	N14
7641525 ●	3609925	3411756	M11
7641575 ●	4026225	4026222	M11
7641604 ●	4061854	4061851	M11
7641610 ●●	4307525	4307516	M11
7641615 ●●	4307779	4307776	M11
7641620 ●●	4384384	4384360	M11
7641624 ●	4902924	4902921	M11
7641628	4902928	4902925	M11
7641642 ●	4903322	4903319	M11
7641675 ●	4903475	4903472	M11
7641684	4928174	4928171	M11



## INJECTORS SPARE PARTS



\* The plungers are coated to ensure longer life

**PRODUCT UPDATE - October 2020 (last update 08.04.2022)****NAVISTAR**

## Nozzles and spare parts for HEUI® POWER STROKE® INJECTORS suitable for Ford 7.3L and International/Navistar injectors

Power Stroke is a name used by a family of Diesel engines for trucks produced by Ford Motor Company® since 1994. Along with its use in the Ford F-Series (including the Ford Super Duty trucks), applications include the Ford E-Series, Ford Excursion, and Ford LCF commercial trucks. The letter codes for Ford engines are:  
AA, AB, AC, AD, AE and AF.

Navistar® DT engines are used primarily in medium-duty truck and bus applications such as school buses, although some versions have been developed for heavy-duty regional-haul and severe-service applications. Navistar® DT 466E was introduced in 1994, added electronic control to previous, non-electronic DT 466. Also changed over from mechanical fuel injection to Electro-Hydraulic Unit Injection (HEUI). The letter codes for Navistar are BA, BB, BC, BE, BF, BG, BI, BJ, BN and BP. Perkins N1300 and Detroit Diesel 7,6L 40E/8, 7L 40E applications are also fitted with this system.

Check out our components for Power Stroke, HEUI injectors



## NOZZLES AND P&B FOR NAVISTAR DT466E/I530E/DT466/DT530/HT530

Injector No.	Body Code	Seven Code (Nozzle)	Seven Code (Nozzle Assy)	Seven Code (Plunger & Barrell Assy)	Application
181934C1 1819834C1 1823736C94 1824917C2 1824928C94 2593588C91	BA	7641025	441025	886001	International/ Navistar DT466E 230HP-250HP  7.6L Perkins 1300 Series EDi
1824739C1 1824742C91 1824918C2 1824929C94 2593589C91	BB	7641015	441015	886001	International/ Navistar DT466E 175HP-190HP
1824740C1 1824743C91 1824919C2 1824930C94 2593590C91	BC	7641005	441005	886001	International/ Navistar DT466E 195HP-230HP
1824741C2 1824744C94 1824920C2 1824931C94 2593591C91	BD	7641035	441035	887100	International/ Navistar DT466E 250HP-300HP  8.7L Perkins 1300 Series EDi
1824839C94 1829336C1 1829837C2 1829838C94 1829839C93 1829926C2 2593592C91	BE	7641005	441005	886060	International/ Navistar DT466E 175HP-190HP
1830559C91 1830146C92 1830146C93 1830146C94 1830147C2 1830148C2 1293593C91	BF	7641045	441045	887160	International/ Navistar DT466E 250HP-300HP  8.7L Perkins 1300 Series Edi  8.7L AGCO 9675  8.7L Detroit Diesel Series 40E



## NOZZLES AND P&B FOR NAVISTAR DT466E/I530E/DT466/DT530/HT530

Injector No.	Body Code	Seven Code (Nozzle)	Seven Code (Nozzle Assy)	Seven Code (Plunger & Barrell Assy)	Application
1830559C91 1830560C2 1830561C92 1830562C2 1830740C92 1830741C92 1830741C92P 1593594C91 1593595C91	BI	7641016	441016	887160	International/ Navistar DT466E and DT466 175HP-250HP  7.6L Perkins 1300 Series EDi
1830155C91 1830156C91 1830157C1 1830158C1 1830570C91 1830573C2 2593596C91	BJ BG	7641006	441006	887160	International/ Navistar I530E 230HP-300HP  8.7L Perkins 1300 Series Edi  8.7L Detroit Diesel Series 40E
1830691C1 1830692C91 1830693C1 1830694C91 1830694C92P 1830694C93 2593597C91	BN	7641026	441026	887160	International/ Navistar DT530/HT530 250HP-340HP  8.7L Perkins 1300 Series Edi  8.7L Detroit Diesel Series 40E
1836250C1 1836251C91 1836252C91 1836253C1	BP	7641036	441036	887160	International/ Navistar DT466 Transit  7.6L Detroit Diesel Series 40E



## NOZZLES AND P&B FOR FORD POWER STROKE 7.3L / NAVISTAR T444E

Injector No.	Body Code	Seven Code (Nozzle)	Seven Code (Nozzle Assy)	Seven Code (Plunger & Barrell Assy)	Application
1816187C3 1818259C2 1821752C1 1821836C3 1822800C95 1822801C91 F81Z9E527DRM F4TZ9VE527AARM	AA	7641007	441007	886000	International/ Navistar T444E  Ford E-Series Ford F-Series
1822803C1 1823561C1 1824582C94 1824583C97 1825125C1 1825126C1 F81Z9E527BRM F7TZ9E527BRM F61Z9VE527BRM	AB			886060	International/ Navistar T444E  Ford E-Series Ford F-Series
1724474C2 1822890C1 1824472C1 1824473C2 1824455C94 1824456C96	AC			886001	International/ Navistar T444E 210HP-230HP
1823751C91 1823751RX91 1831487C92 1831488C1 1831489C12 1831550C14 1831551C13 F81Z9E527CRM 5C3Z9VE527BRM	AD *			886061	International/ Navistar T444E  Ford E-Series Ford F-Series

\* Recommend replacing AD Injector in #8 cylinder location with AE Injector to eliminate "cackle." This became standard production in 2002.



## NOZZLES AND P&B FOR FORD POWER STROKE 7.3L / NAVISTAR T444E

Injector No.	Body Code	Seven Code (Nozzle)	Seven Code (Nozzle Assy)	Seven Code (Plunger & Barrell Assy)	Application
1833639C1 1833640C1 1833644C1 1833645C1 1833646C92 1833647C91 F81Z9E527EARM XC3Z9E527AARM F61Z9WE527ERM 5C3Z9VE527ARM	AE *	7641007	441007	886061	International/ Navistar T444E  Ford E-Series Ford F-Series
1833643C1 1833641C1	AF			886060	International/ Navistar T444E

\* Long Lead (LL or blue harness connector) Injector. Used in #8 cylinder location to eliminate "cackle."



## INJECTORS SPARE PARTS



**PRODUCT UPDATE – November 2021 (last update 04.08.2022)**



## Spare parts for PENCIL NOZZLES

suitable for Case<sup>®</sup>, CAT<sup>®</sup>, John Deere<sup>®</sup>, Ford<sup>®</sup> applications

We have recently added a bunch of new part numbers to our current mechanical nozzle line: PENCIL nozzles, originally designed by Caterpillar<sup>®</sup> and Stanadyne<sup>®</sup>.

The 1963 introduction of the Pencil Nozzle was a major design change that reduced manufacturing costs and helped spur worldwide sales of Stanadyne<sup>®</sup>. In 1984 Stanadyne introduced the Slim Tip Pencil Nozzle that allowed Ford U.K. and the Japanese farm equipment manufacturer, Kubota, to reconfigure combustion chamber designs for higher horsepower and lower emissions.

There are three main Stanadyne-design pencil nozzle categories. Namely: **STPN** (Standard Pencil Nozzle), **PN** (Pencil nozzle slim with a 5.4 mm slim tip while the standard PN has a 9.5 mm tip) and **PN2** (Pencil Nozzle 2nd generation with larger spring chamber).

Check out in next pages our products



## PENCIL NOZZLES

Seven Code	Stamping	Cross reference	Main applications	OE Brand
59005	100 7556	20R-5169	Caterpillar 3406B 3406C	Caterpillar
59006	100 7558	0R-4339	Caterpillar 3406B 3406C	Caterpillar
59007	100 7559	0R-4340	Caterpillar 3306 3306B	Caterpillar
59009	130 5187	0R-8789	Caterpillar 3406C 3406B	Caterpillar
59010	170 5181	0R-3591	Caterpillar 3306C	Caterpillar
59011	170 5187	0R4124	Caterpillar 3306 3306B	Caterpillar
59024 ●	4W 7015	0R-3419	Caterpillar 3204	Caterpillar
59025 ●	4W 7016	0R-3420	Caterpillar 3208	Caterpillar
59026 ●	4W 7017	0R-3421	Caterpillar 3406B - 3408	Caterpillar
59027 ●	4W 7018	0R-3422	Caterpillar 3406B - 3408	Caterpillar
59028 ●	4W 7019	0R-3536	Caterpillar 3408 - 3412	Caterpillar
59029	4W 7022	0R-3426	Caterpillar 3406B	Caterpillar
59059 ●	7W 7026	0R-3423	Caterpillar 3412	Caterpillar
59060 ●	7W 7032	0R-3424	Caterpillar 3406	Caterpillar
59061	7W 7037	0R-3425	Caterpillar 3406 - 3412	Caterpillar
590768	8N 7003		Caterpillar 3306	Caterpillar
59077 ●	8N 7005		Caterpillar 3304 - 3306	Caterpillar
59305 ●●	20494	AR50783	John Deere 3020, 4020	Stanadyne
59315 ●●	26964	894F-9K546-ACA 26963	Ford 2.5L 4 cyl. HSDI (70PS, 80PS)	Stanadyne
59333 ●	27333	AR89564 27334 = AR89563	John Deere 300 Series	Stanadyne
59336 ●	27336	AR90024 27337 = AR90023	John Deere 300 Series	Stanadyne
59340 ●●	28481	RE36936 28480 = RE36935	John Deere 300 Series	Stanadyne



## PENCIL NOZZLES

Seven Code	Stamping	Cross reference	Main applications	OE Brand
59345 ••	28485	RE38087 28484 = RE36939	John Deere 300 Series	Stanadyne
59350 ••	29279	RE48786 29278 = RE44508	John Deere 6068H	Stanadyne
59355 ••	32262	RE60062 32261 = RE57469	John Deere 4045D & 6068D	Stanadyne
59360 ••	33408	33386 954F-9K546-DC	Ford 2.5L TC 100 PS (MY 95)	Stanadyne
59365 ••	38416	RE531436 38415 = RE507766	John Deere 4045H, 4045T, 6068H, 6068T	Stanadyne



## PENCIL NOZZLES SPARE PARTS







Our complete range of  
**NOZZLES FOR WOODWARD-L'ORANGE® INJECTORS**  
suitable for large engines applications



On 9 September 1933, Rudolf L'Orange and his brother Harro founded the L'Orange Brothers Engine Accessories Company in Stuttgart. They developed and invented new injection systems such as the "zweimengendüse" for continuous atomization. The company was sold to MTU Germany in 1985 and then incorporated into the Tognum Group in 2006 (Rolls-Royce Power Systems AG since 2014). In 2018 Rolls-Royce Power Systems sold the company to its competitor Woodward in the USA. Nowadays **Woodward L'Orange GmbH** is a German engineering manufacturing company headquartered in Stuttgart. It is one of the leading manufacturers of injection systems for large diesel engines worldwide. It developed and produced the first common-rail system for large diesel engines. Woodward L'Orange is a supplier to engine builders from 1000 to 40000 kW. It designs and produces injection parts for most 4-stroke engines for both **marine and power plant applications.**





Check out in next pages our nozzles and parts





## Woodward-L'Orange





SEVEN Part Number	Photo	Stamping	Spray details	Ø	Cooled/Uncooled	Opening Pressure (bar)	Injector Reference	Engine Brand	Engine type	Note and other ref.
<b>NBW6910A</b> <b>NBW6910B</b> <b>NBW6910C</b>		<b>VUM-U910A/E</b>	13x0,43x82°	10	Cooled	360	VUM-G014a	MAN B&W	32/40 CD	IMO1235
		<b>VUM-U910B/E</b>	13x0,39x82°	10	Cooled	360	VUM-G014b	MAN B&W	32/40 CD	IMO1611
		<b>VUM-U910C/E</b>	13x0,41x82°	10	Cooled	360	VUM-G014c	MAN B&W	32/40 CD	IMO1758

<b>NLG10ACA</b>		<b>LT-ACA</b>	8x0,34x145°	6	Uncooled			Rolls Royce Bergen Diesel	K	022822
<b>NLG10ACC</b>		<b>LT-ACC</b>	9x0,35x145°	7	Uncooled					
<b>NLG10ACF</b>		<b>LT-ACF</b>	8x0,35x150°	7	Uncooled			Rolls Royce Bergen Diesel	K	022991
<b>NLG10ADA</b>		<b>LT-ADA</b>	10x0,33x150°	7	Uncooled					
<b>NLG10LBD</b>		<b>LT-LBD</b>	8x0,20x150°	6	Uncooled			Deutz MWM	D440, D441	1215 2978 6.0530.01.3.0003 10 HOLES
<b>NLG10LGQ</b>		<b>LT-LGQ</b>	8x0,35x140°	6	Uncooled					
<b>NLG10LJG</b>		<b>LT-LJG</b>	8x0,25x150°	6	Uncooled					
<b>NLG10LUG</b>		<b>LT-LUG/E</b>	6x0,39x155°	6	Uncooled	350 bar	VTO-G043a	Deutz MWM	D440 (K), D441 (K)	1215 2995 6.0530.01.3.0029
<b>NLG10LXA</b>		<b>LT-LXA</b>	9x0,35+1x0,20	6	Uncooled					
<b>NLG10LXAA</b>		<b>LT-LXA</b>	9x0,35x140°	6	Uncooled			Deutz MWM	D440 (K), D441 (K)	1215 3004 6.0530.01.3.0039
<b>NLG10LXW</b>		<b>LT-LXW</b>	8x0,31x150°	6	Uncooled	350 bar	VTO-G030a			
<b>NLG10LYB</b>		<b>LT-LYB</b>	7x0,36x140°	6	Uncooled			Deutz MWM	D440 (K), D441 (K)	1215 3004 6.0530.01.3.0039
<b>NLG10LZQ</b>		<b>LT-LZQ</b>	8x0,36x140°	6	Uncooled					
<b>NLG10LZR</b>		<b>LT-LZR</b>	8x0,36x150°	6	Uncooled	350 bar	VTO-G030e	MTU	MA956	590 017 05 12
<b>NLG12AAH</b>		<b>LLT-AAH</b>	6x0,51x150°	7	Uncooled					

NLG1490A		LTB-U900A	8x0,42x144°	6	Uncooled					DLLZ145T900a			
NLG15BBE NLG15BBG		LTO-BBEm LTO-BBG	5x0,45x155° 8x0,37x132°	8 8	Uncooled Uncooled			Wärtsilä SWD	TM270 TE290	HL132T37H200P5			
NLG15BEV NLG15BFH NLG15BFW NLG15BGR NLG15BHE NLG15BKV NLG15BKZ NLG15BLJ NLG15BLQ NLG15BMW NLG15BPF NLG15BPJ		LTO-BEV LTO-BFH LTO-BFW LTO-BGR LTO-BHE LTO-BKV LTO-BKZ LTO-BLJ LTO-BLQ LTO-BMW LTO-BPF/E LTO-BPJ	6x0,40x130° 5x0,38x110° 4x0,50x110° 4x0,55x110° 8x0,32x145° 10x0,39x148° 9x0,41x156° 10x0,33x150° 8x0,33x148° 8x0,33x148° 8x0,325x145° 10x0,32x148°	7 7 7 7 7 7 7 7 7 7 7 6	Uncooled Uncooled Uncooled Uncooled Cooled Cooled Cooled Cooled Cooled Uncooled Uncooled Cooled					VTO-G056a VTO-G087a VTO-G061b VTO-G061c VTO-G058a VTO-G087c VTO-G069a VTO-G249a VTO-G087d	Caterpillar MaK Caterpillar MaK Caterpillar MaK Caterpillar MaK MAN B&W MAN B&W MAN B&W Rolls Royce Bergen Diesel MAN B&W MAN B&W MAN B&W MAN B&W	M282AK M281 M331 - M332 M282 23/30 23/30A 28/32 28/32 K 23/30A 23/30 23/30A 23/30A	IMO-17.06



<b>NLG15BGZ</b> <b>NLG15BJH</b> <b>NLG15BNE</b> <b>NLG15BPG/EV</b>		<b>LTO-BGZ</b> <b>LTO-BJH</b> <b>LTO-BNE</b> <b>LTO-BPG</b>	8x0,36x150° 8x0,36x150° 10x0,39x148° 10x0,39x148°	7 7 7 7	Cooled Uncooled Cooled Uncooled	320 bar 320 bar 320 bar 320 bar	VTO-G072 VTO-G071 VTO-G074a VTO-G248a	Wärtsilä Wärtsilä MAN B&W MAN B&W	WV22 WV22 28/32A 28/32A	
<b>NLG16089</b> <b>NLG16090</b>		<b>LTO-U9089a/E</b> <b>LTO-U9089b/E</b>	8x0,29x145° 9x0,28x145°	6 6	Uncooled Uncooled	450 bar 450 bar	VTO-G112a VTO-G112b	MAN B&W MAN B&W	16/24 16/24	
<b>NLG16108</b>		<b>LTO-U9108a</b>	8x0,34x159°	7	Uncooled					
<b>NLG16171</b>		<b>LTO-U9171w/EV1</b>	10x0,32x148°	7	Cooled					



<b>NLG15BME</b> <b>NLG15BMQ</b> <b>NLG15BNG</b>		<b>LTO-BME/E</b> <b>LTO-BMQ</b> <b>LTO-BNG</b>	7x0,43x145° 7x0,41x140° 7x0,41x145°	7 7 7	Uncooled Uncooled Uncooled	355 bar 355 bar 355 bar	VTO-G247a VTO-G247b VTO-G247c	Deutz KHD Deutz KHD Deutz KHD	BVM628 BVM628 BVM628	
<b>NLG15BNZ</b> <b>NLG15BNZ1</b>		<b>LTO-BNZ</b> <b>LTO-BNZ</b>	10x0,36x130° 10x0,36x130°	7 7	Cooled Cooled			Wärtsilä Wichmann Wärtsilä Wichmann	WX28	old version new version
<b>NLG30UBQ</b> <b>NLG30UDR</b> <b>NLG30UFP</b>		<b>LU-UBQ</b> <b>LU-UDR</b> <b>LU-UFP</b>	8x0,45x130° 8x0,40x130° 6x0,45x115°	8 8 8	Uncooled Uncooled Uncooled			Caterpillar MaK Caterpillar MaK Caterpillar MaK	M581 - M582 M451 M451	
<b>NLG60033</b> <b>NLG60Y33</b>		<b>VUM-U933</b> <b>VUM-U933y</b>	1x3,0 1x3,0	8 8	Uncooled Uncooled			MAN B&W MAN B&W	GV23,5/33; GV30/45; VV30/45 GV23,5/33; GV30/45; VV30/45	



<b>NLG60034</b>		<b>VUM-U934a/E</b>	9x0,45x148°	8	Uncooled	400 bar	VUM-G008	MAN B&W	27/38	
<b>NLG60036 NLG600361</b>		<b>VUM-U936a/E VUM-U936b/E</b>	8x0,29x145° 9x0,28x145°	6 6	Uncooled Uncooled			MAN B&W MAN B&W	16/24 16/24	
<b>NLG65906</b>		<b>VUO-U906</b>	1x2.5	8	Uncooled			Wärtsilä SWD	TMA330 TMA336 TEB450	
<b>NLG62BAA NLG62BAC NLG62BAD NLG62BAE</b>		<b>VUO-BAA VUO-BAC VUO-BAD VUO-BAE</b>	6x0,55x130° 6x0,45x130° 6x0,52x110° 6x0,40x110°	7 7 7 7	Uncooled Uncooled Uncooled Uncooled	350 bar 350 bar	VUO-G022c VUO-G022e	Deutz KHD Deutz KHD Deutz KHD Deutz KHD	BVM366 BVM545 BVM358 BVM536 BVM545	273797C3 273797A3 273797D3 273797J3



<b>NLG62BAF</b>		<b>VUO-BAF</b>	6x0,45x110°	7	Uncooled	350 bar	VUO-G022f	Deutz KHD	BVM545	273797K3
<b>NLG62BAG</b>		<b>VUO-BAG</b>	6x0,40x130°	7	Uncooled	350 bar	VUO-G022g	Deutz KHD	BVM545	273797L3
<b>NLG62BAK</b>		<b>VUO-BAK</b>	6x0,35x130°	7	Uncooled	350 bar	VUO-G022k	Deutz KHD	BVM536 BVM545	273797P3
<b>NLG62BAL</b>		<b>VUO-BAL</b>	6x0,30x130°	7	Uncooled	350 bar	VUO-G022l	Deutz KHD	BVM536 BVM545	
<b>NLG62BAM</b>		<b>VUO-BAM</b>	6x0,45x120°	7	Uncooled	350 bar	VUO-G022mb VUO-G022mc	Deutz KHD	BVM545	2032292KZ
<b>NLG62BAN</b>		<b>VUO-BAN</b>	6x0,40x120°	7	Uncooled	350 bar	VUO-G022n	Deutz KHD	BVM545	2032435KZ
<b>NLG62CAA</b>		<b>VUO-CAA</b>	6x0,55x110°	7	Uncooled	350 bar	VUO-G120a	Deutz KHD	BVM358	DO123-19-09-10
<b>NLG62CAB</b>		<b>VUO-CAB</b>	6x0,55x120°	7	Uncooled	350 bar	VUO-G320b	Deutz KHD	BVM350	DO123-19-09-20
<b>NLG62CAC</b>		<b>VUO-CAC</b>	6x0,50x110°	7	Uncooled	350 bar	VUO-G120c	Deutz KHD	BVM358	DO123-19-09-30
<b>NLG62CAD</b>		<b>VUO-CAD</b>	6x0,50x120°	7	Uncooled	350 bar	VUO-G320da	Deutz KHD	BVM350	DO123-19-09-40
<b>NLG62CAE</b>		<b>VUO-CAE</b>	6x0,60x120°	7	Uncooled			Deutz KHD	BVM350	D02020762
<b>NLG65944</b>		<b>VUO-U944a</b>	6x0,60x110°	8	Uncooled	350 bar	VUO-G220aa VUO-G220ab	Deutz KHD	BVM350 BVM358	
<b>NLG65945</b>		<b>VUO-U944b</b>	6x0,60x135°	8	Uncooled	350 bar	VUO-G420b	Deutz KHD	BVM350 BVM358	
<b>NLG65946</b>		<b>VUO-U944c</b>	6x0,65x110°	8	Uncooled	350 bar	VUO-G220c VUO-G220ca	Deutz KHD	BVM350 BVM358	



<b>NLG65909</b>		<b>VUO-U909ay/E</b>	8x0,52x130°	8	Cooled	350 bar	VUO-G055a	Deutz KHD	BVM540	2001658KZ0125-19
<b>NLG65910</b>		<b>VUO-U910a</b>	8x0,52x130°	8	Uncooled	350 bar	VUO-G056a	Deutz KHD	BVM540	2000506KZ0125-19
<b>NLG69A14</b>		<b>VUO-U9014a/E</b>	8x0,54x140°	8	Cooled	350 bar	VUO-G174a	Deutz KHD	BVM640	2092952
<b>NLG67376</b>		<b>VUO-U976a/E</b>	9x0,48x155°	8	Cooled			Deutz MWM Wärtsilä	D510, D511 Vasa 32	
<b>NLG67383</b>		<b>VUO-U976l/E</b>	10x0,48x160°	8	Cooled	350 bar	VUO-G058	Deutz MWM	D510, DG510	
<b>NLG67388</b>		<b>VUO-U976p/E</b>	10x0,48x150°	8	Cooled	350 bar	VUO-G058p	Deutz MWM	D510, DG510	
<b>NLG67389</b>		<b>VUO-U976q/E</b>	10x0,50x150°	8	Cooled	280 bar	VUO-G072	Deutz MWM	D510B	
<b>NLG67808</b>		<b>VUO-U988a/E</b>	9x0,48x155°	8	Uncooled			Wärtsilä	Vasa 32	



NLG65934		VUO-U932c	1x4.0	8	Cooled	350 bar	VUO-G038c/E	Wärtsilä SWD	TM410	
NLG65935		VUO-U932d	1x4.0	8	Cooled	350 bar		Wärtsilä SWD	TM410	
NLG67169		VUO-U969a	1x4.0	8	Cooled	260 bar 260 bar 260 bar 350 bar 350 bar	VUO-G036g VUO-G036r VUO-G136fb VUO-G136ib VUO-G236fb VUO-G236ib	Caterpillar MaK	M551 M552	
NLG66744		VUO-U954acy/E	8x0,60x140°	8	Cooled	260 bar	VUO-G065	Caterpillar MaK	M35	
NLG66746		VUO-U954aey/E	6x0,55x130°	8	Cooled			Caterpillar MaK	M453	
NLG66748		VUO-U954afy/E	8x0,53x140°	8	Cooled			Caterpillar MaK	M453	
NLG66750		VUO-U954by/E	9x0,42x130°	8	Cooled	300 bar	VUO-G080b	Caterpillar MaK	M453	
NLG66752		VUO-U954fy/E	6x0,50x110°	8	Cooled	300 bar	VUO-G080f	Caterpillar MaK	M453	
NLG66754		VUO-U954gy/E	6x0,55x110°	8	Cooled	300 bar	VUO-G080g	Caterpillar MaK	M453	
NLG66954		VUO-U955a/E	5x0,55x120°	8	Uncooled					
NLG66956		VUO-U955b/E	9x0,42x130°	8	Uncooled	260 bar 300 bar	VUO-G047b VUO-G079b	Caterpillar MaK	M453	
NLG66957		VUO-U955c/E	9x0,40x130°	8	Uncooled					
NLG66958		VUO-U955d/E	9x0,45x130°	8	Uncooled					
NLG66959		VUO-U955e/E	5x0,60x110°	8	Uncooled					
NLG66960		VUO-U955f/E	6x0,55x110°	8	Uncooled	260 bar 300 bar 300 bar	VUO-G047f VUO-G247f VUO-G079f	Caterpillar MaK	M453	
NLG66961		VUO-U955g/E	6x0,60x110°	8	Uncooled			Caterpillar MaK	M453	
NLG66962		VUO-U955h/E	6x0,50x110°	8	Uncooled	260 bar 300 bar 300 bar	VUO-G047h VUO-G247h VUO-G079h	Caterpillar MaK	M453	
NLG66963		VUO-U955k/E	8x0,60x140°	8	Uncooled	260 bar	VUO-G066	Caterpillar MaK	M35	
NLG66964		VUO-U955i/E	6x0,45x110°	8	Uncooled					
NLG66965		VUO-U955l/E	8x0,47x140°	8	Uncooled			Caterpillar MaK	M453	
NLG66966		VUO-U955m/E	8x0,53x140°	8	Uncooled					
NLG67050		VUO-U967l	9x0,50x140°	8	Uncooled			S.E.M.T. Pielstick	PA6V280	
NLG67052		VUO-U967ly	9x0,50x140°	8	Uncooled	320 bar	VUP-G007ly	S.E.M.T. Pielstick	PA6V280	Heavy Oil
NLG69013	VUO-U9013by/E		8	Cooled	260 bar	VUO-G048a	Caterpillar MaK	M453		

<b>NLG68C99</b>		<b>VUO-U999c/E</b>	9x0,51x130°	8	Cooled	350 bar	VUO-G054	Deutz MWM	D501	
<b>NLG70034</b>		<b>VUO-U9034b/E</b>	10x0,53x150°	8	Cooled	330 bar	VUO-G087b	Deutz MWM	TBD645	1243 0021
<b>NLG70137</b>		<b>VUO-U9037c/E</b>	12x0,50x150°	8	Cooled	450 bar	VUO-G106c	Caterpillar MaK	M32	E2/1 260 220 012
<b>NLG70196</b>		<b>VUO-U9096C/E</b>	9x0,48x155°	8	Cooled	320 bar	VUO-G097c	Wärtsilä	WV32	009420080

NLG70215		VUO-U9115p/E	10x0,54x158°	9,00	Uncooled			Wärtsilä	W32F	PAAE014820
NLG70241		VUO-U9141d/EV	9x0,335x156°		Uncooled	450 bar	VUO-G260dV	MAN	L21/31	D11.22107-1724
NLG70279		VUO-U9179c/EE	12x0,51x150°	8	Cooled					
NLG70281		VUO-U9181a	10x0,315x156°		Uncooled		VUO-G286A VUO-G315A	MAN	21/31	

<b>NLG72104</b> <b>NLG72106</b> <b>NLG72107</b> <b>NLG72512</b>		<b>VUY-U904a</b> <b>VUY-U904c</b> <b>VUY-U904d</b> <b>VUY-U912</b>	5x0,55x140° 5x0,50x140° 8x0,35x130° 5x0,50x140°	8 8 8 8	Uncooled Uncooled Uncooled Cooled					U1A 5-50 140 U1A 550 140 5 U1A 835 130 U1AF 550 140 52
<b>NLG72115</b> <b>NLG72116</b> <b>NLG72117</b>		<b>VUY-U905a</b> <b>VUY-U905b</b> <b>VUY-U905c</b>	10x0,46x130° 10x0,60x140° 10x0,55x140°	8 8 8	Uncooled Uncooled Uncooled			Hanshin Hanshin Hanshin	6LU32 6LU32 6LU32/6LU38	
<b>NLG72129</b>		<b>VUY-U909</b>	5x0,50x140°	8	Cooled			SKL	NVD48-A2U	U1A550-140

<b>NLG75V01</b>		<b>VVM-U901</b>	1x4.50	11	Uncooled			MAN	RV/40/54	E11221050084
<b>NLG76135</b>		<b>VVO-U935K</b>	10x0,71x150°	10	Uncooled			Wärtsilä	W46	
<b>NLG76143</b> <b>NLG76153</b>		<b>VVO-U943g/E</b> <b>VVO-U953g/E</b>	11x0,59x154° 11x0,59x155°	9 9	Cooled Cooled	450 bar	VVO-G036g	Wärtsilä Wärtsilä SWD	SW38 W38A	
<b>NLG76176</b>		<b>VVO-U976L/E</b>	12x0,57x155°	9	Uncooled					

NLG77A00		VVP-U900a	10x0,60x140°	10	Cooled			S.E.M.T. Pielstick	PC2-5 PC2-6	4 holes
NLG77A01		VVP-U900a	10x0,60x140°	10	Cooled			S.E.M.T. Pielstick	PC2-5 PC2-6	6 holes
NLG77B00		VVP-U900b	10x0,55x140°	10	Cooled			S.E.M.T. Pielstick	PC2-3DF PC2-5LCV	4 holes
NLG77B01		VVP-U900b	10x0,55x140°	10	Cooled			S.E.M.T. Pielstick	PC2-3DF PC2-5LCV	6 holes
NLG77C00		VVP-U900c	10x0,65x140°	10	Cooled			S.E.M.T. Pielstick	PC2-5 PC2-6	4 holes
NLG77C01		VVP-U900c	10x0,65x140°	10	Cooled			S.E.M.T. Pielstick	PC2-5 PC2-6	6 holes
NLG77D00		VVP-U900d	10x0,50x140°	10	Cooled			S.E.M.T. Pielstick	PC2-2 PC2-5	
NLG77E00		VVP-U900e	10x0,52x140°	10	Cooled			S.E.M.T. Pielstick	PC2-2 PC2-5	
NLG77F00		VVP-U900f	9x0,68x140°	10	Cooled			S.E.M.T. Pielstick		
NLG77I00		VVP-U900i	10x0,48x140°	10	Cooled			S.E.M.T. Pielstick		
NLG77L00	VVP-U900l	10x0,625x140°	10	Cooled			S.E.M.T. Pielstick	PC2-5		
NLG77M00	VVP-U900m	10x0,725x140°	10	Cooled			S.E.M.T. Pielstick	PC2-5		
NLG78101		VXP-U901a	10x1,00x140°	13	Cooled					
NLG79105		VXW-U905	1x3.0	10	Cooled					

NLG79200		VWK-U900A/E	11x0,72x150°	11	Uncooled			Caterpillar MaK	M43	J1/1
NLG79201		VWK-U901A/E	11x0,71x150°	11	Cooled			Caterpillar MaK	M43	J4/4

NLG79301		VWM-U901	1x4,5	10	Uncooled			MAN	DZ53/76/80	4D14852
----------	---	----------	-------	----	----------	--	--	-----	------------	---------

NLG79502		VWV-U902a	1x2.0	10	Cooled					
----------	---	-----------	-------	----	--------	--	--	--	--	--





NZS1065		WAF 1065-140-45	10x0,65	12	Cooled			SKL	NVD48-42	G203011200
NZS1070		WAF 1070-140-45	10x0,70	12	Cooled			SKL	NVD48-42	G203017000



Nozzles for  
**HYUNDAI-HiMSEN® INJECTORS**  
Suitable for marine propulsion and generator sets

HiMSEN® is the registered brand name of HYUNDAI®'s own design engine and the abbreviation of "Hi-touch Marine & Stationary Engine". HHI-EMD started engine production in 1979 through a technical partnership. In 2000, they succeeded in developing the HiMSEN® engine. The engine range is very broad, covering a wide power range from 575 kW to over 10,000 kW. Fuel compatibility is excellent because it can be operated not only with residual fuel oil and distillate fuel oil, but also with desulfurized fuel oil and biofuel oil. Applications include marine propulsion systems, marine generator sets, and land-based power plants.

Check out in next page our products.

SEVEN Part Number	Photo	Stamping	Spray details	Ø	Cooled/Uncooled	Engine Brand and Model
NHM1720		H17FV2	10x0,30x134°	7	Cooled	Hyundai-HiMSEN H17/28
NHM2160 NHM2190		H21FV1-5FBM (60°) H21FV1-9FET1 (90°)	10x0,32x148° 10x0,32x148°	7 7	Uncooled Cooled	Hyundai-HiMSEN H21/32
NHM2533		H25FV1	10x0,38x155°	8	Cooled	Hyundai-HiMSEN H25/33
NHM3240 NHM3241 NHM3242		H32FV1 H32FV1 H32FV2	12x0,52x157° 12x0,52x157° 12x0,53x153°	9 10 9	Cooled Cooled Cooled	Hyundai-HiMSEN H32/40





**SEVEN DIESEL S.p.A.**

Via XXV Aprile 51/53/55  
25038 Rovato (BS) - ITALY

T. (+39) 030 7721778 - E. [info@sevendiesel.it](mailto:info@sevendiesel.it)

[www.sevendiesel.it](http://www.sevendiesel.it)

